

# Network Video Recorder

## User's Manual

**V4.4.9**





# Foreword

## General

This manual introduces the functions and operations of the NVR device (hereinafter referred to as "the Device").

## Safety Instructions

The following categorized signal words with defined meaning might appear in the manual.

Signal Words	Meaning
 <b>DANGER</b>	Indicates a high potential hazard which, if not avoided, will result in death or serious injury.
 <b>WARNING</b>	Indicates a medium or low potential hazard which, if not avoided, could result in slight or moderate injury.
 <b>CAUTION</b>	Indicates a potential risk which, if not avoided, could result in property damage, data loss, lower performance, or unpredictable result.
 <b>TIPS</b>	Provides methods to help you solve a problem or save you time.
 <b>NOTE</b>	Provides additional information as the emphasis and supplement to the text.

## Revision History

Version	Revision Content	Release Time
V4.4.9	Add Wi-Fi module and repeater.	December, 2019
V4.4.8	Add new models and security center.	November, 2019
V4.4.7	Add new models.	September, 2019

Version	Revision Content	Release Time
V4.4.6	<ul style="list-style-type: none"> <li>• New UI interfaces and menu tree.</li> <li>• New AI functions.</li> </ul>	July, 2019
V4.4.5	Deletes specifications	June, 2019
V4.4.4	<ul style="list-style-type: none"> <li>• Add models: Cooper 1U (S3), Cooper 1U (S3) with 4 PoE Ports, Compact 1U (S3) with 8 PoE Ports Series.</li> </ul>	August, 2018
V4.4.3	<ul style="list-style-type: none"> <li>• Add Compact 1U 4K(S2) with Wireless and Smart 1U 4K(S2) with Wireless. Add Wi-Fi AP and Repeater functions.</li> <li>• 4K 1.5U (S2) with 24 PoE ports: Add altitude 5,000 meters.</li> </ul>	July, 2018
V4.4.2	<ul style="list-style-type: none"> <li>• Add GDPR information.</li> <li>• Add FCC information.</li> <li>• Update HDD installation.</li> </ul>	June, 2018
V4.3.2	Add Privacy Protection Notice and update About the Manual.	May, 2018
V4.3.1	Add new models and update relevant information.	April, 2018
V4.3.0	Delete old models and add new models. Update relevant information.	October, 2017
V4.2.0	Add models.	September, 2017
V4.1.0	<ul style="list-style-type: none"> <li>• Update POS.</li> <li>• Modify pictures with QR code and SN.</li> </ul>	September, 2017
V4.0.0	<ul style="list-style-type: none"> <li>• Add cloud update module.</li> <li>• Baseline switch and update screen interfaces.</li> </ul>	August, 2017
V3.0.0	<ul style="list-style-type: none"> <li>• Add new modules.</li> <li>• Baseline switch and update screen interfaces.</li> <li>• Add new models.</li> </ul>	May, 2016
V1.0.0	First release.	-

## About the Manual

- The manual is for reference only. If there is inconsistency between the manual and the actual product, the actual product shall prevail.
- We are not liable for any loss caused by the operations that do not comply with the manual.
- The manual would be updated according to the latest laws and regulations of related

regions. For detailed information, see the paper manual, CD-ROM, QR code or our official website. If there is inconsistency between paper manual and the electronic version, the electronic version shall prevail.

- All the designs and software are subject to change without prior written notice. The product updates might cause some differences between the actual product and the manual. Please contact the customer service for the latest program and supplementary documentation.
- There still might be deviation in technical data, functions and operations description, or errors in print. If there is any doubt or dispute, please refer to our final explanation.
- Upgrade the reader software or try other mainstream reader software if the manual (in PDF format) cannot be opened.
- All trademarks, registered trademarks and the company names in the manual are the properties of their respective owners.
- Please visit our website, contact the supplier or customer service if there is any problem occurred when using the device.
- If there is any uncertainty or controversy, please refer to our final explanation.

# Important Safeguards and Warnings

---

The following description is the correct application method of the device. Read the manual carefully before use to prevent danger and property loss. Strictly conform to the manual during application and keep it properly after reading.

## Operating Requirement

- Install the PoE front-end device indoors.
- The device does not support wall mount.
- Do not place and install the device in an area exposed to direct sunlight or near heat generating device.
- Do not install the device in a humid, dusty or fuliginous area.
- Keep its horizontal installation, or install it at stable places, and prevent it from falling.
- Do not drip or splash liquids onto the device; do not put on the device anything filled with liquids, in order to prevent liquids from flowing into the device.
- Install the device at well-ventilated places; do not block its ventilation opening.
- Use the device only within rated input and output range.
- Do not dismantle the device arbitrarily.
- Transport, use and store the device within allowed humidity and temperature range.

## Power Requirement

- Make sure to use the designated battery type. Otherwise there may be explosion risk.
- Make sure to use batteries according to requirements. Otherwise, it may result in fire, explosion or burning risks of batteries!
- To replace batteries, only the same type of batteries can be used.
- Make sure to dispose the exhausted batteries according to the instructions.
- The product shall use electric wires (power wires) recommended by this area, which shall be used within its rated specification.
- Make sure to use standard power adapter matched with this device. Otherwise, the user shall undertake resulting personnel injuries or device damages.

- Use power supply that meets SELV (safety extra low voltage) requirements, and supply power with rated voltage that conforms to Limited Power Source in IEC60950-1. For specific power supply requirements, please refer to device labels.
- Products with category I structure shall be connected to grid power output socket, which is equipped with protective grounding.
- Appliance coupler is a disconnecting device. During normal use, please keep an angle that facilitates operation.

# Table of Contents

Foreword .....	I
Important Safeguards and Warnings .....	IV
Table of Contents .....	VI
1 Features.....	1
1.1 Overview.....	1
1.2 Features.....	1
2 Front Panel and Rear Panel .....	3
2.1 Front Panel .....	3
2.1.1 Beneficio smart 1U/Beneficio smart 1U(S2)/ 4K smart 1U (S2)/ Beneficio 4K Smart 1U(S2) Series.....	3
2.1.2 Beneficio Mini 1U Series.....	3
2.1.3 Compact 1U Wireless Series .....	4
2.1.4 Beneficio Smart 1U with 8 PoE port Series .....	5
2.1.5 4K Smart 1U(S2) with 8 PoE port Series .....	5
2.1.6 Beneficio 1U Series .....	6
2.1.7 Compact 1U (S2)/4K compact 1U (S2)/Compact 1U 4K (S2) Series .....	8
2.1.8 1U/1.5U/2U Series.....	9
2.1.9 Beneficio 1.5U Series.....	10
2.1.10 Beneficio 2U Series .....	11
2.1.11 Beneficio Vertical 1U Series.....	14
2.1.12 Smart 1U 4K (S2) with Wireless Series.....	15
2.1.13 Compact 1U 4K (S2) with Wireless Series .....	16
2.1.14 Cooper 1U (S3) / Cooper 1U (S3) with 4 PoE Ports / Compact 1U (S3) with 8 PoE Ports Series.....	17
2.1.15 4/8ch Compact 1U Series.....	18
2.2 Rear Panel.....	19
2.2.1 Beneficio Smart 1U / Beneficio Smart 1U with 1 PoE port/ Beneficio Smart 1U with 8 PoE ports/ Beneficio Smart 1U with wireless Series .....	19
2.2.2 Beneficio Smart 1U (S2)/ Beneficio 4K Smart 1U(S2) Series.....	21
2.2.3 Beneficio Mini 1U / Beneficio Mini 1U with 1 PoE port/ Beneficio Mini 1U with 8 PoE ports Series.....	22
2.2.4 Compact 1U (S2) / Compact 1U 4K (S2) Series.....	24
2.2.5 Compact 1U Wireless Series .....	25
2.2.6 Beneficio 1U (S2)/ Beneficio 4K 1U(S2) Series .....	26
2.2.7 Beneficio 1U / Beneficio Entry-level 1U/ Beneficio 1U with 1 PoE port/ Beneficio 1U with 8 PoE ports/ Beneficio 1U with 16 PoE Ports Series .....	27
2.2.8 Professional 4K 1U/ Professional 4K 1U with 8 PoE ports/ Professional 4K 1U with 16 PoE ports/4K 1U (S2) with 24 PoE Ports/4K 1U (S2E) with 8 PoE ports/4K 1U (S2E) with 16 PoE ports Series .....	30

2.2.9	Beneficio 1.5U / Beneficio 1.5U with 8 PoE ports/ Beneficio 1.5U with 16 PoE ports Series.....	32
2.2.10	Professional 4K 1.5U/ Professional 4K 1.5U with 16 PoE ports/ Professional 4K 2U / Professional 4K 2U with 16 PoE ports/4K 1.5U (S2) with 24 PoE ports/4K 1.5U (S2E) with 16 PoE Ports/4K 2U (S2E) with 16 PoE ports Series.....	34
2.2.11	4K Smart 1U (S2) Series .....	37
2.2.12	Beneficio Vertical 1U Series.....	38
2.2.13	4K Compact 1U (S2) Series.....	40
2.2.14	4K 1U (S2) Series.....	41
2.2.15	4K 1.5U (S2) Series.....	44
2.2.16	Beneficio 2U/Beneficio 2U with 16 PoE ports Series .....	46
2.2.17	4K 2U (S2) Series.....	48
2.2.18	Smart 1U 4K (S2) with Wireless Series.....	50
2.2.19	Compact 1U 4K (S2) with Wireless Series .....	51
2.2.20	Cooper 1U (S3) / Cooper 1U (S3) with 4 PoE Ports / Compact 1U (S3) with 8 PoE Ports Series.....	52
2.2.21	4/8ch Compact 1U Series.....	53
2.3	Alarm Connection .....	55
2.3.1	Alarm Port .....	55
2.3.2	Alarm input port.....	55
2.3.3	Alarm input and output port.....	56
2.3.4	Alarm relay specifications.....	56
2.4	Bidirectional talk .....	57
2.4.1	Device-end to PC-end.....	57
2.4.2	PC-end to the device-end.....	58
2.5	Mouse Operation .....	58
2.6	Remote Control .....	59
3	Device Installation.....	62
3.1	Device Installation Diagrams.....	62
3.2	Check Unpacked NVR.....	62
3.3	About Front Panel and Rear Panel .....	62
3.4	HDD Installation.....	63
3.4.1	Smart 1U Series.....	63
3.4.2	Mini 1U/Cooper 1U/Compact 1U Series.....	63
3.4.3	1U Series.....	64
3.4.4	1.5U Series .....	64
3.4.5	General 2U Series .....	65
3.4.6	Beneficio Vertical 1U Series.....	65
3.5	CD-ROM Installation.....	66
3.6	Connection Sample .....	68
3.6.1	Beneficio Smart 1U/Beneficio Smart 1U(S2)/ 4K Smart 1U (S2) Series.....	68
3.6.2	Beneficio Mini 1U / Beneficio Mini 1U with 4 PoE Ports / Beneficio mini 1U with 8 PoE Ports Series.....	68
3.6.3	Smart 1U / Compact 1U Wireless Series.....	69
3.6.4	Compact 1U (S2) /4K Compact 1U (S2) / Cooper 1U (S3) / Cooper 1U (S3) with 4 PoE Ports / Compact 1U (S3) with 8 PoE Ports Series .....	69



3.6.5	Beneficio 1U (S2) Series .....	70
3.6.6	Beneficio Entry-level 1U Series .....	70
3.6.7	Beneficio 1U/Professional 4K 1U/ Professional 4K 1U with 8 PoE ports/ Professional 4K 1U with 16 PoE ports/4K 1U (S2) with 24 PoE Ports/4K 1U (S2E) with 8 PoE Ports/4K 1U (S2E) with 16 PoE Ports Series.....	71
3.6.8	General 4K 1U (S2)/Beneficio 4K 1U with 8 PoE ports/4K 1U (S2) with 4 PoE ports/4K 1U (S2) with 8 PoE ports/4K 1U (S2) with 16 PoE ports Series .....	71
3.6.9	Professional 4K 1.5U/ Professional 4K 1.5U with 16 PoE ports/ Professional 4K 2U / Professional 4K 2U with 16 PoE ports/4K 1.5U (S2E) with 16 PoE ports/4K 2U (S2E) with 16 PoE Ports Series.....	72
3.6.10	Beneficio 1.5U / Beneficio 1.5U with 8 PoE ports / Beneficio 1.5U with 16 PoE ports/4K 1.5U (S2) Series.....	72
3.6.11	4K 2U (S2) Series.....	73
3.6.12	Beneficio Vertical 1U Series.....	73
4	Local Basic Operation.....	75
4.1	Getting Started .....	75
4.1.1	Boot up .....	75
4.1.2	Device Initialization.....	75
4.1.3	Reset Password.....	79
4.1.4	Quick Settings .....	86
4.2	Camera.....	109
4.2.1.1	Connection.....	109
4.2.2	Remote Device Initialization.....	114
4.2.3	Short-Cut Menu to Register Camera .....	118
4.2.4	Image.....	118
4.2.5	Encode .....	120
4.2.6	Channel Name .....	123
4.2.7	Remote Upgrade.....	124
4.2.8	Remote Device Info .....	125
4.3	Live View .....	127
4.3.1	Preview.....	127
4.3.2	Navigation bar .....	128
4.3.3	Preview Control Interface .....	130
4.3.4	Wireless Pairing .....	135
4.3.5	Sequence .....	136
4.3.6	Fisheye (Optional) .....	139
4.3.6.3	Test Temperature .....	141
4.3.7	AI Preview Mode.....	142
4.4	PTZ.....	144
4.4.1	PTZ Settings.....	144
4.4.2	PTZ Control.....	146
4.4.3	Configuring PTZ Functions.....	148
4.4.4	Calling PTZ Functions.....	150
4.5	Record File .....	151
4.6	Playback and Search .....	151
4.6.1	Instant Playback.....	151

4.6.2	Search Interface .....	152
4.6.3	Smart Search Playback .....	156
4.6.4	Mark Playback.....	156
4.6.5	Playback Image.....	158
4.6.6	Splice Playback .....	158
4.6.7	File List .....	158
4.6.8	Other Aux Functions .....	160
4.7	AI .....	160
4.7.1	AI Search.....	160
4.7.2	Parameters .....	174
4.7.3	Database.....	208
4.8	Event Manager .....	215
4.8.1	Alarm Info.....	215
4.8.2	Alarm Status .....	215
4.8.3	Alarm Input.....	216
4.8.4	Alarm Control.....	218
4.8.5	Video Detection.....	219
4.8.6	Audio Detect .....	227
4.8.7	Thermal Alarm.....	229
4.8.8	Abnormality.....	232
4.9	POS .....	234
4.9.1	Search .....	235
4.9.2	Settings.....	235
4.10	Operation and Maintenance .....	238
4.10.1	Log .....	238
4.10.2	System.....	239
4.10.3	Network .....	243
4.10.4	Maintenance and Management .....	246
4.11	File Backup.....	253
4.12	Network.....	254
4.12.1	TCP/IP .....	254
4.12.2	Port.....	255
4.12.3	Wi-Fi AP.....	256
4.12.4	Repeater.....	258
4.12.5	PPPoE .....	260
4.12.6	DDNS.....	261
4.12.7	UPnP.....	262
4.12.8	Email .....	264
4.12.9	SNMP .....	266
4.12.10	Multicast .....	268
4.12.11	Alarm Center.....	269
4.12.12	Register .....	269
4.12.13	P2P .....	270
4.13	Storage .....	272
4.13.1	Basic .....	272
4.13.2	Schedule .....	273

4.13.3	HDD .....	273
4.13.4	Record Control .....	274
4.13.5	Advance (HDD Group) .....	274
4.13.6	HDD Detect.....	275
4.13.7	RAID .....	278
4.13.8	Record Estimate.....	283
4.13.9	FTP .....	285
4.14	System.....	286
4.14.1	General.....	286
4.14.2	RS232.....	286
4.15	Security.....	287
4.15.1	Security Status.....	288
4.15.2	System Service.....	290
4.15.3	Attack Defense .....	293
4.15.4	CA Certificate.....	298
4.15.5	Audio/Video Encryption .....	300
4.15.6	Security Warning.....	302
4.16	Account.....	305
4.16.1	User.....	305
4.16.2	Group.....	308
4.16.3	Reset Password .....	309
4.16.4	ONVIF User .....	310
4.17	Output and Display .....	312
4.17.1	Display .....	312
4.17.2	Tour .....	313
4.17.3	Customized Display.....	315
4.18	Audio.....	317
4.18.1	File Manage .....	317
4.18.2	Schedule .....	319
4.18.3	Broadcast .....	320
4.19	USB Device Auto Pop-up .....	322
4.20	Shutdown.....	322
5	Web Operation.....	326
5.1	Network Connection .....	326
5.2	Web Login.....	326
5.3	Reset Password .....	327
5.4	Web Main Menu .....	329
Appendix 1 Glossary.....		332
Appendix 2 FAQ.....		333
Appendix 3 Cybersecurity Recommendations.....		338
Appendix 4 HDD Capacity Calculation.....		341
Appendix 5 Compatible Network Camera List .....		342

# 1 Features

## 1.1 Overview

This series NVR is a high performance network video recorder. This series product support local preview, multiple-window display, recorded file local storage, remote control and mouse shortcut menu operation, and remote management and control function.

This series product supports center storage, front-end storage and client-end storage. The monitor zone in the front-end can be set in anywhere. Working with other front-end devices such as IPC, NVS, this series product can establish a strong surveillance network via the CMS. In the network system, there is only one network cable from the monitor center to the monitor zone in the whole network. There is no audio/video cable from the monitor center to the monitor zone. The whole project is featuring of simple connection, low-cost, low maintenance work.

This series NVR can be widely used in many areas such as public security, water conservancy, transportation and education.

## 1.2 Features

<b>Cloud Upgrade</b>	<ul style="list-style-type: none"><li>• For the NVR connected with the Internet, it supports online upgrade to update applications.</li></ul>
<b>Real-time Surveillance</b>	<ul style="list-style-type: none"><li>• VGA, HDMI port. Connect to monitor to realize real-time surveillance. Some series support TV/VGA/HDMI output at the same time.</li><li>• Short-cut menu when preview.</li><li>• Support popular PTZ decoder control protocols. Support preset, tour and pattern.</li></ul>
<b>Playback</b>	<ul style="list-style-type: none"><li>• Support each channel real-time record independently, and at the same time it can support search, forward play, network monitor, record search, download and etc.</li><li>• Support various playback modes: slow play, fast play, backward play and frame by frame play.</li><li>• Support time title overlay so that you can view event accurate occurred time</li><li>• Support specified zone enlargement.</li></ul>
<b>User Management</b>	<ul style="list-style-type: none"><li>• Each group has different management powers that can be edited freely. Every user belongs to an exclusive group.</li></ul>
<b>Storage</b>	<ul style="list-style-type: none"><li>• Via corresponding setup (such as alarm setup and schedule setup), you can backup related audio/video data in the network video recorder.</li><li>• Support Web record and record local video and storage the file in the client end.</li></ul>
<b>Alarm</b>	<ul style="list-style-type: none"><li>• Respond to external alarm simultaneously (within 200MS), based on user's pre-defined relay setup, system can process the alarm input</li></ul>

	<p>correctly and prompt user by screen and voice (support pre-recorded audio).</p> <ul style="list-style-type: none"> <li>• Support central alarm server setup, so that alarm information can remotely notify user automatically. Alarm input can be derived from various connected peripheral devices.</li> <li>• Alert you via email/sms.</li> </ul>
<b>Network Monitor</b>	<ul style="list-style-type: none"> <li>• Through network, sending audio/video data compressed by IPC or NVS to client-ends, then the data will be decompressed and display.</li> <li>• Support max 128 connections at the same time.</li> <li>• Transmit audio/video data by HTTP, TCP, UDP, MULTICAST, RTP/RTCP and etc.</li> <li>• Transmit some alarm data or alarm info by SNMP.</li> <li>• Support WEB access in WAN/LAN.</li> </ul>
<b>Window Split</b>	<ul style="list-style-type: none"> <li>• Adopt the video compression and digital process to show several windows in one monitor. Support 1/4/8/9/16/ 25/36-window display when preview and 1/4/9/16-window display when playback.</li> </ul>
<b>Record</b>	<ul style="list-style-type: none"> <li>• Support normal/motion detect/alarm record function. Save the recorded files in the HDD, USB device, client-end PC, or network storage server. You can search or playback the saved files at the local-end or via the Web/USB device.</li> </ul>
<b>Backup</b>	<ul style="list-style-type: none"> <li>• Support network backup, USB2.0 record backup function, the recorded files can be saved in network storage server, peripheral USB2.0 device, burner and etc.</li> </ul>
<b>Network Management</b>	<ul style="list-style-type: none"> <li>• Supervise NVR configuration and control power via Ethernet.</li> <li>• Support management via WEB.</li> </ul>
<b>Peripheral Equipment Management</b>	<ul style="list-style-type: none"> <li>• Support peripheral equipment management such as protocol setup and port connection.</li> <li>• Support transparent data transmission such as RS232 (RS-422), RS485 (RS-485).</li> </ul>
<b>Auxiliary</b>	<ul style="list-style-type: none"> <li>• Support switch between NTSC and PAL.</li> <li>• Support real-time system resources information and running statistics display.</li> <li>• Support log file.</li> <li>• Local GUI output. Shortcut menu operation via mouse.</li> <li>• IR control function (For some series product only). Shortcut menu operation via remote control.</li> <li>• Play the video/audio from the network camera or NVS remotely.</li> </ul>

## 2 Front Panel and Rear Panel

### NOTE

The following front panel and rear panel figures are for reference only. The actual product shall prevail.

### 2.1 Front Panel

#### 2.1.1 Beneficio smart 1U/Beneficio smart 1U(S2)/ 4K smart 1U (S2)/ Beneficio 4K Smart 1U(S2) Series

The front panel is shown as in Figure 2-1.

Figure 2-1

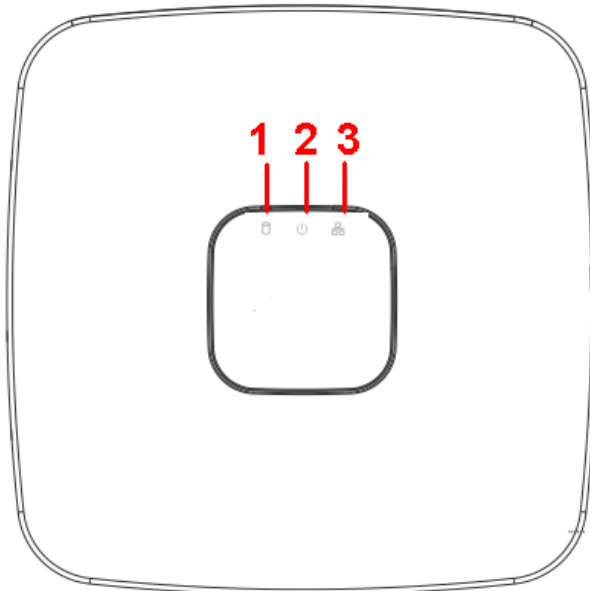

Table 2-1

No.	Name	Function
1	HDD status indicator light	The red light becomes on when HDD is abnormal.
2	Power indicator light	The red light becomes on when the power connection is OK.
3	Network status indicator light	The red light becomes on when the network connection is abnormal.

#### 2.1.2 Beneficio Mini 1U Series

The front panel is shown as in Figure 2-2.

Figure 2-2

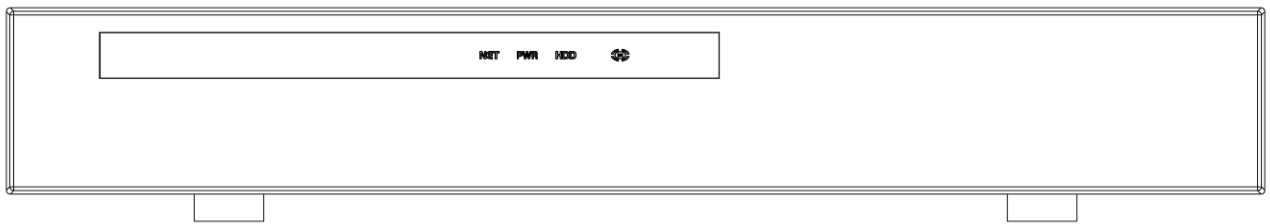

Table 2-2

Icon	Name	Function
NET	Network status indicator light	The red light becomes on when the network connection is abnormal.
PWR	Power indicator light	The red light becomes on when the power connection is OK.
HDD	HDD status indicator light	The red light becomes on when HDD is abnormal.
IR	Remote control receiver	It is to receive signal from the remote control.

### 2.1.3 Compact 1U Wireless Series

The front panel is shown as below. See Figure 2-3.

Figure 2-3

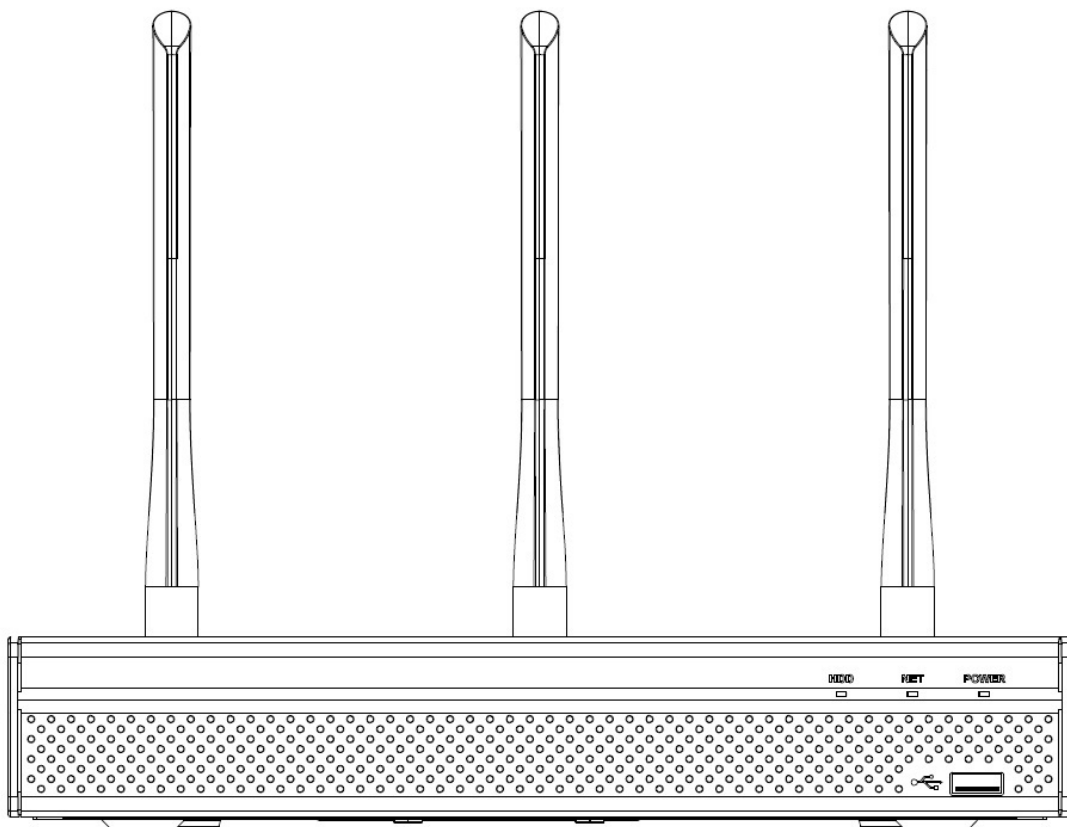



Table 2-3

Icon	Name	Function
HDD	HDD status indicator light	The blue light is on when the HDD is in malfunction.
NET	Network status indicator light	The blue light is on when the network connection is abnormal.
POWER	Power status indicator light	The blue light is on when the power connection is OK.
	USB2.0 port	Connect to peripheral USB 2.0 storage device, mouse, burner and etc.

### 2.1.4 Beneficio Smart 1U with 8 PoE port Series

The front panel is shown as below. See Figure 2-4.

Figure 2-4

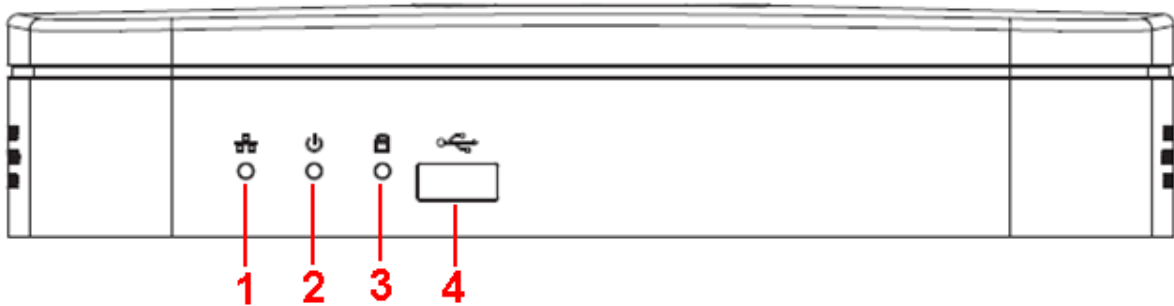

Table 2-4

No.	Name	Function
1	Network status indicator light	The red light becomes on when the network connection is abnormal.
2	Power indicator light	The red light becomes on when the power connection is OK.
3	HDD status indicator light	The red light becomes on when HDD is abnormal.
4	USB	USB port

### 2.1.5 4K Smart 1U(S2) with 8 PoE port Series

The front panel is shown as in Figure 2-5.



Figure 2-5

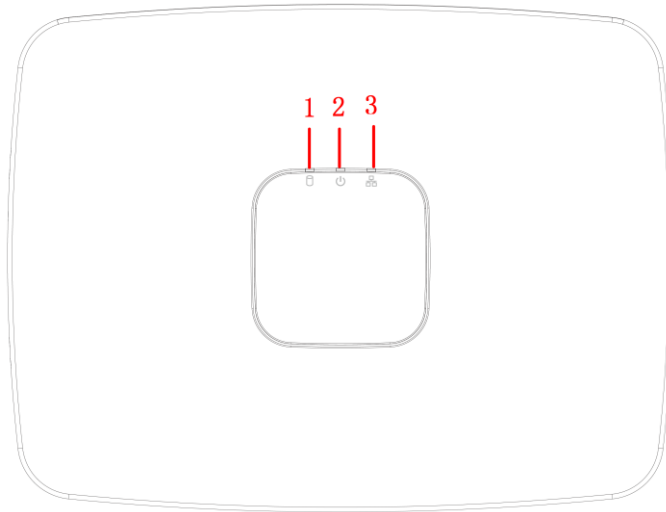

Table 2-5

No.	Name	Function
1	HDD status indicator light	The red light becomes on when HDD is abnormal.
2	Power indicator light	The red light becomes on when the power connection is OK.
3	Network status indicator light	The red light becomes on when the network connection is abnormal.

### 2.1.6 Beneficio 1U Series

The front panel is shown as below. See Figure 2-6.

Figure 2-6

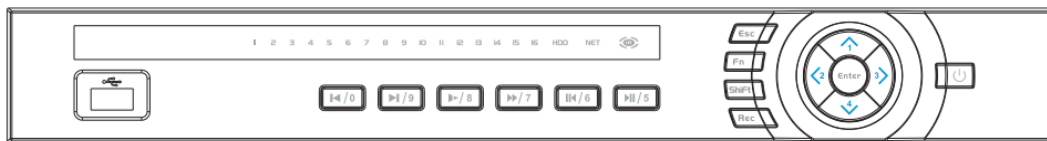







Table 2-6

Icon	Name	Function
Power button		Power button, press this button for three seconds to boot up or shut down NVR.
Shift	Shift	In textbox, click this button to switch between numeral, English(Small/Capitalized), donation and etc.
Up/1 Down/4		Activate current control, modify setup, and then move up and down. Increase/decrease numeral. Assistant function such as PTZ menu.

Icon	Name	Function
		In text mode, input number 1/4 (English character G/H/I).
Left/2 Right/3		Shift current activated control. When playback, click these buttons to control playback bar. In text mode, input number 2(English character A/B/C)/3(English character D/E/F).
ESC	ESC	Go to previous menu, or cancel current operation. When playback, click it to restore real-time monitor mode.
Enter	ENTER	Confirm current operation. Go to default button. Go to menu.
Record	REC	Manually stop/start recording, working with direction keys. or numeral keys to select the recording channel.
Slow play/8		Multiple slow play speeds or normal playback. In text mode, input number 8 (English character T/U/V).
Assistant	Fn	One-window monitor mode, click this button to display assistant function: PTZ control and image color. Backspace function: in numeral control or text control, press it for 1.5seconds to delete the previous character before the cursor. In motion detection setup, working with Fn and direction keys to realize setup. In text mode, click it to switch between numeral, English character(small/capitalized) and etc.
Fast play/7		Various fast speeds and normal playback. In text mode, input number 7 (English character P/Q/R/S).
Play previous/0		In playback mode, playback the previous video. In text mode, input number 0.
Reverse/Pause/6		In normal playback or pause mode, click this button to reverse playback. In reverse playback, click this button to pause playback. In text mode, input number 6 (English character M/N/O).

Icon	Name	Function
Play Next/9	▶	In playback mode, playback the next video. In menu setup, go to down ward of the dropdown list. In text mode, input number 9 (English character W/X/Y/Z).
Play/Pause /5	▶	In normal playback click this button to pause playback. In pause mode, click this button to resume playback. In text mode, input number 5(English character J/K/L).
USB port		To connect USB storage device, USB mouse.
Network abnormal indicator light	Net	Network error occurs or there is no network connection, the light becomes red to alert you.
HDD abnormal indicator light	HDD	HDD error occurs or HDD capacity is below specified threshold value, the light becomes red to alert you.
Record light	1-16	System is recording or not. It becomes on when system is recording.
IR Receiver	IR	It is to receive the signal from the remote control.

### 2.1.7 Compact 1U (S2)/4K compact 1U (S2)/Compact 1U 4K (S2) Series

The series front panel is shown as below. See Figure 2-7.

Figure 2-7

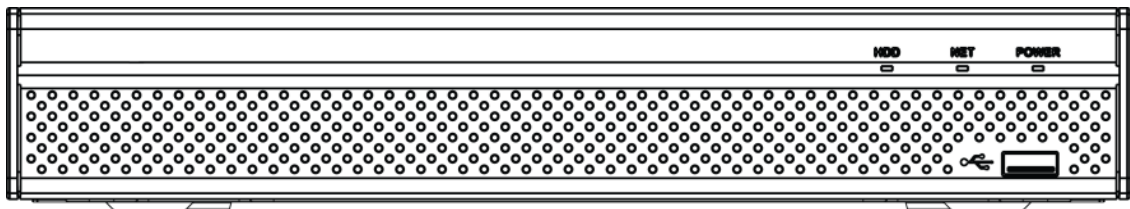



Table 2-7

Icon	Name	Function
STATUS	Status indicator light	The blue light is on when the device is malfunction. <b>Note</b> General compact 1U (S2) series product does not support STATUS indicator light.
HDD	HDD status indicator light	The blue light is on when the HDD is malfunction.
NET	Network status indicator light	The blue light is on when the network connection is abnormal.
POWER	Power status indicator light	The blue light is on when the power connection is OK.

Icon	Name	Function
	USB port	Connect to peripheral USB storage device, mouse and etc.

### 2.1.8 1U/1.5U/2U Series

The 1U series front panel is shown as in Figure 2-8.

Figure 2-8

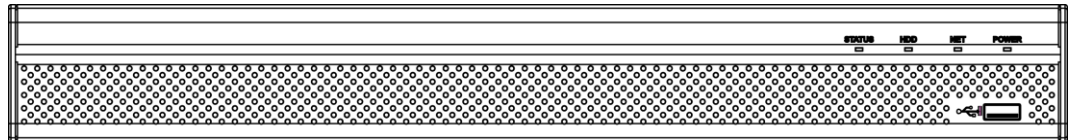

The 1.5U series front panel is shown as in Figure 2-9.

Figure 2-9

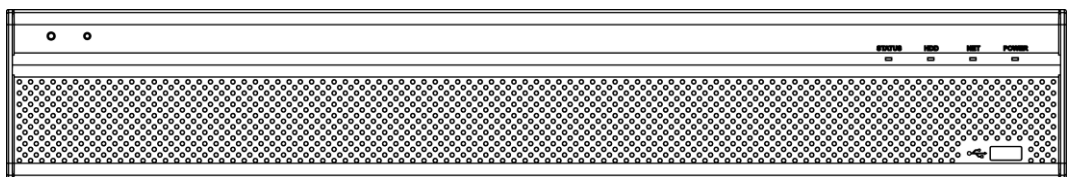

The 2U series front panel is shown as in Figure 2-10.

Figure 2-10

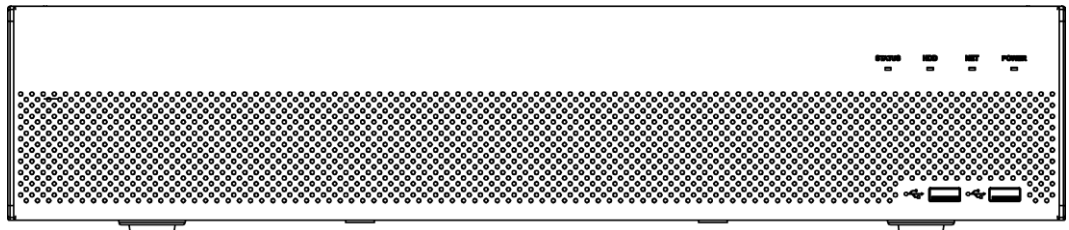



Table 2-8

Icon	Name	Function
STATUS	Status indicator light	The blue light is on when the device is malfunction.
HDD	HDD status indicator light	The blue light is on when the HDD is malfunction.
NET	Network status indicator light	The blue light is on when the network connection is abnormal.
POWER	Power status indicator light	The blue light is on when the power connection is OK.
	USB2.0 port	Connect to peripheral USB 2.0 storage device, mouse, burner and etc.

## 2.1.9 Beneficio 1.5U Series

The front panel is shown as in Figure 2-11.

Figure 2-11

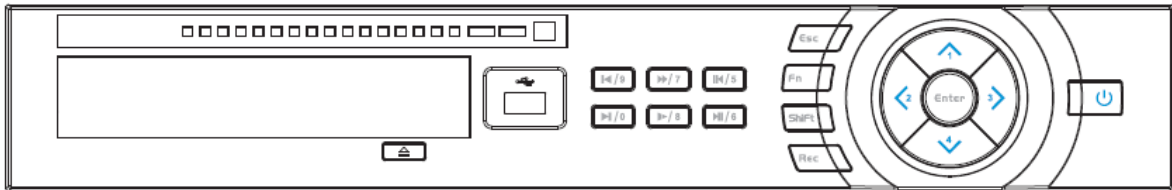



Table 2-9

Icon	Name	Function
Power button		Power button, press this button for three seconds to boot up or shut down NVR.
Shift	Shift	In textbox, click this button to switch between numeral, English(Small/Capitalized),donation and etc.
Up/1 Down/4		Activate current control, modify setup, and then move up and down.
		Increase/decrease numeral.
		Assistant function such as PTZ menu.
		In text mode, input number 1/4 (English character G/H/I).
Left/2 Right/3		Shift current activated control.
		When playback, click these buttons to control playback bar.
		In text mode, input number 2(English character A/B/C). /3(English character D/E/F).
ESC	ESC	Go to previous menu, or cancel current operation.
		When playback, click it to restore real-time monitor mode.
Enter	ENTER	Confirm current operation.
		Go to default button.
		Go to menu.
Record	REC	Manually stop/start recording, working with direction keys. or numeral keys to select the recording channel.
Slow play/8		Multiple slow play speeds or normal playback. In text mode, input number 8 (English character T/U/V).

Icon	Name	Function
Assistant	Fn	One-window monitor mode, click this button to display assistant function: PTZ control and image color.
		Backspace function: in numeral control or text control, press it for 1.5seconds to delete the previous character before the cursor.
		In motion detection setup, working with Fn and direction keys to realize setup.
		In text mode, click it to switch between numeral, English character(small/capitalized) and etc.
Fast play/7	▶▶	Various fast speeds and normal playback. In text mode, input number 7 (English character P/Q/R/S).
Play previous/0	◀	In playback mode, playback the previous video In text mode, input number 0.
Reverse/Pause/6	◀	In normal playback or pause mode, click this button to reverse playback. In reverse playback, click this button to pause playback. In text mode, input number 6 (English character M/N/O).
Play Next/9	▶	In playback mode, playback the next video. In menu setup, go to down ward of the dropdown list. In text mode, input number 9 (English character W/X/Y/Z).
Play/Pause /5	▶	In normal playback click this button to pause playback. In pause mode, click this button to resume playback. In text mode, input number 5(English character J/K/L).
USB port		To connect USB storage device, USB mouse.
Network abnormal indicator light	Net	Network error occurs or there is no network connection, the light becomes red to alert you.
HDD abnormal indicator light	HDD	HDD error occurs or HDD capacity is below specified threshold value, the light becomes red to alert you.
Record light	1-16	System is recording or not. It becomes on when system is recording.

### 2.1.10 Beneficio 2U Series

The Front panel is shown as follows. See Figure 2-12.

Figure 2-12

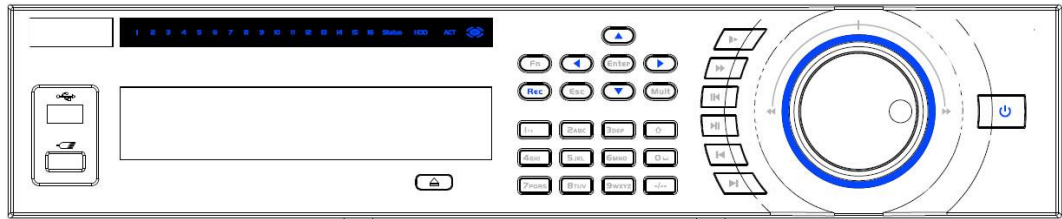



Table 2-10

Icon	Name	Function
Power button		Power button, press this button for three seconds to boot up or shut down NVR.
Number button	0-9	Input Arabic number. Switch channel.
Input number more than 10	-/--	If you want to input a number more than 10, please click this button and then input.
Shift		In textbox, click this button to switch between numeral, English(Small/Capitalized),donation and etc.
		Enable or disable tour.
Up/ Down		Activate current control, modify setup, and then move up and down.
		Increase/decrease numeral.
		Assistant function such as PTZ menu.
Left/ Right		Shift current activated control, and then move left and right.
		When playback, click these buttons to control playback bar.
ESC	ESC	Go to previous menu, or cancel current operation.
		When playback, click it to restore real-time monitor mode.
Enter	ENTER	Confirm current operation.
		Go to default button.
		Go to menu.
Record	REC	Manually stop/start recording, working with direction keys or numeral keys to select the recording channel.
Slow play		Multiple slow play speeds or normal playback.
Assistant	Fn	One-window monitor mode, click this button to display assistant function: PTZ control and image color.

Icon	Name	Function
		Backspace function: in numeral control or text control, press it for 1.5seconds to delete the previous character before the cursor.
		In motion detection setup, working with Fn and direction keys to realize setup.
		In text mode, click it to switch between numeral, English character(small/capitalized) and etc.
		In HDD management interface, you can click it to switch HDD record information and other information (Menu prompt)
		Realize other special functions.
Fast play	»»	Various fast speeds and normal playback.
Play previous	◀	In playback mode, playback the previous video.
Reverse/Pause	◀	In normal playback or pause mode, click this button to reverse playback. In reverse playback, click this button to pause playback.
Play Next	▶	In playback mode, playback the next video. In menu setup, go to down ward of the dropdown list.
Play/Pause	▶	In normal playback click this button to pause playback. In pause mode, click this button to resume playback.
Window switch	<b>Mult</b>	Click it to switch one-window/multiple-window.
Shuttle(outer ring)		In real-time monitor mode it works as left/right direction key. Playback mode, counter clockwise to forward and clock wise to backward.
Jog(inner dial)		Up/down direction key. Playback mode, turn the inner dial to realized frame by frame playback. (Only applies to some special versions.)
USB port		To connect USB storage device, USB mouse.
Remote control indicator light	ACT	Remote control indicator light.
Status indicator light	Status	If there is Fn indicator light, current status indicator light is null.
Power indicator light	PWR	Power indicator light.



Icon	Name	Function
Channel indicator light	1-32	<p><b>For 4/8/16-channel series product.</b> The corresponding channel light becomes on when system is recording.</p> <p><b>For 32/64-channel series product:</b> When the light flashes slowly, it means the corresponding channel of 1-16 channel is recording now (Such as channel 1). When the light flashes fast, it means the corresponding channel of 17-32 channel is recording now (Such as channel 17) When the light becomes on, It means the corresponding 2 channels are recording now (Such as channel 1 and channel 17.).</p> <p><b>The channel indicator light here does not show the status of the 33-64-channel.</b></p>
IR Receiver	IR	It is to receive the signal from the remote control.

### 2.1.11 Beneficio Vertical 1U Series

The front panel is shown as below. See Figure 2-13.

Figure 2-13

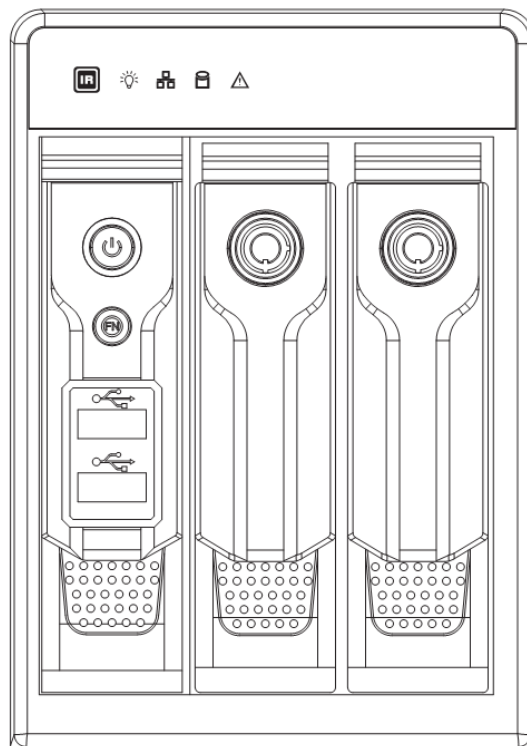







Table 2-11

Name	Icon	Function
Power button	⏻	Power button, press this button for three seconds to boot up or shut down NVR.
Assistant	Fn	● One-window monitor mode, click this button to display

		<p>assistant function: PTZ control and image color.</p> <ul style="list-style-type: none"> <li>● Backspace function: in numeral control or text control, press it for 1.5 seconds to delete the previous character before the cursor.</li> <li>● In motion detection setup, working with Fn and direction keys to realize setup.</li> <li>● In text mode, click it to switch between numeral, English character (small/capitalized) and etc.</li> <li>● In HDD management interface, you can click it to switch HDD record information and other information (Menu prompt)</li> <li>● Realize other special functions.</li> </ul>
USB2.0 port		To connect USB2.0 storage device, USB2.0 mouse, burner and etc.
IR receive window		It is to receive the IR signal from the remote control.
Power indicator light		Power indicator light.
HDD abnormal indicator light		HDD error occurs or HDD capacity is below specified threshold value, the light becomes red to alert you.
Network abnormal indicator light		Network error occurs or there is no network connection, the light becomes red to alert you.
Alarm indicator light		The light becomes on when an alarm occurred.

### 2.1.12 Smart 1U 4K (S2) wih Wireless Series

The front panel is shown as below. See Figure 2-14.

Figure 2-14

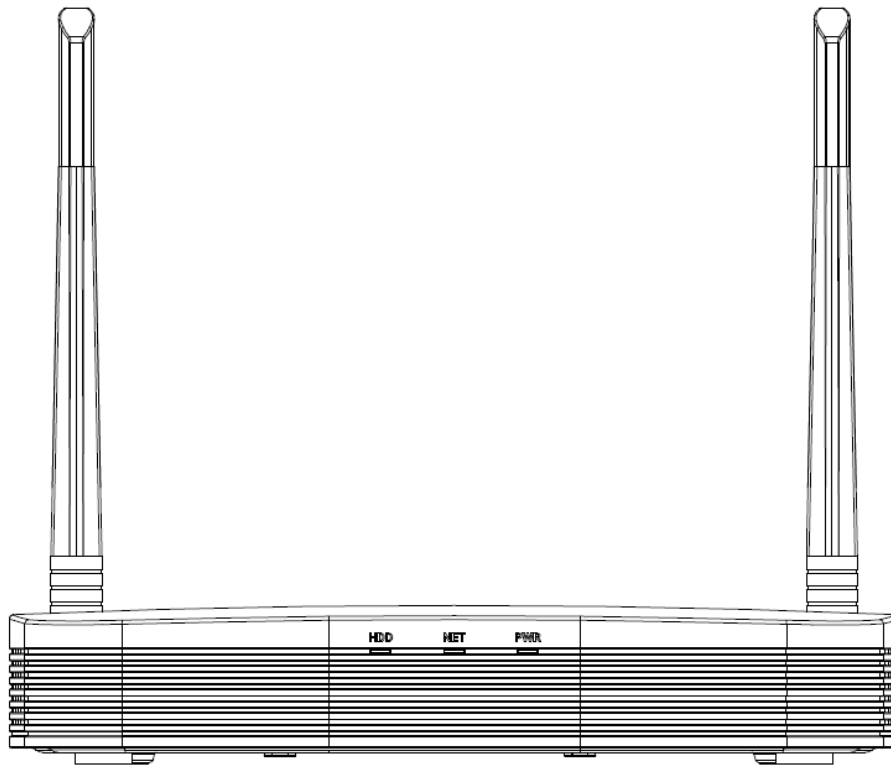

Table 2-12

Icon	Name	Function
HDD	HDD status indicator light	The blue light is on when the HDD is malfunction.
NET	Network status indicator light	The blue light is on when the network connection is abnormal.
PWR	Power status indicator light	The blue light is on when the power connection is OK.

**2.1.13 Compact 1U 4K (S2) wih Wireless Series**

The front panel is shown as below. See Figure 2-15.

Figure 2-15

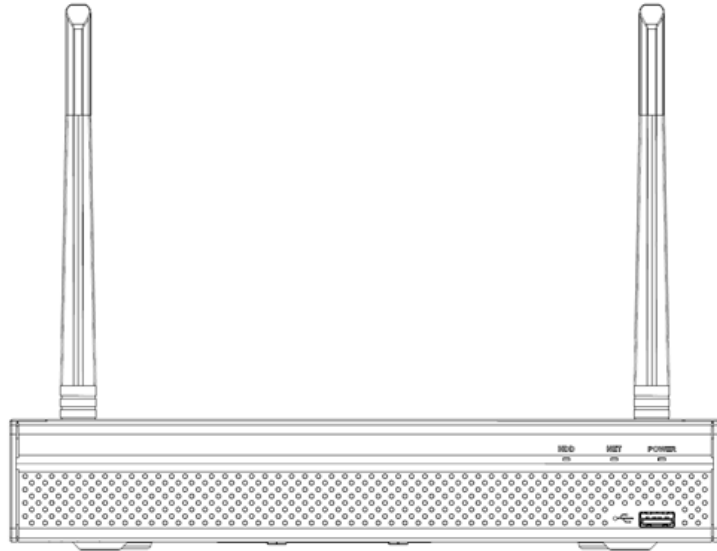



Table 2-13

Icon	Name	Function
HDD	HDD status indicator light	The blue light is on when the HDD is malfunction.
NET	Network status indicator light	The blue light is on when the network connection is abnormal.
POWER	Power status indicator light	The blue light is on when the power connection is OK.
	USB2.0 port	Connect to peripheral USB 2.0 storage device, mouse and etc.

### 2.1.14 Cooper 1U (S3) / Cooper 1U (S3) with 4 PoE Ports / Compact 1U (S3) with 8 PoE Ports Series

The Cooper 1U (S3) / Cooper 1U (S3) with 4 PoE Ports series NVR front panel is shown as in Figure 2-16.

Figure 2-16

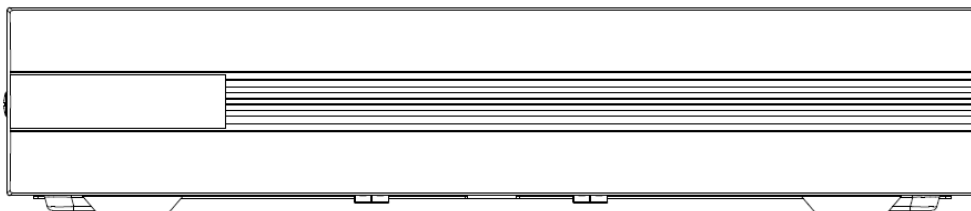

The Compact 1U (S3) with 8 PoE Ports series NVR front panel is shown as in Figure 2-17.

Figure 2-17

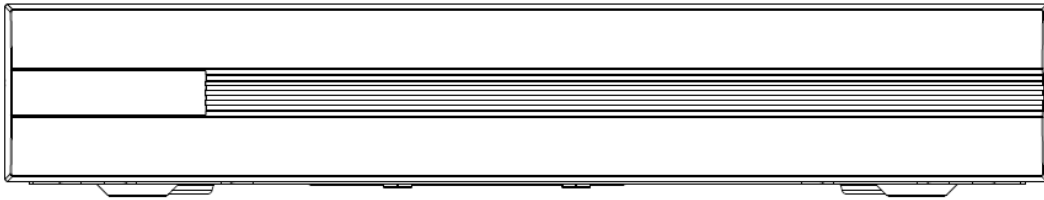

### 2.1.15 4/8ch Compact 1U Series

The 4/8ch Compact 1U series NVR front panel is shown as in Figure 2-18.

Figure 2-18

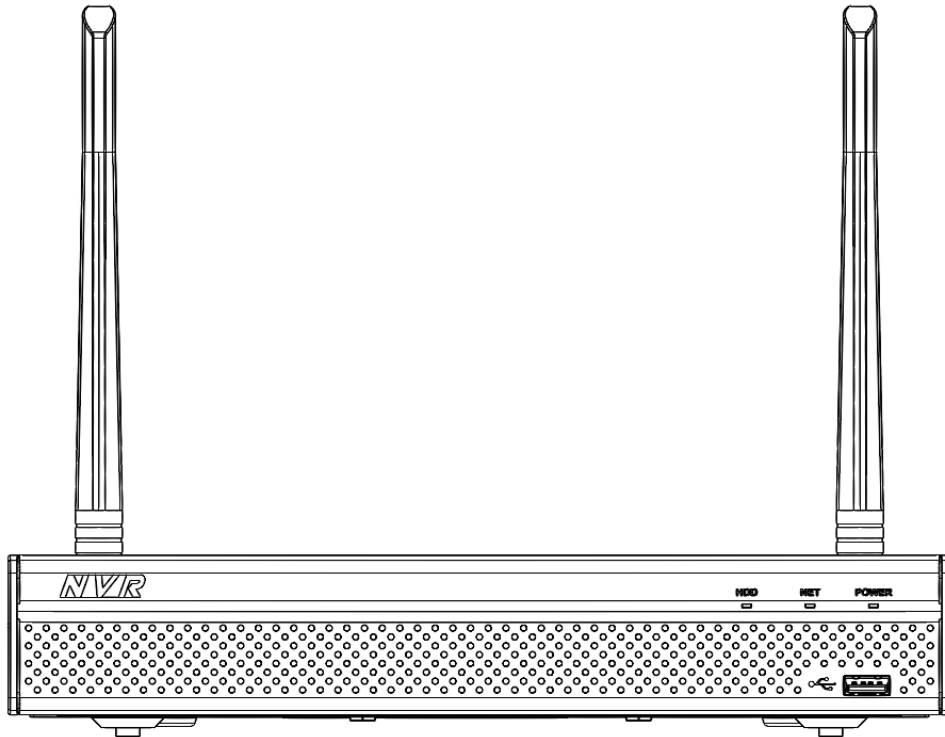



Table 2-14

Icon	Name	Function
HDD	HDD status indicator light	The blue light is on when the HDD is malfunction.
NET	Network status indicator light	The blue light is on when the network connection is abnormal.
POWER	Power status indicator light	The blue light is on when the power connection is OK.
	USB2.0 port	Connect to peripheral USB 2.0 storage device, mouse and etc.

## 2.2 Rear Panel

### 2.2.1 Beneficio Smart 1U / Beneficio Smart 1U with 1 PoE port/ Beneficio Smart 1U with 8 PoE ports/ Beneficio Smart 1U with wireless Series

The beneficio Smart 1U series NVR rear panel is shown as below. See Figure 2-19.

Figure 2-19

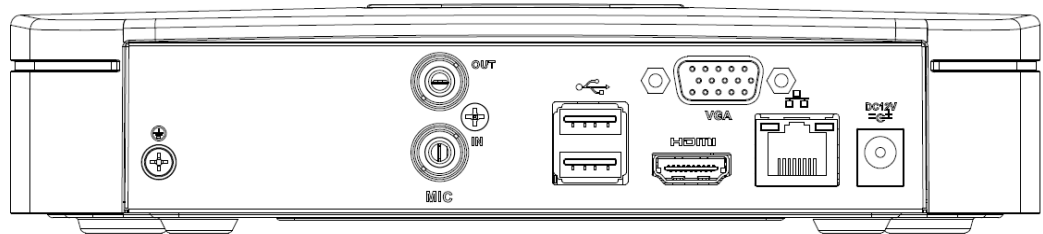

The beneficio Smart 1U with 1 PoE port series NVR rear panel is shown as below. See Figure 2-20.

Figure 2-20

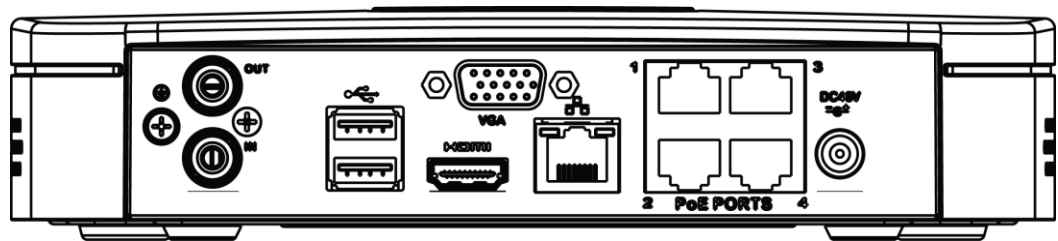

The beneficio Smart 1U with 8 PoE ports series NVR rear panel is shown as below. See Figure 2-21

Figure 2-21

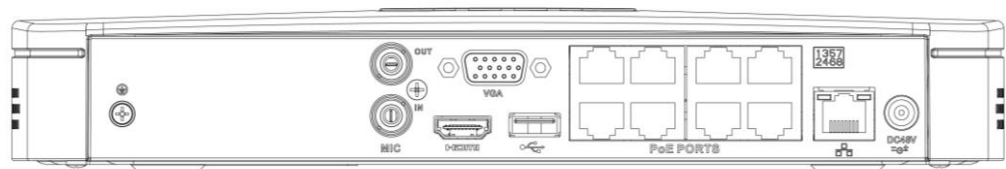

The Beneficio Smart 1U with wireless series NVR rear panel is shown as below. See Figure 2-22.

Figure 2-22

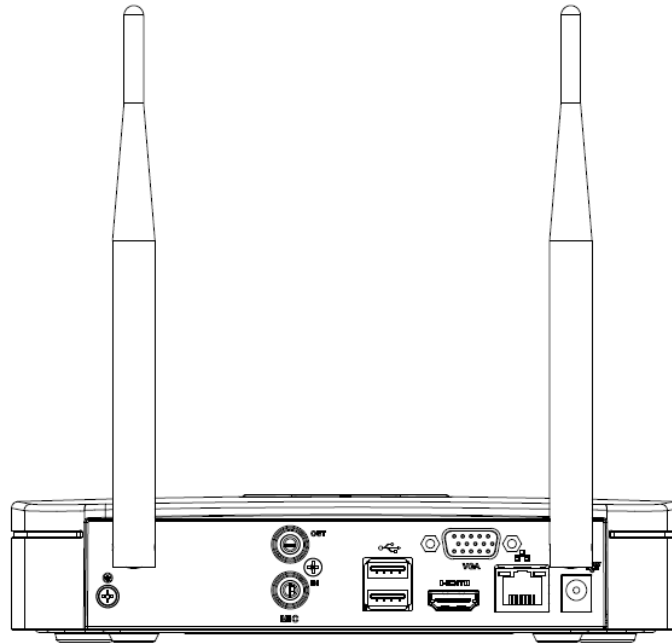



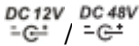

Table 2-15

Port Name	Connection	Function
	USB2.0 port	USB2.0 port. Connect to mouse, USB storage device, USB burner and etc.
	Network port	10M/100Mbps self-adaptive Ethernet port. Connect to the network cable.
HDMI	High Definition Media Interface	High definition audio and video signal output port. It transmits uncompressed high definition video and multiple-channel data to the HDMI port of the display device. HDMI version is 1.4.
VGA	VGA video output port	VGA video output port. Output analog video signal. It can connect to the monitor to view analog video.
	GND	Ground end
	Power input port	Power socket. <ul style="list-style-type: none"> <li>● For beneficio smart 1U series, input DC 12V/2A.</li> <li>● For beneficio smart 1U with 1 PoE port series, input DC 48V/1.5A.</li> <li>● For beneficio smart 1U with 8 PoE ports series, input DC 48V/2A.</li> </ul>
MIC IN	Audio input port	Bidirectional talk input port. It is to receive the analog audio signal output from the devices such as microphone, pickup.

Port Name	Connection	Function
MIC OUT	Audio output port	Audio output port. It is to output the analog audio signal to the devices such as the sound box. <ul style="list-style-type: none"> <li>● Bidirectional talk output.</li> <li>● Audio output on 1-window video monitor.</li> <li>● Audio output on 1-window video playback.</li> </ul>
PoE PORT	PoE port	Built-in switch. Support PoE function. For PoE series product, you can use this port to provide power to the network camera.
Wireless AP		Support wireless hotspot function. Use WIFI to connect to the network camera when there is a hotspot.  For Beneficio Smart 1U with wirelsss series NVR only.

## 2.2.2 Beneficio Smart 1U (S2)/ Beneficio 4K Smart 1U(S2) Series

The general series is shown as in Figure 2-23.

Figure 2-23

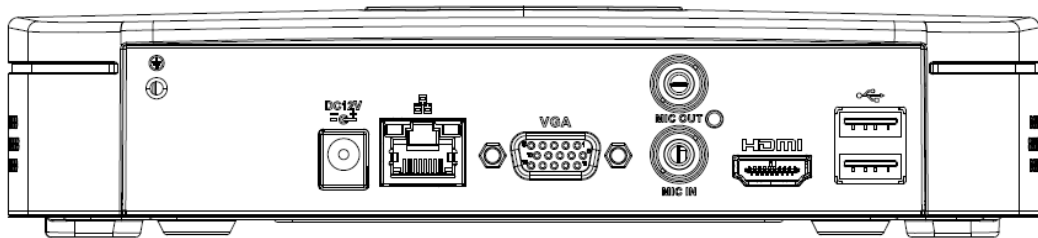

The 4 PoE ports series is shown as in Figure 2-24.

Figure 2-24

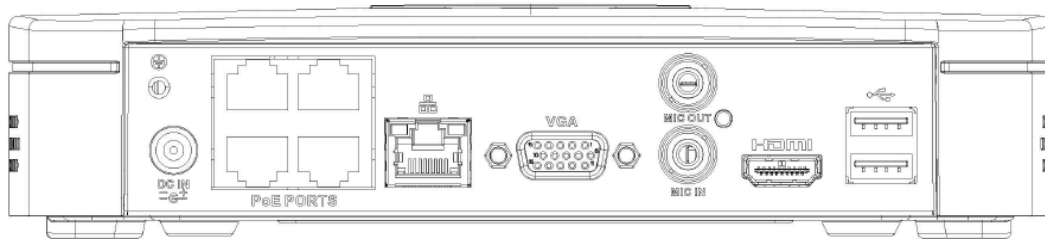

The 8 PoE ports series is shown as in Figure 2-25.

Figure 2-25

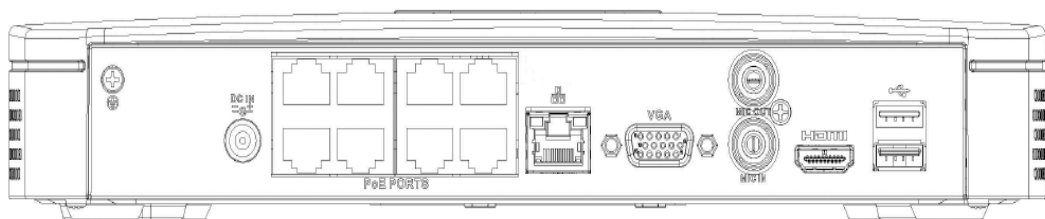







Table 2-16

Port Name	Connection	Function
	Power input port	Power socket <ul style="list-style-type: none"> <li>For general series, input DC 12V/2A.</li> <li>For 4 PoE ports series, input DC 48V/1.25A.</li> <li>For 8 PoE ports series, input DC 48V/2A.</li> </ul>
	Network port	10M/100Mbps self-adaptive Ethernet port. Connect to the network cable.
	USB port	USB port. Connect to mouse, USB storage device and etc.
HDMI	High Definition Media Interface	High definition audio and video signal output port. It transmits uncompressed high definition video and multiple-channel data to the HDMI port of the display device. HDMI version is 1.4.
VGA	VGA video output port	VGA video output port. Output analog video signal. It can connect to the monitor to view analog video.
MIC IN	Audio input port	Bidirectional talk input port. It is to receive the analog audio signal output from the devices such as microphone, pickup.
MIC OUT	Audio output port	Audio output port. It is to output the analog audio signal to the devices such as the sound box. <ul style="list-style-type: none"> <li>Bidirectional talk output.</li> <li>Audio output on 1-window video monitor.</li> <li>Audio output on 1-window video playback.</li> </ul>
	GND	Ground end
PoE PORTS	PoE port	Built-in switch. Support PoE function. For PoE series product, you can use this port to provide power to the network camera.

### 2.2.3 Beneficio Mini 1U / Beneficio Mini 1U with 1 PoE port/ Beneficio Mini 1U with 8 PoE ports Series

The beneficio mini 1U series NVR rear panel is shown as in Figure 2-26.

Figure 2-26

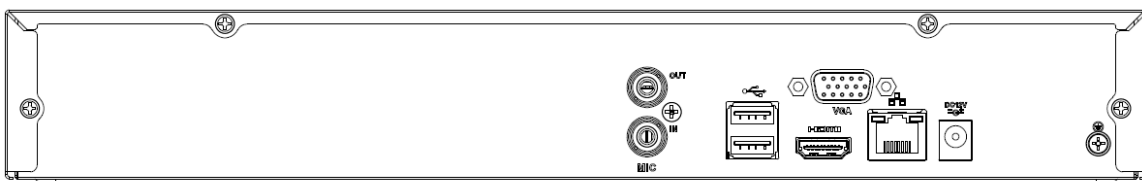

The beneficio mini 1U with 1 PoE port series NVR rear panel is shown as in Figure 2-27.

Figure 2-27

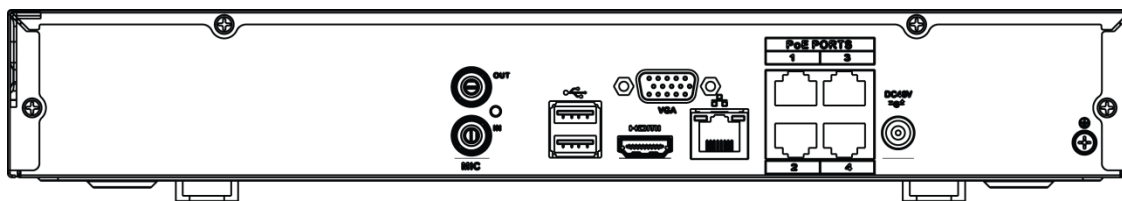

The beneficio mini 1U with 8 PoE ports series NVR rear panel is shown as in Figure 2-28.

Figure 2-28

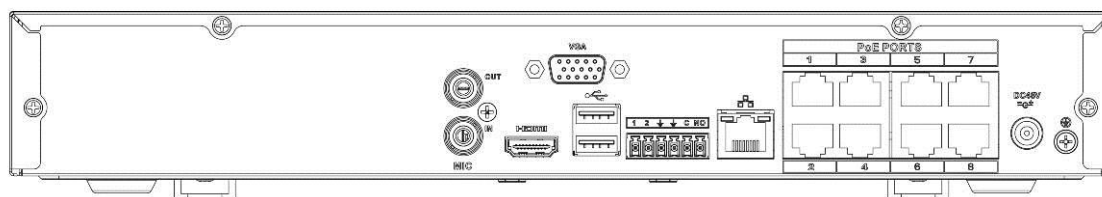



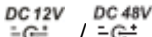

Table 2-17

Port Name	Connection	Function
	USB2.0 port	USB2.0 port. Connect to mouse, USB storage device, USB burner and etc.
	Network port	10M/100Mbps self-adaptive Ethernet port. Connect to the network cable.
HDMI	High Definition Media Interface	High definition audio and video signal output port. It transmits uncompressed high definition video and multiple-channel data to the HDMI port of the display device. HDMI version is 1.4.
VGA	VGA video output port	VGA video output port. Output analog video signal. It can connect to the monitor to view analog video.
	GND	Ground end
	Power input port	Power socket. <ul style="list-style-type: none"> <li>● For beneficio mini 1U series NVR, input DC 12V/2A.</li> <li>● For beneficio mini 1U with 1 PoE port series NVR, input DC 48V/1.5A.</li> <li>● For beneficio Mini 1U with 8 PoE ports series NVR, input DC 48V/2A.</li> </ul>
MIC IN	Audio input port	Bidirectional talk input port. It is to receive the analog audio signal output from the devices such as microphone, pickup.

Port Name	Connection	Function
MIC OUT	Audio output port	Audio output port. It is to output the analog audio signal to the devices such as the sound box. <ul style="list-style-type: none"> <li>● Bidirectional talk output.</li> <li>● Audio output on 1-window video monitor.</li> <li>● Audio output on 1-window video playback.</li> </ul>
PoE PORT	PoE port	Built-in switch. Support PoE function. For PoE series product, you can use this port to provide power to the network camera.

### 2.2.4 Compact 1U (S2) / Compact 1U 4K (S2) Series

The general series rear panel is shown as below. See Figure 2-29.

Figure 2-29

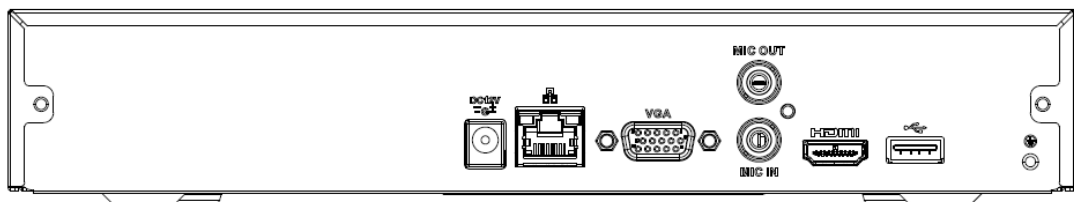

The 4 PoE ports series rear panel is shown as below. See Figure 2-30.

Figure 2-30

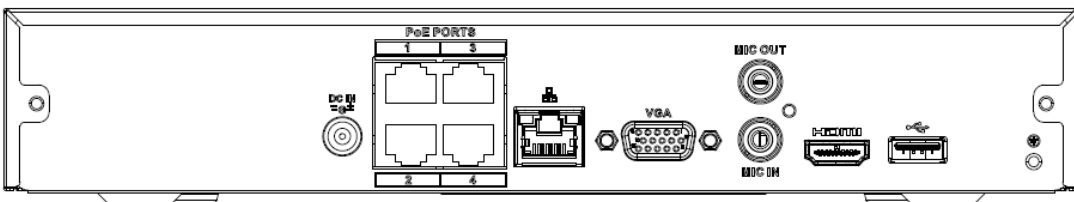

The 8 PoE ports series rear panel is shown as below. See Figure 2-31.

Figure 2-31

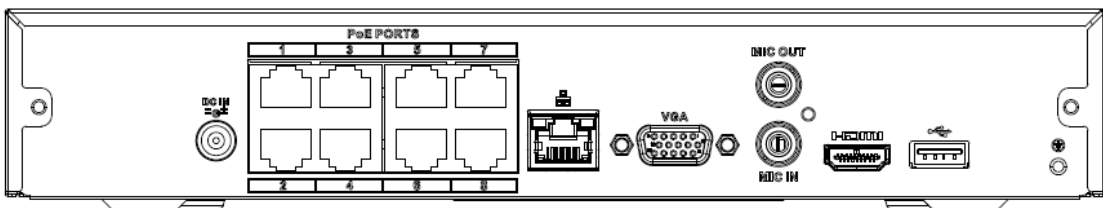



Table 2-18

Port Name	Connection	Function
DC 12V	Power input port	Power socket. <ul style="list-style-type: none"> <li>● For general series, input DC 12V/2A.</li> <li>● For 4 PoE ports series, input DC 48V/1.25A.</li> <li>● For 8 PoE ports series, input DC 48V/2A.</li> </ul>
	Network port	10M/100Mbps self-adaptive Ethernet port. Connect to the network cable.
	USB port	USB port. Connect to mouse, USB storage device and etc.

Port Name	Connection	Function
HDMI	High Definition Media Interface	High definition audio and video signal output port. It transmits uncompressed high definition video and multiple-channel data to the HDMI port of the display device. HDMI version is 1.4.
VGA	VGA video output port	VGA video output port. Output analog video signal. It can connect to the monitor to view analog video.
MIC IN	Audio input port	Bidirectional talk input port. It is to receive the analog audio signal output from the devices such as microphone, pickup.
MIC OUT	Audio output port	Audio output port. It is to output the analog audio signal to the devices such as the sound box. <ul style="list-style-type: none"> <li>● Bidirectional talk output.</li> <li>● Audio output on 1-window video monitor.</li> <li>● Audio output on 1-window video playback.</li> </ul>
	GND	Ground end
PoE PORTS	PoE port	Built-in switch. Support PoE function. For PoE series product, you can use this port to provide power to the network camera.

## 2.2.5 Compact 1U Wireless Series

The rear panel is shown as below. See Figure 2-32.

Figure 2-32

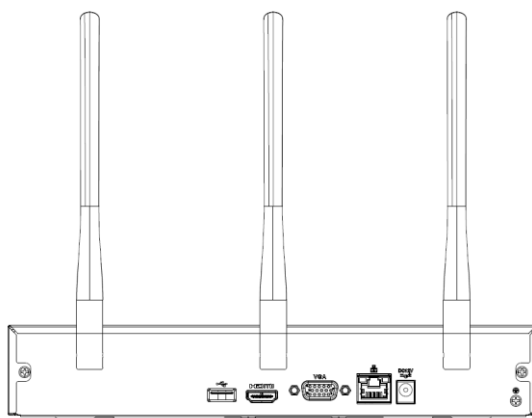





Table 2-19

Icon	Name	Function
	Power input socket.	Power socket. Input DC12V/2A.
	Network port	10M/100Mbps self-adaptive Ethernet port. Connect to the network cable.
	USB2.0 port	USB2.0 port. Connect to mouse, USB storage device, and etc.

Icon	Name	Function
HDMI	High Definition Media Interface	High definition audio and video signal output port. It transmits uncompressed high definition video and multiple-channel data to the HDMI port of the display device. HDMI version is 1.4.
VGA	VGA video output port	VGA video output port. Output analog video signal. It can connect to the monitor to view analog video.
⏏	GND	Ground end
Wireless AP	-	Support wireless hotspot function. Use WIFI to connect to the network camera when there is a hotspot.

### 2.2.6 Beneficio 1U (S2)/ Beneficio 4K 1U(S2) Series

The general series rear panel is shown as below. See Figure 2-33.

Figure 2-33

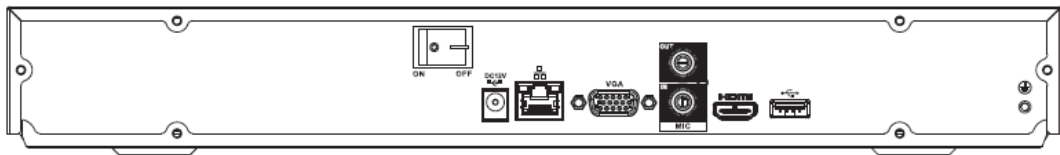

The 4 PoE ports series rear panel is shown as below. See Figure 2-34.

Figure 2-34

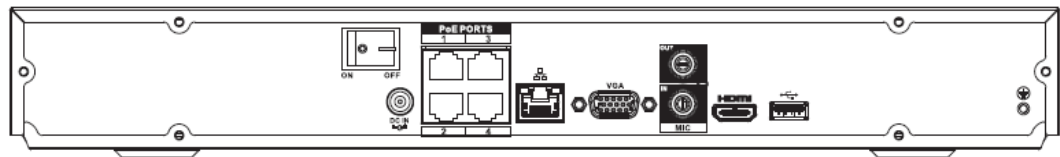

The 8 PoE ports series rear panel is shown as below. See Figure 2-35

Figure 2-35

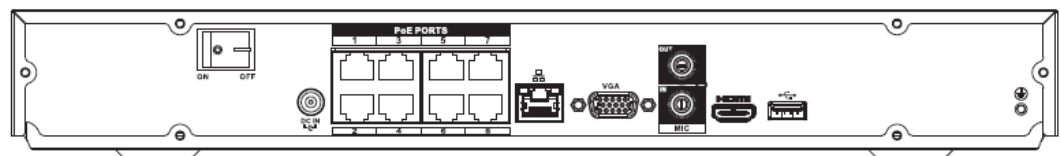





Table 2-20

Port Name	Connection	Function
	Power input port	Power socket. <ul style="list-style-type: none"> <li>For general series, input DC 12V/4A.</li> <li>For 4 PoE ports series, input DC 48V/1.5A.</li> <li>For 8 PoE ports series, input DC 53V 120W.</li> </ul>
	Network port	10M/100Mbps self-adaptive Ethernet port. Connect to the network cable.
	USB port	USB port. Connect to mouse, USB storage device and etc.
HDMI	High Definition Media Interface	High definition audio and video signal output port. It transmits uncompressed high definition video and multiple-channel data to the HDMI port of the display device. HDMI version is 1.4.
VGA	VGA video output port	VGA video output port. Output analog video signal. It can connect to the monitor to view analog video.
MIC IN	Audio input port	Bidirectional talk input port. It is to receive the analog audio signal output from the devices such as microphone, pickup.
MIC OUT	Audio output port	Audio output port. It is to output the analog audio signal to the devices such as the sound box. <ul style="list-style-type: none"> <li>Bidirectional talk output.</li> <li>Audio output on 1-window video monitor.</li> <li>Audio output on 1-window video playback.</li> </ul>
	GND	Ground end
PoE PORTS	PoE port	Built-in switch. Support PoE function. For PoE series product, you can use this port to provide power to the network camera.

### 2.2.7 Beneficio 1U / Beneficio Entry-level 1U/ Beneficio 1U with 1 PoE port/ Beneficio 1U with 8 PoE ports/ Beneficio 1U with 16 PoE Ports Series

The beneficio 1U series NVR rear panel is shown as below. See Figure 2-36.

Figure 2-36

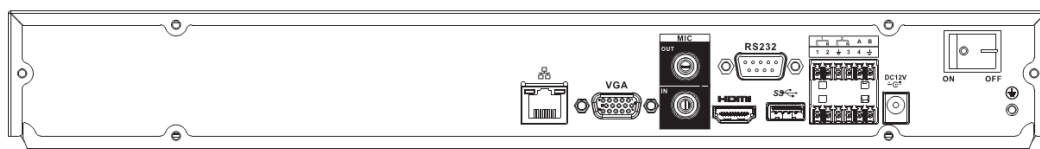

The beneficio entry-level 1U series rear panel is shown as below. See Figure 2-37.

Figure 2-37

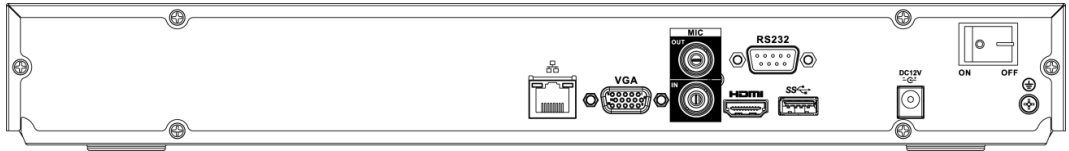

The Beneficio 1U with 1 PoE port series NVR rear panel is shown as below. See Figure 2-38.

Figure 2-38

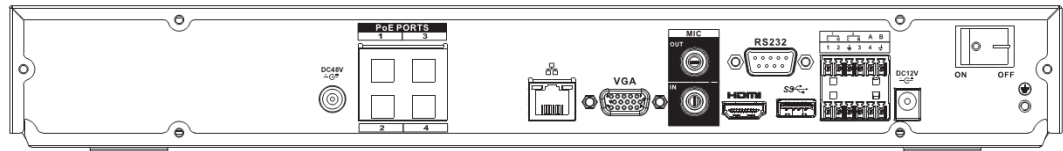

The Beneficio 1U with 8 PoE ports series NVR rear panel is shown as below. See Figure 2-39.

Figure 2-39

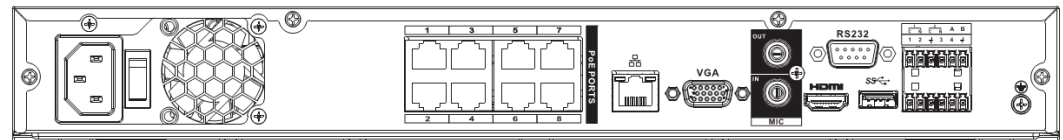

The Beneficio 1U with 16 PoE Ports series rear panel is shown as below. See Figure 2-40.

Figure 2-40

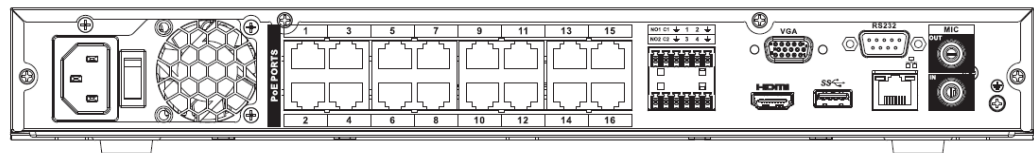
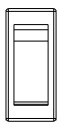









Table 2-21

Name	Function	
	Power switch	Power on/off button.
		
	Power input port	Input DC 12V/5A. For Beneficio 1U series product only.
		Switch power port. Input DC 48V/1.04A. For Beneficio 1U with 1 PoE port series product only.
		Input AC 100~240V. For Beneficio 1U with 8/16 PoE ports series product only.

Name		Function
MIC IN	Audio input port	Bidirectional talk input port. It is to receive the analog audio signal output from the devices such as microphone, pickup.
MIC OUT	Audio output port	Audio output port. It is to output the analog audio signal to the devices such as the sound box. <ul style="list-style-type: none"> <li>● Bidirectional talk output.</li> <li>● Audio output on 1-window video monitor.</li> <li>● Audio output on 1-window video playback.</li> </ul>
1~4	Alarm input port 1~4	<ul style="list-style-type: none"> <li>● There are two types; NO (normal open)/NC (normal close).</li> <li>● When your alarm input device is using external power, please make sure the device and the NVR have the same ground.</li> </ul>
	GND	Alarm input ground port.
N1, N2 C1, C2	Alarm output port 1~2	<ul style="list-style-type: none"> <li>● 2 groups of alarm output ports. (Group 1: port NO1~C1, Group 2: port NO2~C2). Output alarm signal to the alarm device. Please make sure there is power to the external alarm device.</li> <li>● NO: Normal open alarm output port.</li> <li>● C: Alarm output public end.</li> </ul>
A	RS-485 communication port	RS485_A port. It is the cable A. You can connect to the control devices such as speed dome PTZ.
B		RS485_B. It is the cable B. You can connect to the control devices such as speed dome PTZ.
	Network port	10M/100M/1000Mbps self-adaptive Ethernet port. Connect to the network cable.
	USB2.0 port	USB2.0 port. Connect to mouse, USB storage device, USB burner and etc.
RS-232	RS-232 debug COM.	It is for general COM debug to configure IP address or transfer transparent COM data.
HDMI	High Definition Media Interface	High definition audio and video signal output port. It transmits uncompressed high definition video and multiple-channel data to the HDMI port of the display device. HDMI version is 1.4.
VGA	VGA video output port	VGA video output port. Output analog video signal. It can connect to the monitor to view analog video.



Name		Function
PoE PORTS	/	Bult-in Switch. Support PoE. The 4 PoE series product supports total 48V 50W. The 8 PoE series product supports total 48V 120W. The 16 PoE series product supports total 120W. One PoE port max supports 15W.

### 2.2.8 Professional 4K 1U/ Professional 4K 1U with 8 PoE ports/ Professional 4K 1U with 16 PoE ports/4K 1U (S2) with 24 PoE Ports/4K 1U (S2E) with 8 PoE ports/4K 1U (S2E) with 16 PoE ports Series

The professional 4K 1U series rear panel is shown as below. See Figure 2-41.

Figure 2-41

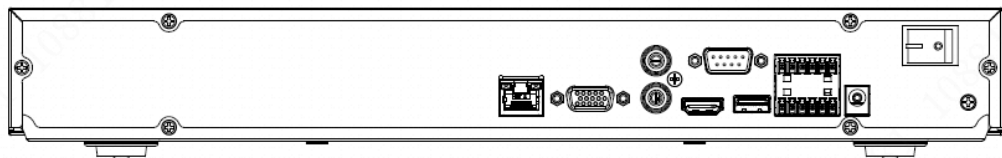

The professional 4K 1U with 8 PoE ports rear panel is shown as below. See Figure 2-42.

Figure 2-42

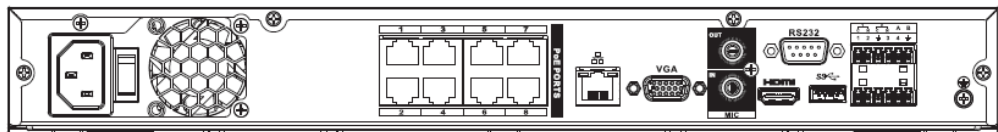

The professional 4K 1U with 16 PoE ports rear panel is shown as below. See Figure 2-43.

Figure 2-43

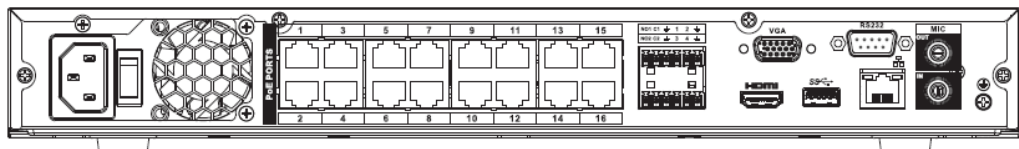

The 4K 1U (S2) with 24 PoE ports series rear panel is shown as below. See Figure 2-44.

Figure 2-44

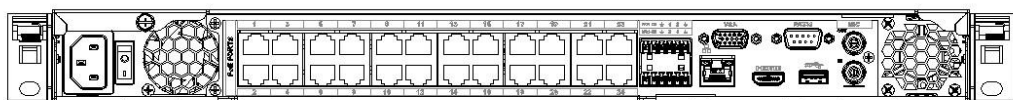

The 4K 1U (S2E) with 8 PoE ports/4K 1U (S2E) with 16 PoE ports series rear panel is shown as below. See Figure 2-45.



The following figure takes 4K 1U (S2E) with 16 PoE ports series as an example.

Figure 2-45

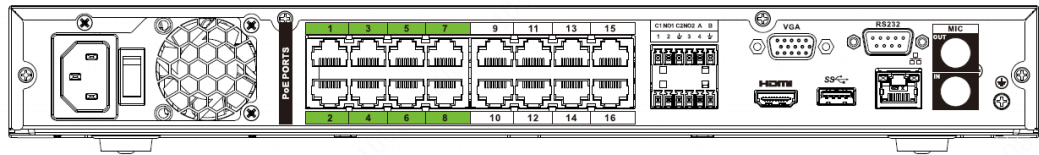













Table 2-22

Icon	Port Name	Function
	Network port	10M/100M/1000Mbps self-adaptive Ethernet port. Connect to the network cable.
	High Definition Media Interface	High definition audio and video signal output port. It transmits uncompressed high definition video and multiple-channel data to the HDMI port of the display device. HDMI version is 1.4.
	USB3.0 port	USB3.0 port. Connect to mouse, USB storage device, USB burner and etc.
	RS-232 debug COM.	It is for general COM debug to configure IP address or transfer transparent COM data.
	VGA video output port	VGA video output port. Output analog video signal. It can connect to the monitor to view analog video.
	Audio input port	Bidirectional talk input port. It is to receive the analog audio signal output from the devices such as microphone, pickup.
	Audio output port	Audio output port. It is to output the analog audio signal to the devices such as the sound box. <ul style="list-style-type: none"> <li>● Bidirectional talk output.</li> <li>● Audio output on 1-window video monitor.</li> <li>● Audio output on 1-window video playback.</li> </ul>
	Alarm input port 1~8	<ul style="list-style-type: none"> <li>● There are two groups. The first group is from port 1 to port 4; the second group is from port 5 to port 8. They are to receive the signal from the external alarm source. There are two types; NO (normal open)/NC (normal close).</li> <li>● When your alarm input device is using external power, please make sure the device and the NVR have the same ground.</li> </ul>
	GND	Alarm input ground port.
	Alarm output port	<ul style="list-style-type: none"> <li>● 3 groups of alarm output ports. (Group 1: port</li> </ul>

Icon	Port Name	Function
C1~C3	1~3	NO1 ~ C1,Group 2:port NO2 ~ C2,Group 3:port NO3~C3)).Output alarm signal to the alarm device. Please make sure there is power to the external alarm device. <ul style="list-style-type: none"> <li>● NO: Normal open alarm output port.</li> <li>● C: Alarm output public end.</li> </ul>
A	RS-485 communication port	RS485_A.It is the cable A. You can connect to the control devices such as speed dome PTZ.
B		RS485_B.It is the cable B. You can connect to the control devices such as speed dome PTZ.
	Power input port	Input DC 12V/4A.
Power switch	/	Power on/off button.
PoE PORTS	/	Built-in Switch. Support PoE or ePoE function. <ul style="list-style-type: none"> <li>● For ePoE series product, port 1 to port 8 are the ePoE ports. ePoE port supports 300 meters@100Mbps, 800 meters@10Mbps. Port 9 to port 16 are general PoE ports.</li> <li>● The 8 PoE series product supports total 130W.</li> <li>● The 16 PoE series product supports total 130W.</li> </ul>

### 2.2.9 Beneficio 1.5U / Beneficio 1.5U with 8 PoE ports/ Beneficio 1.5U with 16 PoE ports Series

The beneficio 1.5U series NVR rear panel is shown as below. See Figure 2-46.

Figure 2-46

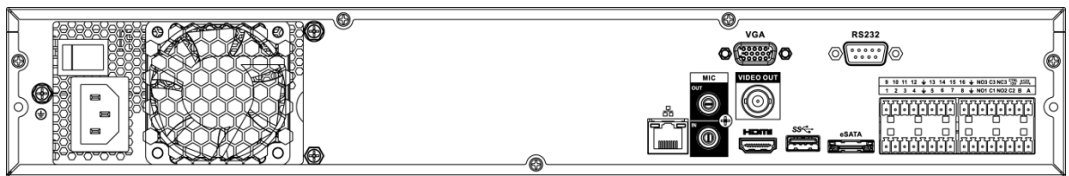

The beneficio 1.5U with eight PoE ports series NVR rear panel is shown as below. See Figure 2-47.

Figure 2-47

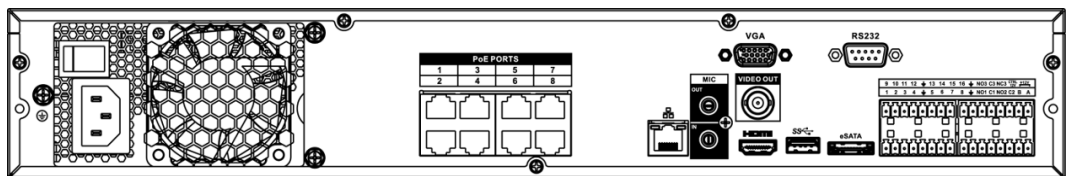

The Beneficio 1.5U with sixteen PoE ports series NVR rear panel is shown as below. See Figure 2-48.

Figure 2-48

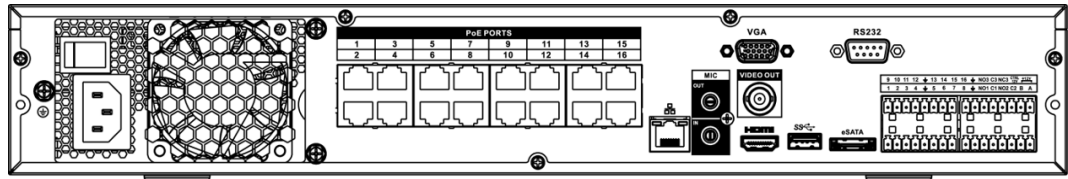



Table 2-23

Name		Function
Power switch	/	Power on-off button
Power input port	/	Input AC 100~240V.
MIC IN	Audio input port	Bidirectional talk input port. It is to receive the analog audio signal output from the devices such as microphone, pickup.
MIC OUT	Audio output port	Audio output port. It is to output the analog audio signal to the devices such as the sound box. <ul style="list-style-type: none"> <li>● Bidirectional talk output.</li> <li>● Audio output on 1-window video monitor.</li> <li>● Audio output on 1-window video playback.</li> </ul>
VIDEO OUT	Video output port	CVBS output
1~16	Alarm input port 1~16	<ul style="list-style-type: none"> <li>● There are four groups. The first group is from port 1 to port 4, the second group is from port 5 to port 8, the third group is from 9 to 12, and the fourth group is from 13 to 16. They are to receive the signal from the external alarm source. There are two types; NO (normal open)/NC (normal close).</li> <li>● When your alarm input device is using external power, please make sure the device and the NVR have the same ground.</li> </ul>
⏏	Video output port	CVBS output
NO1~NO5 C1~C5 NC5	Alarm output port 1~5	<ul style="list-style-type: none"> <li>● 5 groups of alarm output ports. (Group 1: port NO1~C1, Group 2: port NO2~C2, Group 3: port NO3~C3, Group 4: port NO4~C4, Group 5: port NO5, C5, NC5). Output alarm signal to the alarm device. Please make sure there is power to the external alarm device.</li> <li>● NO: Normal open alarm output port.</li> <li>● C: Alarm output public end.</li> <li>● NC: Normal close alarm output port.</li> </ul>
A	RS-485 communication	RS485_A port. It is the cable A. You can connect to the control devices such as speed dome PTZ.

Name		Function
B	port	RS485_B.It is the cable B. You can connect to the control devices such as speed dome PTZ.
CTRL 12V	/	Controller 12V power output. It is to control the on-off alarm relay output. It can be used to control the device alarm output. At the same time, it can also be used as the power input source of some devices such as the alarm detector.
+12V	/	+12V power output port. It can provide the power to some peripheral devices such as the camera or the alarm device. Please note the supplying power shall be below 1A.
	Network port	10M/100M/1000Mbps self-adaptive Ethernet port. Connect to the network cable.
eSATA	eSATA port	External SATA port. It can connect to the device of the SATA port. Please jump the HDD when there is peripheral connected HDD.
	USB2.0 port	USB2.0 port. Connect to mouse, USB storage device, USB burner and etc.
RS-232	RS232 debug COM.	It is for general COM debug to configure IP address or transfer transparent COM data.
HDMI	High Definition Media Interface	High definition audio and video signal output port. It transmits uncompressed high definition video and multiple-channel data to the HDMI port of the display device. HDMI version is 1.3
VGA	VGA video output port	VGA video output port. Output analog video signal. It can connect to the monitor to view analog video.
PoE PORTS	8 PoE ports	Built-in Switch. Support PoE. The 8 PoE ports series products supports total 48V 120W power. One PoE port max supports 15W.
PoE PORTS	16 PoE ports	Built-in Switch. Support PoE. The 16 PoE ports series products supports total 150W power. One PoE port max supports 15W.

**2.2.10 Professional 4K 1.5U/ Professional 4K 1.5U with 16 PoE ports/ Professional 4K 2U / Professional 4K 2U with 16 PoE ports/4K 1.5U (S2) with 24 PoE ports/4K 1.5U (S2E) with 16 PoE Ports/4K 2U (S2E) with 16 PoE ports Series**

The professional 4K 1.5U/ professional 4K 2U series rear panel is shown as below. See Figure 2-49.

Figure 2-49

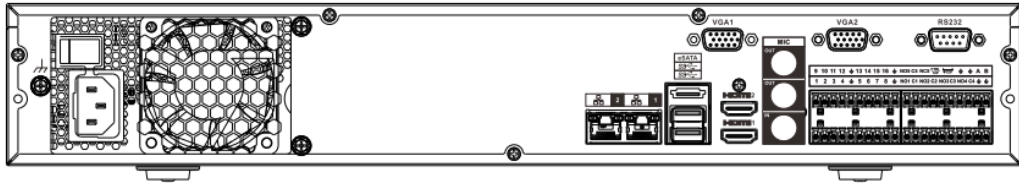

The professional 4K 1.5U with 16 PoE ports / professional 4K 2U with 16 PoE ports series rear panel is shown as below. See Figure 2-50.

Figure 2-50

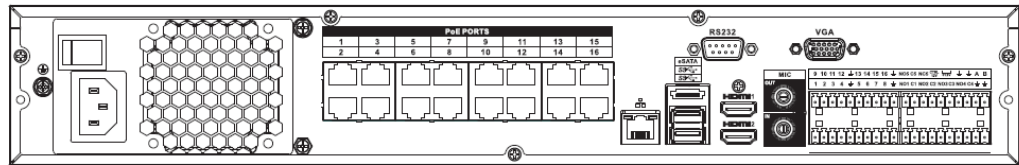

The 4K 1U (S2) with 24 PoE ports series rear panel is shown as below. See Figure 2-51.

Figure 2-51

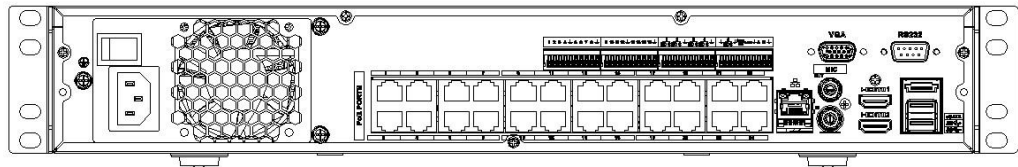

The 4K 1.5U (S2E) with 16 PoE ports series rear panel is shown as below. See Figure 2-52.

Figure 2-52

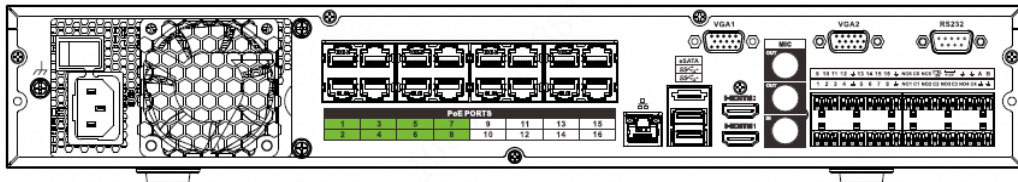

The 4K 2U (S2E) with 16 PoE ports series rear panel is shown as below. See Figure 2-53.

Figure 2-53

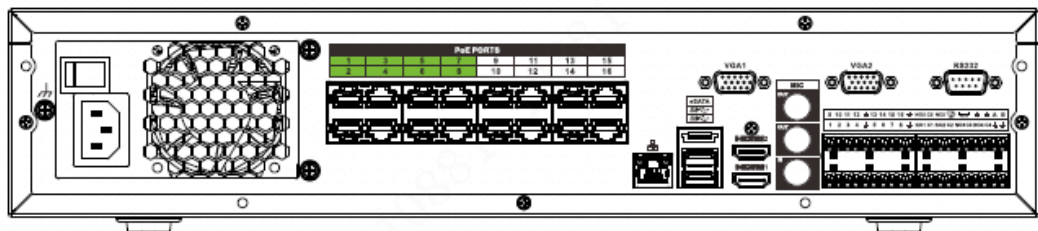







Table 2-24

Name		Function
	Power switch	Power on-off button
	Power input port	Input AC 100~240V.

Name		Function
	Network port	10M/100M/1000Mbps self-adaptive Ethernet port. Connect to the network cable.
eSATA	eSATA port	External SATA port. It can connect to the device of the SATA port. Please jump the HDD when there is peripheral connected HDD.
	USB3.0 port	USB3.0 port. Connect to mouse, USB storage device, USB burner and etc.
HDMI	High Definition Media Interface	High definition audio and video signal output port. It transmits uncompressed high definition video and multiple-channel data to the HDMI port of the display device. HDMI version is 1.4b.
MIC IN	Audio input port	Bidirectional talk input port. It is to receive the analog audio signal output from the devices such as microphone, pickup.
MIC OUT	Audio output port	Audio output port. It is to output the analog audio signal to the devices such as the sound box. <ul style="list-style-type: none"> <li>● Bidirectional talk output.</li> <li>● Audio output on 1-window video monitor.</li> <li>● Audio output on 1-window video playback.</li> </ul>
1~16	Alarm input port 1~16	<ul style="list-style-type: none"> <li>● There are four groups. The first group is from port 1 to port 4, the second group is from port 5 to port 8, the third group is from 9 to 12, and the fourth group is from 13 to 16. They are to receive the signal from the external alarm source. There are two types; NO (normal open)/NC (normal close).</li> <li>● When your alarm input device is using external power, please make sure the device and the NVR have the same ground.</li> </ul>
	Ground	Alarm input ground end.
NO1~NO5 C1~C5 NC5	Alarm output port 1~5	<ul style="list-style-type: none"> <li>● 5 groups of alarm output ports. (Group 1: port NO1~C1, Group 2: port NO2~C2, Group 3: port NO3~C3, Group 4: port NO4~C4, Group 5: port NO5, C5, NC5). Output alarm signal to the alarm device. Please make sure there is power to the external alarm device.</li> <li>● NO: Normal open alarm output port.</li> <li>● C: Alarm output public end.</li> <li>● NC: Normal close alarm output port.</li> </ul>
A	RS-485 communication port	RS485_A port. It is the cable A. You can connect to the control devices such as speed dome PTZ.
B		RS485_B. It is the cable B. You can connect to the control devices such as speed dome PTZ.

Name		Function
CTRL 12V	/	Controller 12V power output. It is to control the on-off alarm relay output. It can be used to control the device alarm output. At the same time, it can also be used as the power input source of some devices such as the alarm detector.
+12V	/	+12V power output port. It can provide the power to some peripheral devices such as the camera or the alarm device. Please note the supplying power shall be below 1A.
RS-232	RS232 debug COM.	It is for general COM debug to configure IP address or transfer transparent COM data.
VGA	VGA video output port	VGA video output port. Output analog video signal. It can connect to the monitor to view analog video.
PoE PORTS	/	<p>Built-in Switch. Support PoE or ePoE function.</p> <ul style="list-style-type: none"> <li>For ePoE series product, port 1 to port 8 are the ePoE ports. ePoE port supports 300 meters@100Mbps, 800 meters@10Mbps. Port 9 to port 16 are general PoE ports.</li> <li>The 16 PoE series product supports total 150W.</li> </ul>

### 2.2.11 4K Smart 1U (S2) Series

The general 4K smart 1U (S2) series rear panel is shown as below. See Figure 2-54.

Figure 2-54

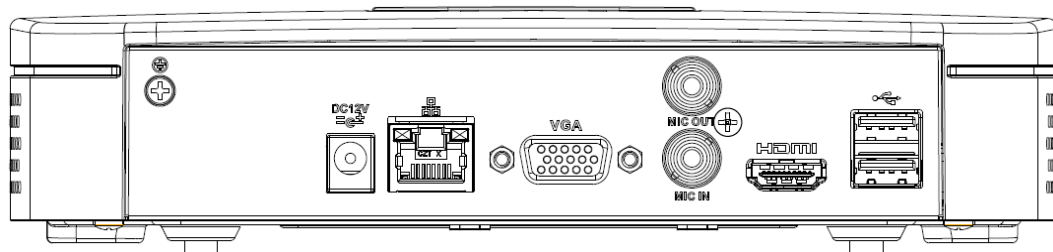

The 4K smart 1U (S2) with four PoE ports series rear panel is shown as below. See Figure 2-55.

Figure 2-55

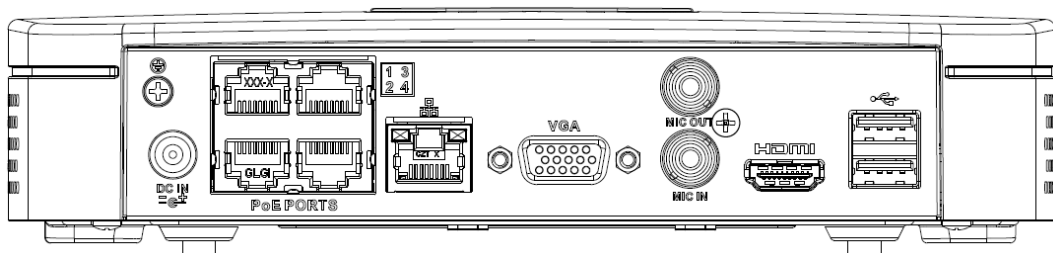

The 4K smart 1U (S2) with eight PoE ports series rear panel is shown as below. See Figure 2-56.



Figure 2-56

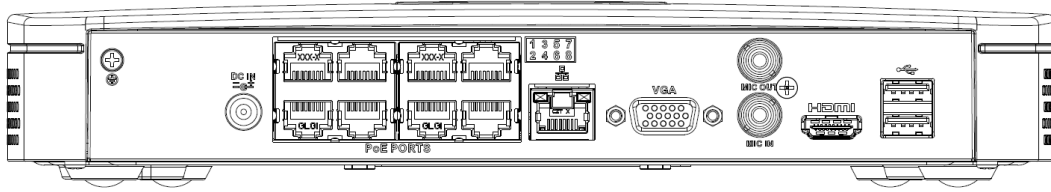



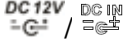

Table 2-25

Port Name	Connection	Function
	USB port	USB port. Connect to mouse, USB storage device, USB burner and etc.
	Network port	10M/100Mbps self-adaptive Ethernet port. Connect to the network cable.
HDMI	High Definition Media Interface	High definition audio and video signal output port. It transmits uncompressed high definition video and multiple-channel data to the HDMI port of the display device. HDMI version is 1.4.
VGA	VGA video output port	VGA video output port. Output analog video signal. It can connect to the monitor to view analog video.
	GND	Ground end
	Power input port	Power socket. <ul style="list-style-type: none"> <li>● For general 4K smart 1U (S2): DC 12V/2A power.</li> <li>● For 4K smart 1U (S2) with four PoE ports: DC 48V/72W power.</li> <li>● For 4K smart 1U (S2) with eight PoE ports: DC 48V/96W power.</li> </ul>
MIC IN	Audio input port	Bidirectional talk input port. It is to receive the analog audio signal output from the devices such as microphone, pickup.
MIC OUT	Audio output port	Audio output port. It is to output the analog audio signal to the devices such as the sound box. <ul style="list-style-type: none"> <li>● Bidirectional talk output.</li> <li>● Audio output on 1-window video monitor.</li> <li>● Audio output on 1-window video playback.</li> </ul>
PoE PORT	PoE port	Built-in switch. Support PoE function. For PoE series product, you can use this port to provide power to the network camera.

**2.2.12 Beneficio Vertical 1U Series**

The interface is shown as in Figure 2-57.

Figure 2-57

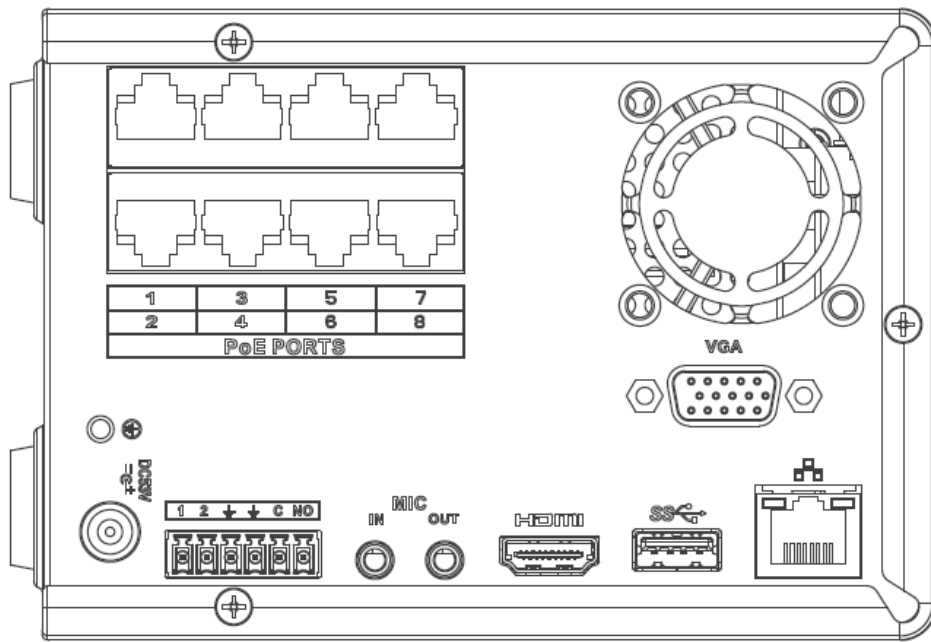





Table 2-26

Name		Function
Power switch	/	Power on/off button.
	Power input port	Input DC 53V--2.3A
MIC IN	Audio input port	Bidirectional talk input port. It is to receive the analog audio signal output from the devices such as microphone, pickup.
MIC OUT	Audio output port	Audio output port. It is to output the analog audio signal to the devices such as the sound box. <ul style="list-style-type: none"> <li>● Bidirectional talk output.</li> <li>● Audio output on 1-window video monitor.</li> <li>● Audio output on 1-window video playback.</li> </ul>
1~2	Alarm input port 1~2	<ul style="list-style-type: none"> <li>● When your alarm input device is using external power, please make sure the device and the NVR have the same ground.</li> </ul>
	GND	Alarm input ground port.
C	Alarm output public port	Alarm output public end.
NO	Normal open	Normal open alarm output port.
	Network port	10M/100M/1000Mbps self-adaptive Ethernet port. Connect to the network cable.

Name		Function
	USB3.0 port	USB3.0 port. Connect to mouse, USB storage device, USB burner and etc.
HDMI	High Definition Media Interface	High definition audio and video signal output port. It transmits uncompressed high definition video and multiple-channel data to the HDMI port of the display device. HDMI version is 1.4.
VGA	VGA video output port	VGA video output port. Output analog video signal. It can connect to the monitor to view analog video.
PoE PORT	/	Bult-in Switch. Support PoE. The 8 PoE series product supports total 48V 120W. One PoE port max supports 15W.

### 2.2.13 4K Compact 1U (S2) Series

The general 4K compact 1U (S2) series rear panel is shown as below. See Figure 2-58.

Figure 2-58

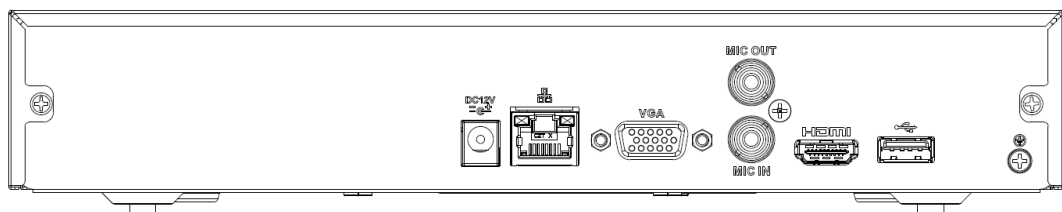

The 4K compact 1U (S2) with four PoE ports series rear panel is shown as below. See Figure 2-59.

Figure 2-59

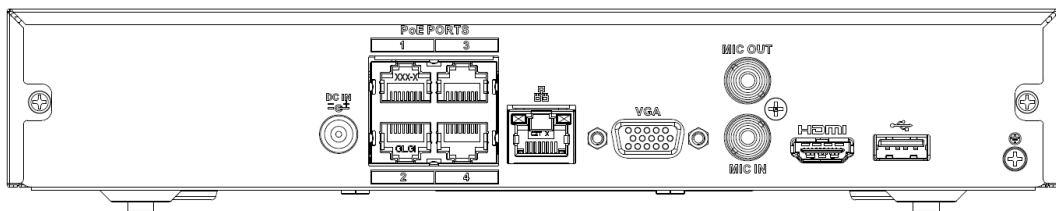

The 4K compact 1U (S2) with eight PoE ports series rear panel is shown as below. See Figure 2-60.

Figure 2-60

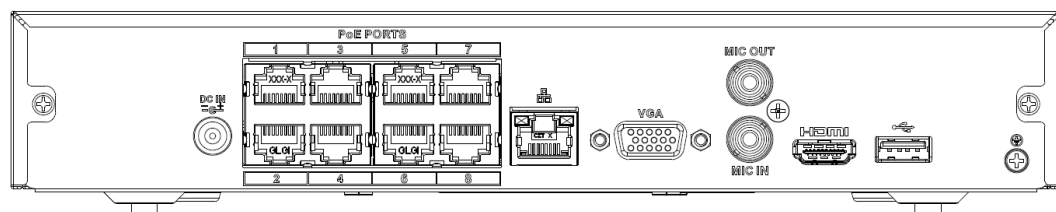

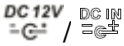





Table 2-27

Port Name	Connection	Function
	USB port	USB port. Connect to mouse, USB storage device, USB burner and etc.
	Power input port	Power socket. <ul style="list-style-type: none"> <li>● For general 4K compact 1U (S2): DC 12V/2A power.</li> <li>● For 4K compact 1U (S2) with four PoE ports: DC 48V/72W power.</li> <li>● For 4K compact 1U (S2) with eight PoE ports: DC 48V/96W power.</li> </ul>
	Network port	10M/100Mbps self-adaptive Ethernet port. Connect to the network cable.
	USB port	USB port. Connect to mouse, USB storage device and etc.
HDMI	High Definition Media Interface	High definition audio and video signal output port. It transmits uncompressed high definition video and multiple-channel data to the HDMI port of the display device. HDMI version is 1.4.
VGA	VGA video output port	VGA video output port. Output analog video signal. It can connect to the monitor to view analog video.
MIC IN	Audio input port	Bidirectional talk input port. It is to receive the analog audio signal output from the devices such as microphone, pickup.
MIC OUT	Audio output port	Audio output port. It is to output the analog audio signal to the devices such as the sound box. <ul style="list-style-type: none"> <li>● Bidirectional talk output.</li> <li>● Audio output on 1-window video monitor.</li> <li>● Audio output on 1-window video playback.</li> </ul>
	GND	Ground end
PoE PORTS	PoE port	Built-in switch. Support PoE function. For PoE series product, you can use this port to provide power to the network camera.

### 2.2.14 4K 1U (S2) Series

The general 4K 1U (S2) series rear panel is shown as below. See Figure 2-61.

Figure 2-61

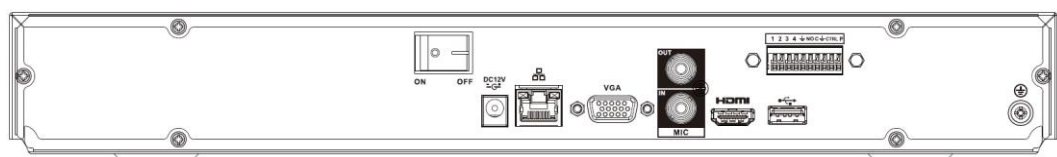

The 4K 1U (S2) with four PoE ports series rear panel is shown as below. See Figure 2-62.

Figure 2-62

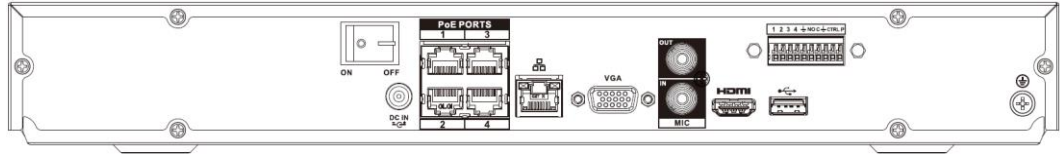

The 4K 1U (S2) with eight PoE ports series rear panel is shown as below. See Figure 2-63.

Figure 2-63

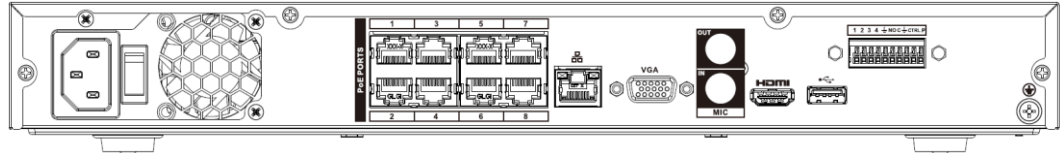

The 4K 1U (S2) with sixteen PoE ports series rear panel is shown as below. See Figure 2-64 and Figure 2-65

Figure 2-64

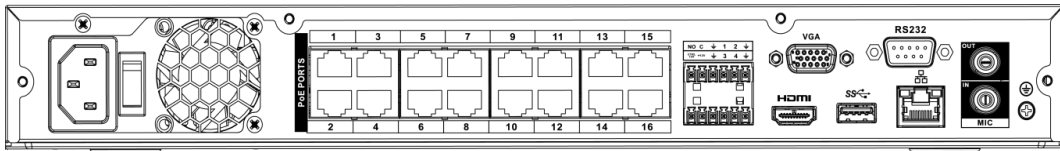

Figure 2-65

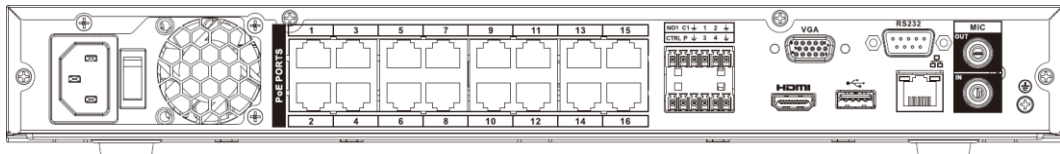
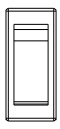







Table 2-28

Name		Function
	Power switch	Power on/off button.
	Power input port	Input DC 12V/4A. For general 4K 1U (S2) series product only.
		Switch power port. Input DC 48/96W For 4K 1U (S2) with four PoE ports series product only.
		Input AC90V~264V-12V5A/52V2.5A-190W. For 4K 1U (S2) with eight PoE ports/ 4K 1U (S2) with sixteen PoE ports series product only.
MIC IN	Audio input port	Bidirectional talk input port. It is to receive the analog audio signal output from the devices such as microphone, pickup.

Name		Function
MIC OUT	Audio output port	Audio output port. It is to output the analog audio signal to the devices such as the sound box. <ul style="list-style-type: none"> <li>● Bidirectional talk output.</li> <li>● Audio output on 1-window video monitor.</li> <li>● Audio output on 1-window video playback.</li> </ul>
1~4	Alarm input port 1~4	<ul style="list-style-type: none"> <li>● There are two types; NO (normal open)/NC (normal close).</li> <li>● When your alarm input device is using external power, please make sure the device and the NVR have the same ground.</li> </ul>
	GND	Alarm input ground port.
N1, N2 C1, C2	Alarm output port 1~2	<ul style="list-style-type: none"> <li>● 2 groups of alarm output ports. (Group 1: port NO1~C1, Group 2: port NO2~C2). Output alarm signal to the alarm device. Please make sure there is power to the external alarm device.</li> <li>● NO: Normal open alarm output port.</li> <li>● C: Alarm output public end.</li> </ul>
A	RS-485 communication port	RS485_A port. It is the cable A. You can connect to the control devices such as speed dome PTZ.
B		RS485_B. It is the cable B. You can connect to the control devices such as speed dome PTZ.
CTRL	/	Controllable power output. It is to control the on-off alarm relay output. It can be used to control the device alarm output. At the same time, it can also be used as the power input source of some devices such as the alarm detector.
P	/	Power output port. It is to offer power to external devices such as cameras and alarm devices, and the current of the device power supply should be below 1A.
	Network port	10M/100M/1000Mbps self-adaptive Ethernet port. Connect to the network cable.
	USB port	USB port. Connect to mouse, USB storage device, USB burner and etc.
RS-232	RS-232 debug COM.	It is for general COM debug to configure IP address or transfer transparent COM data.
HDMI	High Definition Media Interface	High definition audio and video signal output port. It transmits uncompressed high definition video and multiple-channel data to the HDMI port of the display device. HDMI version is 1.4.

Name		Function
VGA	VGA video output port	VGA video output port. Output analog video signal. It can connect to the monitor to view analog video.
PoE PORTS	/	Built-in Switch. Support PoE. For PoE series product, you can use this port to provide power to the network camera.

### 2.2.15 4K 1.5U (S2) Series

The general 4K 1.5U (S2) series rear panel is shown as below. See Figure 2-66.

Figure 2-66

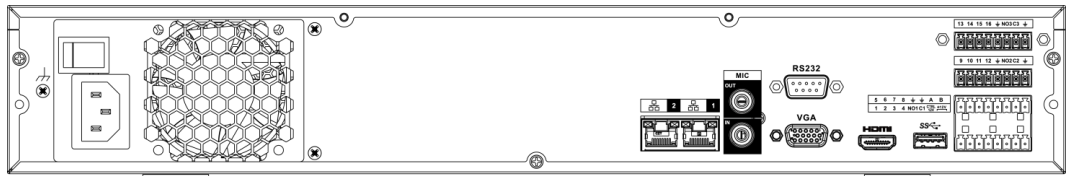

The 4K 1.5U (S2) with sixteen PoE ports series rear panel is shown as below. See Figure 2-67

Figure 2-67

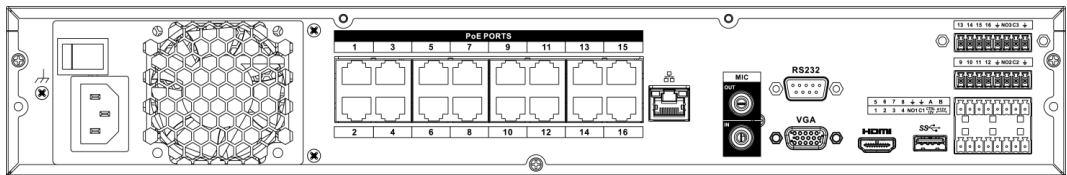





Table 2-29

Name		Function
Power switch	/	Power on-off button
Power input port	/	AC90V~264V-12V12.5A/-53V2.83A
MIC IN	Audio input port	Bidirectional talk input port. It is to receive the analog audio signal output from the devices such as microphone, pickup.
MIC OUT	Audio output port	Audio output port. It is to output the analog audio signal to the devices such as the sound box. <ul style="list-style-type: none"> <li>● Bidirectional talk output.</li> <li>● Audio output on 1-window video monitor.</li> <li>● Audio output on 1-window video playback.</li> </ul>
VIEDEO OUT	Video output port	CVBS output

Name		Function
1~16	Alarm input port 1~16	<ul style="list-style-type: none"> <li>There are four groups. The first group is from port 1 to port 4, the second group is from port 5 to port 8, the third group is from 9 to 12, and the fourth group is from 13 to 16. They are to receive the signal from the external alarm source. There are two types; NO (normal open)/NC (normal close).</li> <li>When your alarm input device is using external power, please make sure the device and the NVR have the same ground.</li> </ul>
	Video output port	CVBS output
NO1~NO5 C1~C5 NC5	Alarm output port 1~5	<ul style="list-style-type: none"> <li>5 groups of alarm output ports. (Group 1: port NO1~C1, Group 2: port NO2~C2, Group 3: port NO3~C3, Group 4: port NO4~C4, Group 5: port NO5, C5, NC5). Output alarm signal to the alarm device. Please make sure there is power to the external alarm device.</li> <li>NO: Normal open alarm output port.</li> <li>C: Alarm output public end.</li> <li>NC: Normal close alarm output port.</li> </ul>
A	RS-485 communication port	RS485_A port. It is the cable A. You can connect to the control devices such as speed dome PTZ.
B		RS485_B. It is the cable B. You can connect to the control devices such as speed dome PTZ.
CTRL 12V	/	Controller 12V power output. It is to control the on-off alarm relay output. It can be used to control the device alarm output. At the same time, it can also be used as the power input source of some devices such as the alarm detector.
+12V	/	+12V power output port. It can provide the power to some peripheral devices such as the camera or the alarm device. Please note the supplying power shall be below 1A.
	Network port	10M/100M/1000Mbps self-adaptive Ethernet port. Connect to the network cable.
eSATA	eSATA port	External SATA port. It can connect to the device of the SATA port. Please jump the HDD when there is peripheral connected HDD.
	USB2.0 port	USB2.0 port. Connect to mouse, USB storage device, USB burner and etc.
RS-232	RS232 debug COM.	It is for general COM debug to configure IP address or transfer transparent COM data.



Name		Function
HDMI	High Definition Media Interface	High definition audio and video signal output port. It transmits uncompressed high definition video and multiple-channel data to the HDMI port of the display device. HDMI version is 1.3
VGA	VGA video output port	VGA video output port. Output analog video signal. It can connect to the monitor to view analog video.
PoE PORTS	PoE port	Built-in Switch. Support PoE. For PoE series product, you can use this port to provide power to the network camera.

### 2.2.16 Beneficio 2U/Beneficio 2U with 16 PoE ports Series

The beneficio 2U series NVR rear panel is shown as below. See Figure 2-68.

Figure 2-68

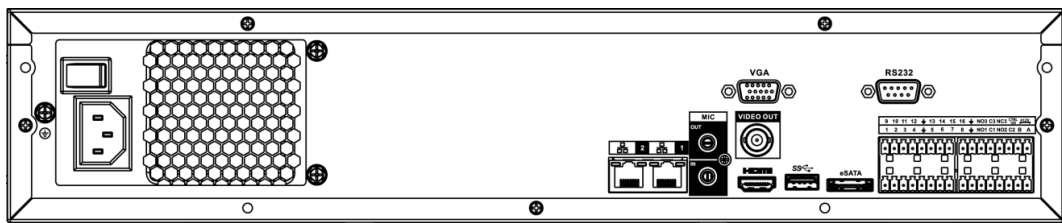

The beneficio 2U with 16 PoE ports series NVR rear panel is shown as below. See Figure 2-69.

Figure 2-69

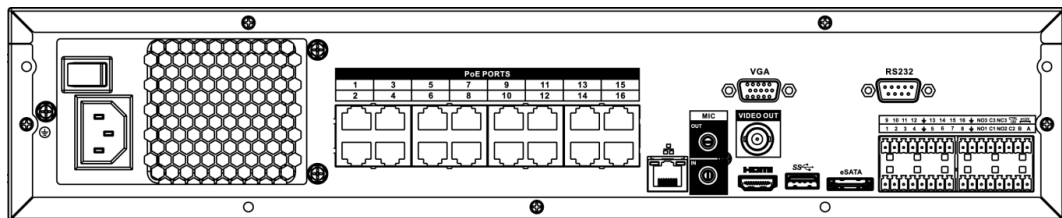





Table 2-30

Name		Function
Power switch	/	Power on-off button
Power input port	/	Input AC 100~240V.
MIC IN	Audio input port	Bidirectional talk input port. It is to receive the analog audio signal output from the devices such as microphone, pickup.
MIC OUT	Audio output port	Audio output port. It is to output the analog audio signal to the devices such as the sound box. <ul style="list-style-type: none"> <li>● Bidirectional talk output.</li> <li>● Audio output on 1-window video monitor.</li> <li>● Audio output on 1-window video playback.</li> </ul>

Name		Function
VIEDEO OUT	Video output port	CVBS output.
1~16	Alarm input port 1~16	<ul style="list-style-type: none"> <li>There are four groups. The first group is from port 1 to port 4, the second group is from port 5 to port 8, the third group is from 9 to 12, and the fourth group is from 13 to 16. They are to receive the signal from the external alarm source. There are two types; NO (normal open)/NC (normal close).</li> <li>When your alarm input device is using external power, please make sure the device and the NVR have the same ground.</li> </ul>
	GND	Alarm input ground port.
NO1~NO5 C1~C5 NC5	Alarm output port 1~5	<ul style="list-style-type: none"> <li>5 groups of alarm output ports. (Group 1: port NO1~C1, Group 2: port NO2~C2, Group 3: port NO3~C3, Group 4: port NO4~C4, Group 5: port NO5, C5, NC5). Output alarm signal to the alarm device. Please make sure there is power to the external alarm device.</li> <li>NO: Normal open alarm output port.</li> <li>C: Alarm output public end.</li> <li>NC: Normal close alarm output port.</li> </ul>
A	RS-485 communication	RS485_A port. It is the cable A. You can connect to the control devices such as speed dome PTZ.
B	port	RS485_B. It is the cable B. You can connect to the control devices such as speed dome PTZ.
CTRL 12V	/	Controller 12V power output. It is to control the on-off alarm relay output. It can be used to control the device alarm output. At the same time, it can also be used as the power input source of some devices such as the alarm detector.
+12V	/	+12V power output port. It can provide the power to some peripheral devices such as the camera or the alarm device. Please note the supplying power shall be below 1A.
	Network port	One 10M/100M/1000Mbps self-adaptive Ethernet port. Connect to the network cable.
eSATA	eSATA port	External SATA port. It can connect to the device of the SATA port. Please jump the HDD when there is peripheral connected HDD.
	USB2.0 port	USB2.0 port. Connect to mouse, USB storage device, USB burner and etc.
RS-232	RS-232 debug COM.	It is for general COM debug to configure IP address or transfer transparent COM data.

Name		Function
HDMI	High Definition Media Interface	High definition audio and video signal output port. It transmits uncompressed high definition video and multiple-channel data to the HDMI port of the display device. HDMI version is 1.3
VGA	VGA video output port	VGA video output port. Output analog video signal. It can connect to the monitor to view analog video.
PoE PORTS	16 PoE ports	Built-in Switch. Support PoE. The 16 PoE ports series products supports total 150W power. One PoE port max supports 15W.

### 2.2.17 4K 2U (S2) Series

The general 4K 2U (S2) series rear panel is shown as below. See Figure 2-70.

Figure 2-70

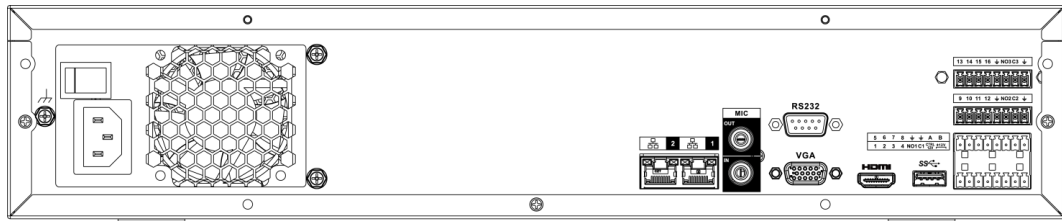

The 4K 2U (S2) with sixteen PoE ports series rear panel is shown as below. See Figure 2-71.

Figure 2-71

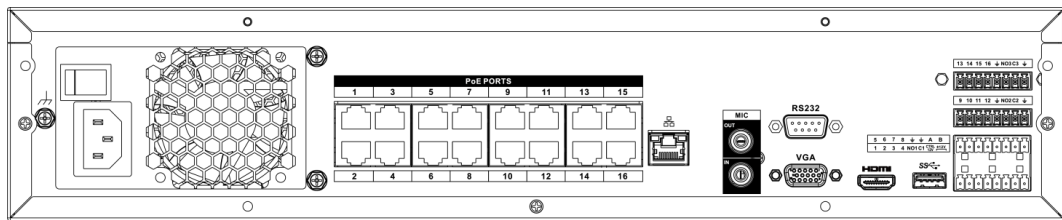





Table 2-31

Name		Function
Power switch	/	Power on-off button
Power input port	/	AC90V~264V-12V12.5A/-53V2.83A
MIC IN	Audio input port	Bidirectional talk input port. It is to receive the analog audio signal output from the devices such as microphone, pickup.

Name		Function
MIC OUT	Audio output port	Audio output port. It is to output the analog audio signal to the devices such as the sound box. <ul style="list-style-type: none"> <li>● Bidirectional talk output.</li> <li>● Audio output on 1-window video monitor.</li> <li>● Audio output on 1-window video playback.</li> </ul>
VIDEO OUT	Video output port	CVBS output.
1~16	Alarm input port 1~16	<ul style="list-style-type: none"> <li>● There are four groups. The first group is from port 1 to port 4, the second group is from port 5 to port 8, the third group is from 9 to 12, and the fourth group is from 13 to 16. They are to receive the signal from the external alarm source. There are two types; NO (normal open)/NC (normal close).</li> <li>● When your alarm input device is using external power, please make sure the device and the NVR have the same ground.</li> </ul>
	GND	Alarm input ground port.
NO1~NO5 C1~C5 NC5	Alarm output port 1~5	<ul style="list-style-type: none"> <li>● 5 groups of alarm output ports. (Group 1: port NO1~C1, Group 2: port NO2~C2, Group 3: port NO3~C3, Group 4: port NO4~C4, Group 5: port NO5, C5, NC5). Output alarm signal to the alarm device. Please make sure there is power to the external alarm device.</li> <li>● NO: Normal open alarm output port.</li> <li>● C: Alarm output public end.</li> <li>● NC: Normal close alarm output port.</li> </ul>
A	RS-485 communication port	RS485_A port. It is the cable A. You can connect to the control devices such as speed dome PTZ.
B		RS485_B. It is the cable B. You can connect to the control devices such as speed dome PTZ.
CTRL 12V	/	Controller 12V power output. It is to control the on-off alarm relay output. It can be used to control the device alarm output. At the same time, it can also be used as the power input source of some devices such as the alarm detector.
+12V	/	+12V power output port. It can provide the power to some peripheral devices such as the camera or the alarm device. Please note the supplying power shall be below 1A.
	Network port	One 10M/100M/1000Mbps self-adaptive Ethernet port. Connect to the network cable.
eSATA	eSATA port	External SATA port. It can connect to the device of the SATA port. Please jump the HDD when there is peripheral connected HDD.

Name		Function
	USB port	USB port. Connect to mouse, USB storage device, USB burner and etc.
RS-232	RS-232 debug COM.	It is for general COM debug to configure IP address or transfer transparent COM data.
HDMI	High Definition Media Interface	High definition audio and video signal output port. It transmits uncompressed high definition video and multiple-channel data to the HDMI port of the display device. HDMI version is 1.4.
VGA	VGA video output port	VGA video output port. Output analog video signal. It can connect to the monitor to view analog video.
PoE PORTS	PoE port	Built-in Switch. Support PoE. For PoE series product, you can use this port to provide power to the network camera.

### 2.2.18 Smart 1U 4K (S2) wih Wireless Series

The rear panel is shown as below. See Figure 2-72.

Figure 2-72

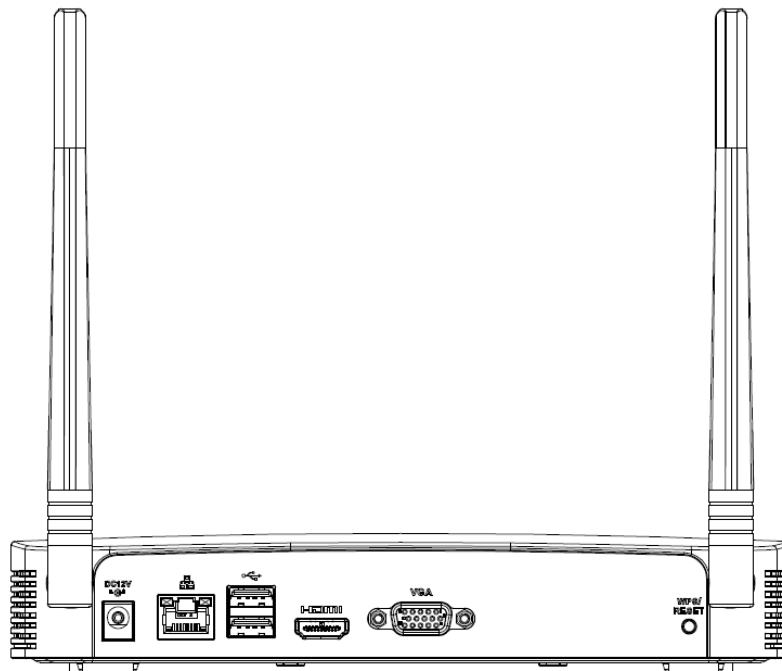





Table 2-32

Port Name	Connection	Function
	USB2.0 port	USB2.0 port. Connect to mouse, USB storage device, USB burner and etc.
	Network port	10M/100Mbps self-adaptive Ethernet port. Connect to the network cable.

Port Name	Connection	Function
HDMI	High Definition Media Interface	High definition audio and video signal output port. It transmits uncompressed high definition video and multiple-channel data to the HDMI port of the display device. HDMI version is 1.4.
VGA	VGA video output port	VGA video output port. Output analog video signal. It can connect to the monitor to view analog video.
	Power input port	Input DC 12V/2A.
WPS/RESET	Reset/WPS function	Device Wi-Fi reset and WPS function button: <ul style="list-style-type: none"> <li>● Hold down this button for 5 seconds and above to restore Wi-Fi AP to defaults.</li> <li>● Press this button for less than 2 seconds, and then press the WPS button of Wi-Fi IPC, the device and Wi-Fi IPC can be connected.</li> </ul>

### 2.2.19 Compact 1U 4K (S2) wih Wireless Series

The rear panel is shown as below. See Figure 2-73.

Figure 2-73

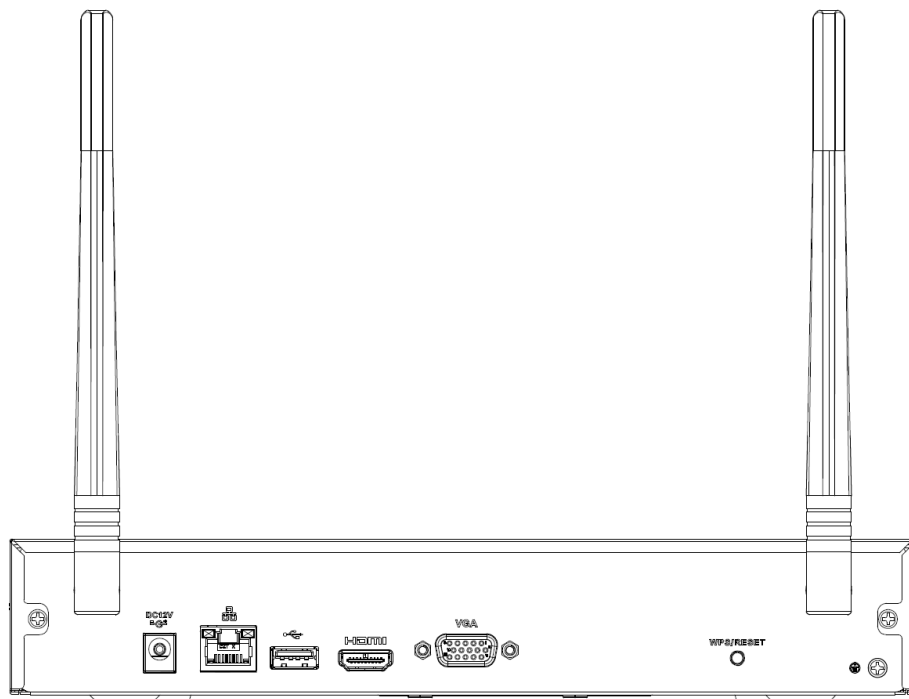





Table 2-33

Icon	Name	Function
	Power input socket.	Power socket. Input DC12V/2A.
	Network port	10M/100Mbps self-adaptive Ethernet port. Connect to the network cable.
	USB2.0 port	USB2.0 port. Connect to mouse, USB storage device, and etc.

Icon	Name	Function
HDMI	High Definition Media Interface	High definition audio and video signal output port. It transmits uncompressed high definition video and multiple-channel data to the HDMI port of the display device. HDMI version is 1.4.
VGA	VGA video output port	VGA video output port. Output analog video signal. It can connect to the monitor to view analog video.
⏏	GND	Ground end
WPS/RESET	Reset/WPS function	Device Wi-Fi reset and WPS function button: <ul style="list-style-type: none"> <li>● Hold down this button for 5 seconds and above to restore Wi-Fi AP to defaults.</li> <li>● Press this button for less than 2 seconds, and then press the WPS button of Wi-Fi IPC, the device and Wi-Fi IPC can be connected.</li> </ul>

### 2.2.20 Cooper 1U (S3) / Cooper 1U (S3) with 4 PoE Ports / Compact 1U (S3) with 8 PoE Ports Series

The Cooper 1U (S3) NVR rear panel is shown as below. See Figure 2-74.

Figure 2-74

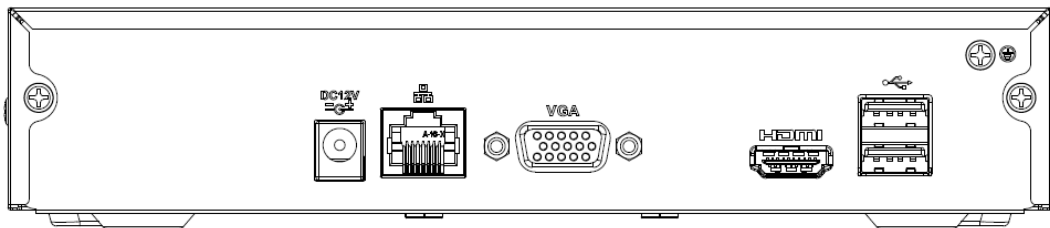

The Cooper 1U (S3) with 4 PoE Ports NVR rear panel is shown as below. See Figure 2-75.

Figure 2-75

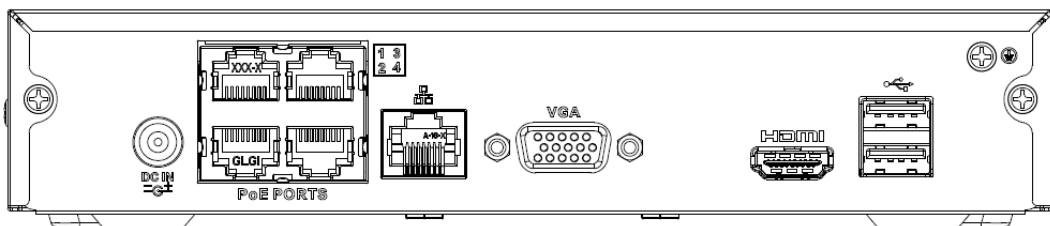

The Compact 1U (S3) with 8 PoE Ports NVR rear panel is shown as below. See Figure 2-76.

Figure 2-76

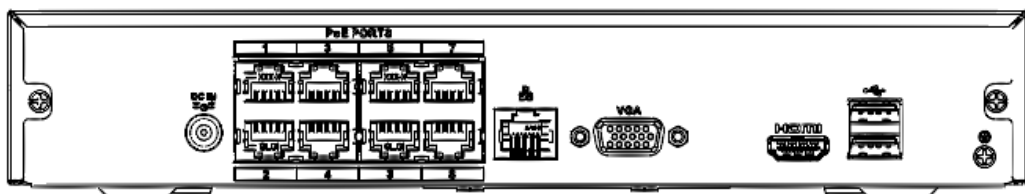





Table 2-34

Port Name	Connection	Function
DC12V	Power input port	Power socket.

Port Name	Connection	Function
PoE PORTS	PoE port	Built-in switch. Support PoE function. For PoE series product, you can use this port to provide power to the network camera.
	Network port	10M/100Mbps self-adaptive Ethernet port. Connect to the network cable.
VGA	VGA video output port	VGA video output port. Output analog video signal. It can connect to the monitor to view analog video.
MIC IN	Audio input port	Bidirectional talk input port. It is to receive the analog audio signal output from the devices such as microphone, pickup.
MIC OUT	Audio output port	Audio output port. It is to output the analog audio signal to the devices such as the sound box. <ul style="list-style-type: none"> <li>● Bidirectional talk output.</li> <li>● Audio output on 1-window video monitor.</li> <li>● Audio output on 1-window video playback.</li> </ul>
HDMI	High Definition Media Interface	High definition audio and video signal output port. It transmits uncompressed high definition video and multiple-channel data to the HDMI port of the display device.
	USB port	USB port. Connect to mouse, USB storage device and etc.
	GND	Ground end

### 2.2.21 4/8ch Compact 1U Series

The 4/8ch Compact 1U series NVR rear panel is shown as below. See Figure 2-77.

Figure 2-77

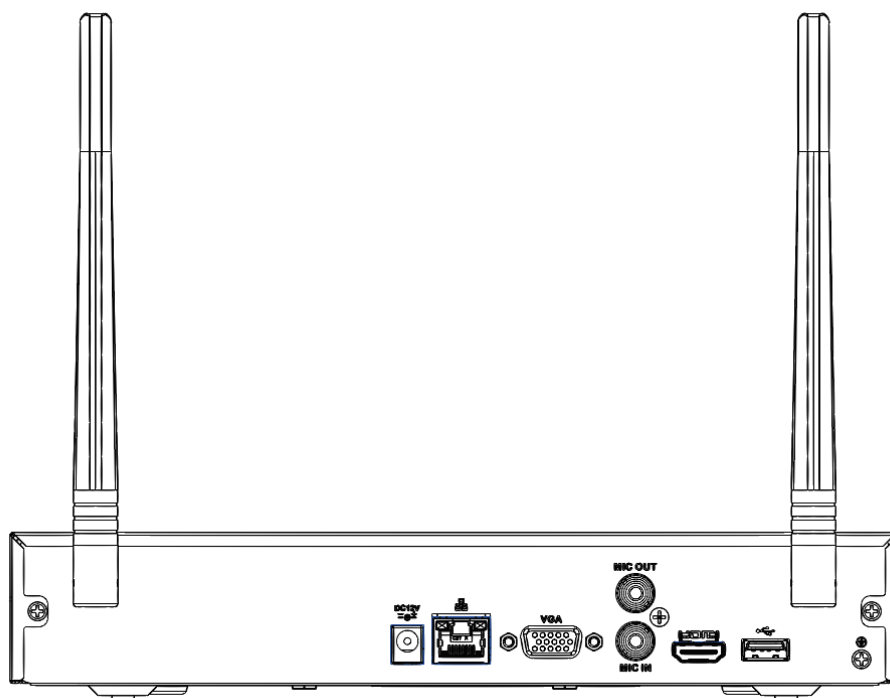







Table 2-34

Icon	Name	Function
	Power input socket.	Power socket.
MIC IN	Audio input port	Bidirectional talk input port. It is to receive the analog audio signal output from the devices such as microphone, pickup.
MIC OUT	Audio output port	Audio output port. It is to output the analog audio signal to the devices such as the sound box. <ul style="list-style-type: none"> <li>● Bidirectional talk output.</li> <li>● Audio output on 1-window video monitor.</li> <li>● Audio output on 1-window video playback.</li> </ul>
	Network port	10M/100Mbps self-adaptive Ethernet port. Connect to the network cable.
	USB2.0 port	USB2.0 port. Connect to mouse, USB storage device, and etc.
HDMI	High Definition Media Interface	High definition audio and video signal output port. It transmits uncompressed high definition video and multiple-channel data to the HDMI port of the display device. HDMI version is 1.4.
VGA	VGA video output port	VGA video output port. Output analog video signal. It can connect to the monitor to view analog video.
	GND	Ground end

## 2.3 Alarm Connection

### 2.3.1 Alarm Port

The alarm port is shown as below. See Figure 2-78. The following figure for reference only.

Figure 2-78

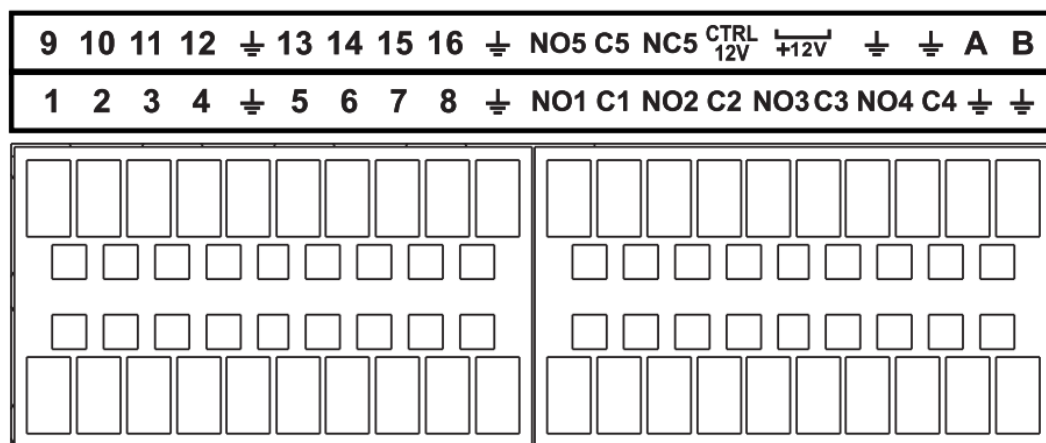



Table 2-35

Icon	Function
1~16	ALARM1~ALARM16. The alarm becomes activated in the low level.
NO1 C1, NO2 C2, NO3 C3, NO4 C4	Four NO activation output groups. (On-off button).
NO5 C5 NC5	One NO/NC activation output group. (On-off button).
CTRL 12V	Control power output. Disable power output when alarm is canceled. Current is 500mA.
+12V	Rated current output. Current is 500mA.
	GND
A/B	485 communication port. They are used to control devices such as PTZ. Please parallel connect 120TΩ between A/B cables if there are too many PTZ decoders.

#### Note

- Different models support different alarm input ports. Please refer to the specifications sheet for detailed information.
- Slight difference may be found on the alarm port layout.

### 2.3.2 Alarm input port

Connect the positive end (+) of the alarm input device to the alarm input port (ALARM IN 1~16) of the NVR. Connect the negative end (-) of the alarm input device to the ground end () of the NVR.

Figure 2-79



NOTE

- There are two alarm input types: NO/NC.
- When connect the ground port of the alarm device to the NVR, you can use any of the GND ports ().
- Connect the NC port of the alarm device to the alarm input port (ALARM) of the NVR.
- When there is peripheral power supplying for the alarm device, please make sure it is earthed with the NVR.

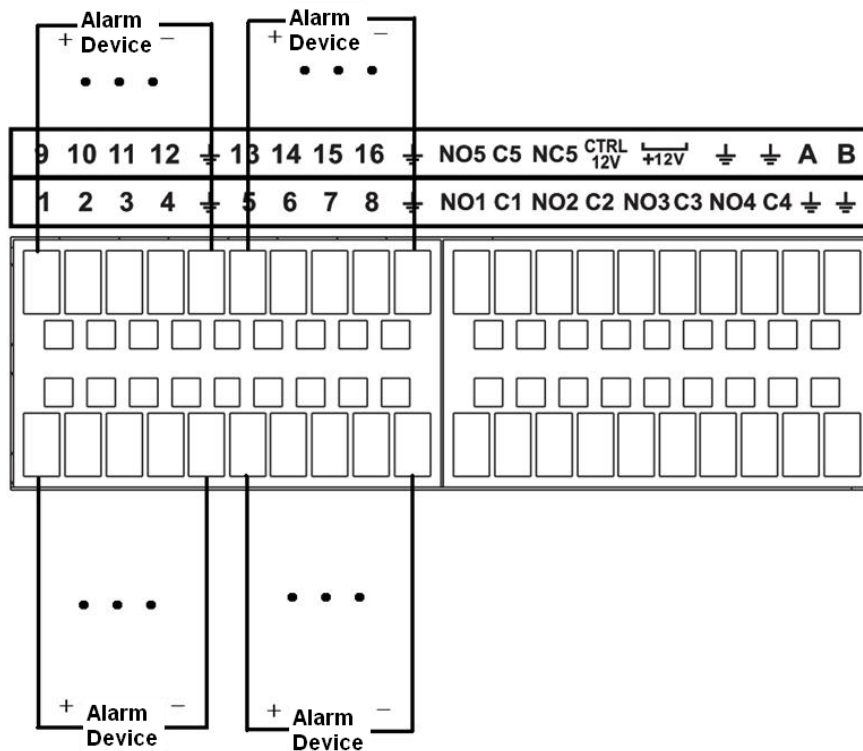
**2.3.3 Alarm input and output port**

- There is peripheral power supplying for the external alarm device.
- In case overload may result in NVR damage, please refer to the following relay specifications for detailed information.
- A/B cable of the RS485 is for the A/B cable connection of the speed PTZ.

**2.3.4 Alarm relay specifications**

Table 2-36

<b>Model:</b>	<b>JRC-27F</b>	
Material of the touch	Silver	
Rating (Resistance Load)	Rated switch capacity	30VDC 2A, 125VAC 1A
	Maximum switch power	125VA 160W
	Maximum switch voltage	250VAC, 220VDC

	Maximum switch current	1A
Insulation	Between touches with same polarity	1000VAC 1minute
	Between touches with different polarity	1000VAC 1minute
	Between touch and winding	1000VAC 1minute
Surge voltage	Between touches with same polarity	1500V (10×160us)
Length of open time	3ms max	
Length of close time	3ms max	
Longevity	Mechanical	50×10 <sup>6</sup> MIN (3Hz)
	Electrical	200×10 <sup>3</sup> MIN (0.5Hz)
Temperature	-40°C - +70°C	

## 2.4 Bidirectional talk

### 2.4.1 Device-end to PC-end

#### Device Connection

Please connect the speaker or the pickup to the first audio input port in the device rear panel. Then connect the earphone or the sound box to the audio output port in the PC.

Login the Web and then enable the corresponding channel real-time monitor.

Please refer to the following interface to enable bidirectional talk. See Figure 2-80.

Figure 2-80

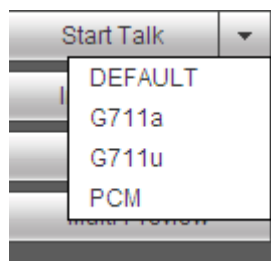

#### Listening Operation

At the device end, speak via the speaker or the pickup, and then you can get the audio from the earphone or sound box at the pc-end. See Figure 2-81.

Figure 2-81

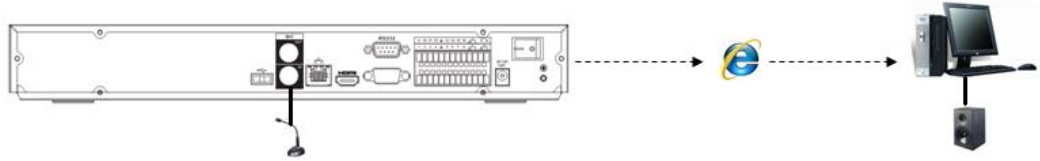

## 2.4.2 PC-end to the device-end

### Device Connection

Connect the speaker or the pickup to the audio output port in the PC and then connect the earphone or the sound box to the first audio input port in the device rear panel.

Login the Web and then enable the corresponding channel real-time monitor.

Please refer to the above interface (Figure 2-80) to enable bidirectional talk.

### Listening Operation

At the PC-end, speak via the speaker or the pickup, and then you can get the audio from the earphone or sound box at the device-end. See Figure 2-82.

Figure 2-82

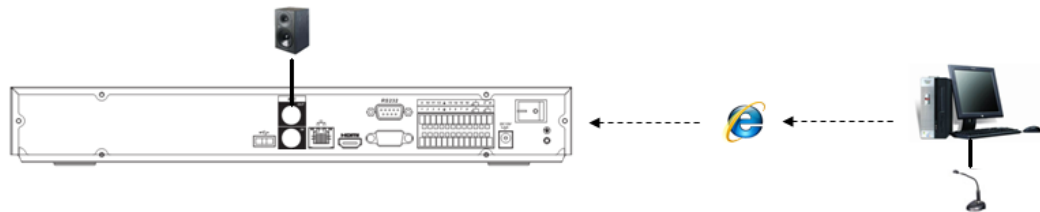

## 2.5 Mouse Operation

Table 2-37

Operation	Description
Left click mouse	When you have selected one menu item, left click mouse to view menu content.
	Modify checkbox or motion detection status.
	Click combo box to pop up dropdown list

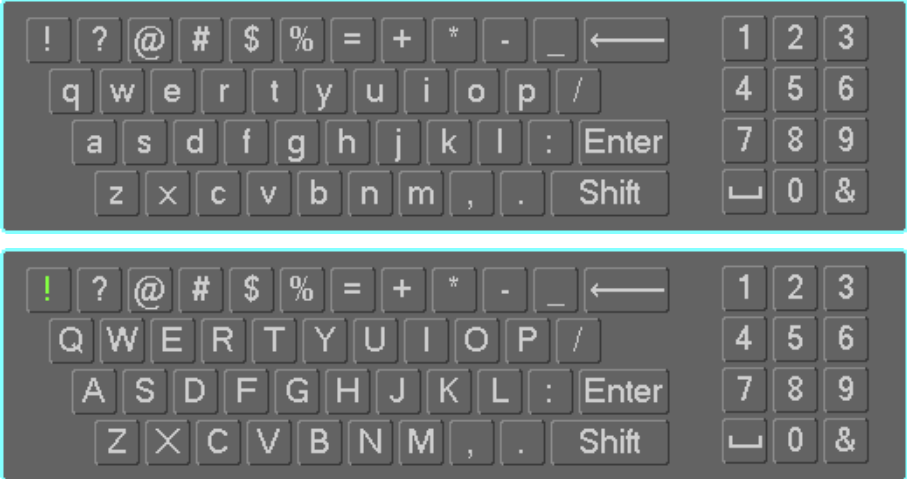
	<p>In input box, you can select input methods. Left click the corresponding button on the panel you can input numeral/English character (small/capitalized). Here ← stands for backspace button. _ stands for space button.</p> <p>In English input mode: _ stands for input a backspace icon and ← stands for deleting the previous character.</p>  <p>In numeral input mode: _ stands for clear and ← stands for deleting the previous numeral.</p>
Double left click mouse	<p>Implement special control operation such as double click one item in the file list to playback the video.</p> <p>In multiple-window mode, double left click one channel to view in full-window.</p> <p>Double left click current video again to go back to previous multiple-window mode.</p>
Right click mouse	<p>In real-time monitor mode, pops up shortcut menu.</p> <p>Exit current menu without saving the modification.</p>
Press middle button	<p>In numeral input box: Increase or decrease numeral value.</p> <p>Switch the items in the check box.</p> <p>Page up or page down</p>
Move mouse	Select current control or move control
Drag mouse	<p>Select motion detection zone</p> <p>Select privacy mask zone.</p>

## 2.6 Remote Control

The remote control interface is shown as in Figure 2-83.

Please note remote control is not our standard accessory and it is not included in the accessory bag.

Figure 2-83

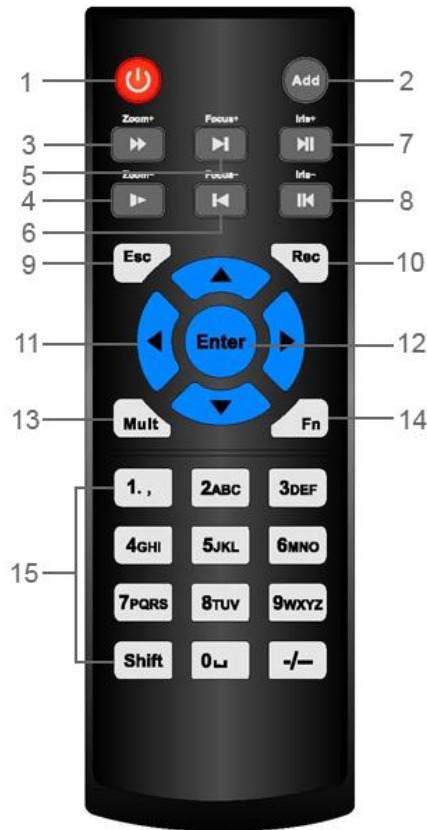

Table 2-38

No.	Name	Function
1	Power button	Press this button to boot up or shut down the device.
2	Address	Press this button to input device serial number, so that you can control the Device.
3	Forward	Multi-step forward speed and normal speed playback.
4	Slow motion	Multi-step slow motion speed or normal playback.
5	Next record	In playback state, press this button to play back the next video.
6	Previous record	In playback state, press this button to play back the previous video.
7	Play/Pause	<ul style="list-style-type: none"> <li>• In normal playback state, press this button to pause playback.</li> <li>• In pause state, press this button to resume to normal playback.</li> <li>• In live view window interface, press this button to enter video search menu.</li> </ul>
8	Reverse/pause	<p>In the reverse playback state, press this button to pause reverse playback.</p> <p>In the reverse playback pause state, press this button to resume to playback reversing state.</p>
9	Esc.	Go back to previous menu or cancel current operation (close front interface or control).

No.	Name	Function
10	Record	<ul style="list-style-type: none"> <li>Start or stop record manually.</li> <li>In record interface, use the direction buttons to select the channel that you want to record.</li> <li>Press this button for at least 1.5 seconds, and the manual record interface will be displayed.</li> </ul>
11	Direction keys	Switch between current activated controls by going left or right. In playback state, the keys control the playback progress bar. Aux function (such as operating the PTZ menu).
12	Enter/menu key	<ul style="list-style-type: none"> <li>Confirms an operation.</li> <li>Go to the <b>OK</b> button.</li> <li>Go to the menu.</li> </ul>
13	Multiple-window switch	Switch between multiple-window and one-window.
14	Fn	<ul style="list-style-type: none"> <li>In single-channel monitoring mode, press this button to display the PTZ control and color setting functions.</li> <li>Switch the PTZ control menu in PTZ control interface.</li> <li>In motion detection interface, press this button with direction keys to complete setup.</li> <li>In text mode, press and hold this button to delete the last character. To use the clearing function: Long press this button for 1.5 seconds.</li> <li>In HDD menu, switch HDD recording time and other information as indicated in the pop-up message.</li> </ul>
15	Alphanumeric keys	<ul style="list-style-type: none"> <li>Input password, numbers.</li> <li>Switch channel.</li> <li>Press Shift to switch the input method.</li> </ul>



## 3 Device Installation

**Note:** All the installation and operations here should conform to your local electric safety rules.

### 3.1 Device Installation Diagrams

Please refer to the following diagrams to install the NVR.

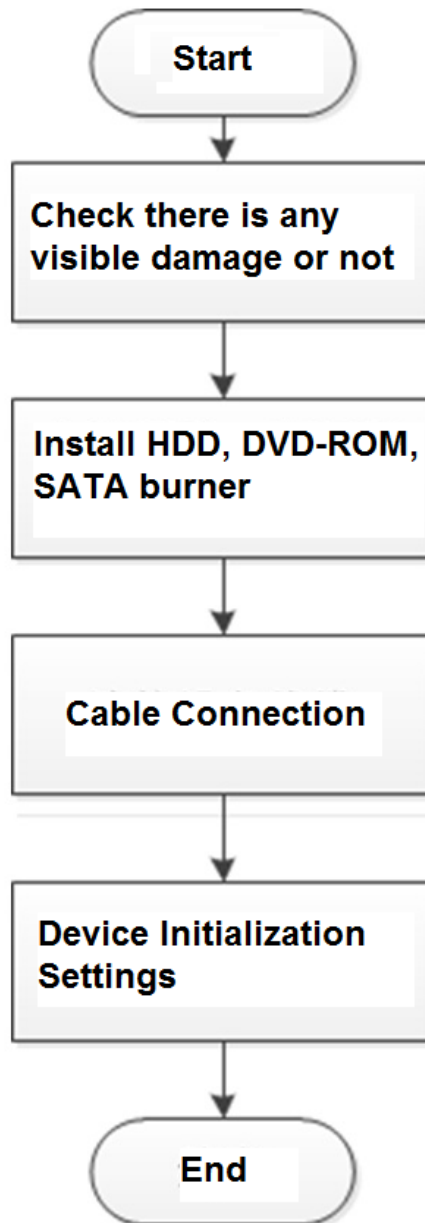

### 3.2 Check Unpacked NVR

When you receive the NVR from the forwarding agent, please check whether there is any visible damage. The protective materials used for the package of the NVR can protect most accidental clashes during transportation. Then you can open the box to check the accessories.

Please check the items in accordance with the list. Finally you can remove the protective film of the NVR.

### 3.3 About Front Panel and Rear Panel

The model number in the stick on the bottom of NVR is very important; please check according to your purchase order.

The label in the rear panel is very important too. Usually we need you to represent the serial number

when we provide the service after sales.

### 3.4 HDD Installation

For the first time installation, make sure whether the HDD has been installed or not. We recommend to use HDD of enterprise level or surveillance level. It is not recommended to use PC HDD.



**CAUTION**

- Shut off the power before you replace the HDD.
- Use the dedicated SATA HDD for monitoring recommended by the HDD manufacturer.
- You can refer to the Appendix for HDD space information and recommended HDD brand.

#### 3.4.1 Smart 1U Series

##### Note

Connect cable and then secure the HDD on the NVR if it is not convenient to connect the HDD data cable and power cable at first.



①. Loosen the screws of the bottom of the chassis.



② Place the HDD in accordance with the four holes in the bottom.



③ Turn the device upside down and then secure the screws firmly.



④ Connect the HDD cable and power cable to the HDD and the mainboard respectively.



⑤ Put the cover back and then fix the screws of the rear panel. The installation is complete.

#### 3.4.2 Mini 1U/Cooper 1U/Compact 1U Series



①. Loosen the screws of the upper cover and side panel.



② Connect the one end of the HDD data cable and the power cable to the mainboard.



③ Connect the other end of the HDD data cable and the power cable to the HDD.

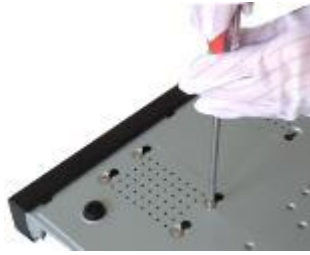

④ Place the HDD in accordance with the four holes on the bottom of the chassis.

⑤ Turn the device upside down; fix the screws to secure the HDD on the bottom of the chassis.

⑥ Put the cover in accordance with the clip and then fix the screws on the rear panel and side panel.

### 3.4.3 1U Series

The following figures are based on the professional 1U with 8 PoE ports series.

#### Note

Connect cable and then secure the HDD on the NVR if it is not convenient to connect the HDD data cable and power cable at first.



① Loosen the screws of the rear panel and side panel.

② Place the HDD in accordance with the four holes in the bottom.

③ Turn the device upside down and then secure the screws firmly. It is to fix the HDD on the chassis.



④ Connect the HDD cable and power cable.

⑤ Put the cover in accordance with the clip and then fix the screws on the rear panel and side panel.

### 3.4.4 1.5U Series



① Use the screwdriver to loose the screws of the rear panel and then remove the front cover.

② Put the HDD to the HDD bracket in the chassis and then line up the four screws to the four holes

in the HDD. Use the screwdriver to fix the screws firmly to secure HDD on the HDD bracket



- ③ Connect to the HDD data cable to the main board and the HDD port respectively. Loosen the power cable of the chassis and connect another end of the power cable to the HDD port.



- ④ After connect the cable, put the front cover back to the device and then fix screws of the rear panel.

### 3.4.5 General 2U Series



- ① Use the screwdriver to loose the screws of the rear panel and then remove the front cover.



- ② Put the HDD to the HDD bracket in the chassis and then line up the four screws to the four holes in the HDD. Use the screwdriver to fix the screws firmly to secure HDD on the HDD bracket



- ③ Connect to the HDD data cable to the main board and the HDD port respectively. Loosen the power cable of the chassis and connect another end of the power cable to the HDD port.



- ④ After connect the cable, put the front cover back to the device and then fix screws of the rear panel.

### 3.4.6 Beneficio Vertical 1U Series

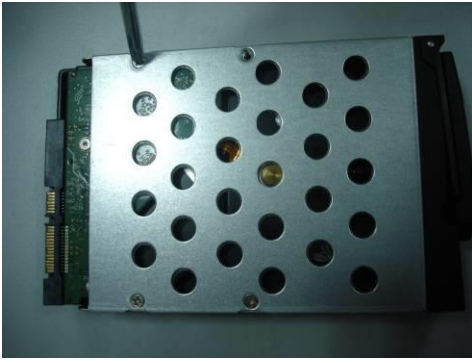

① Use 4 screws to secure the HDD



② Put the HDD to the HDD box at the front.



③ Pull the HDD knob up when you put the HDD into the box in case the knob buckle may strike the front panel.



④ Put the knob back after you insert the HDD to the SATA board.

### 3.5 CD-ROM Installation

Please follow the steps listed below.



① Open top cover and then remove the HDD bracket



② Take off the bottom of the HDD bracket and CD-ROM bracket.



③ Fix the CD-ROM bracket at the HDD bracket.



④ Install a pair of the CD-ROM bracket. Please make sure the reverse side is secure too.



⑤ Install SATA burner. Line up the SATA burner to the hole positions.



⑥ User screwdriver to fix the screws.



⑦ Put the bracket back. Please adjust the CD-ROM to the proper position so that the button of the front panel is directly facing the pop-up button of the CD-ROM.

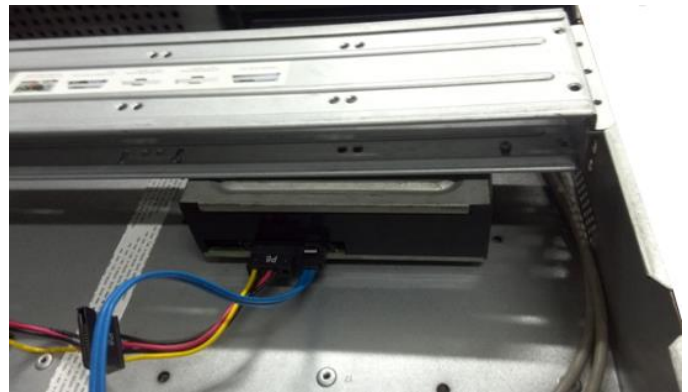

⑧ Connect the SATA cable and power wire.



⑨ Secure the HDD bracket and put the top cover back.

### 3.6 Connection Sample

#### 3.6.1 Beneficio Smart 1U/Beneficio Smart 1U(S2)/ 4K Smart 1U (S2) Series

Please refer to Figure 3-1 for connection sample.

The following figure for reference only.

Figure 3-1

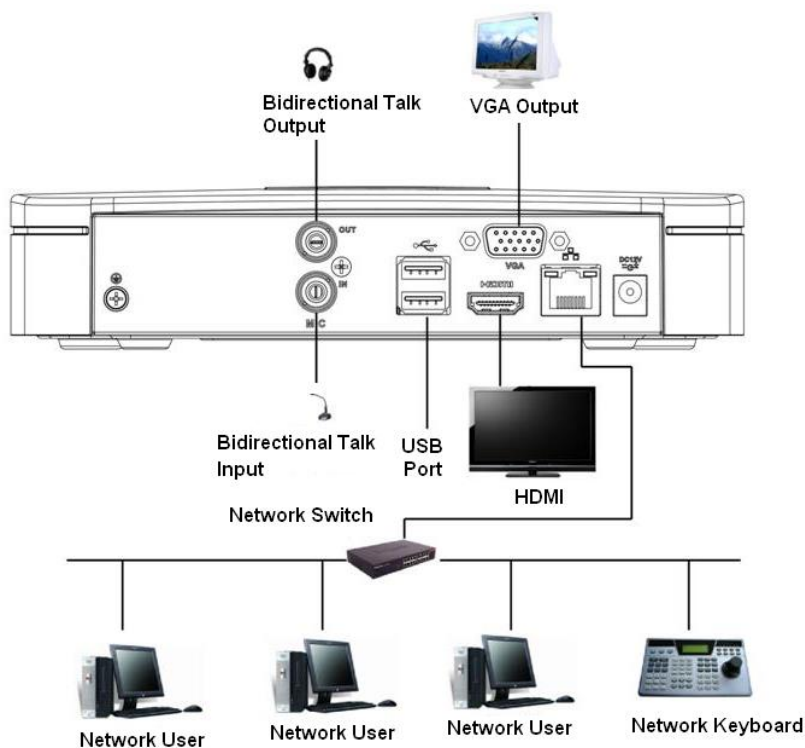

#### 3.6.2 Beneficio Mini 1U / Beneficio Mini 1U with 4 PoE Ports / Beneficio mini 1U with 8 PoE Ports Series

Please refer to Figure 3-2 for connection sample.

The following figure for reference only.

Figure 3-2

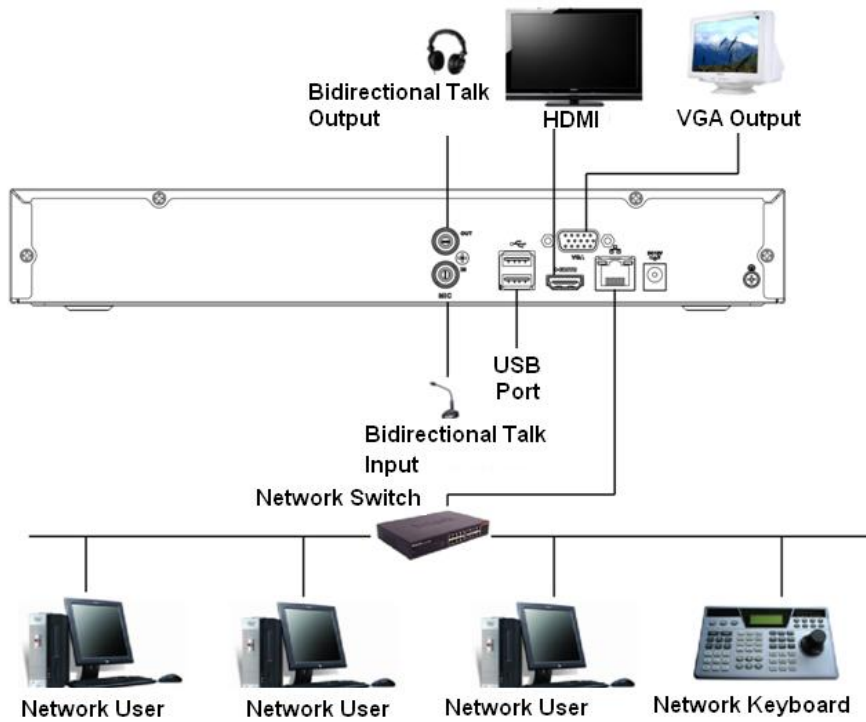

### 3.6.3 Smart 1U / Compact 1U Wireless Series

Please refer to Figure 3-3 for connection sample.  
The following figure for reference only.

Figure 3-3

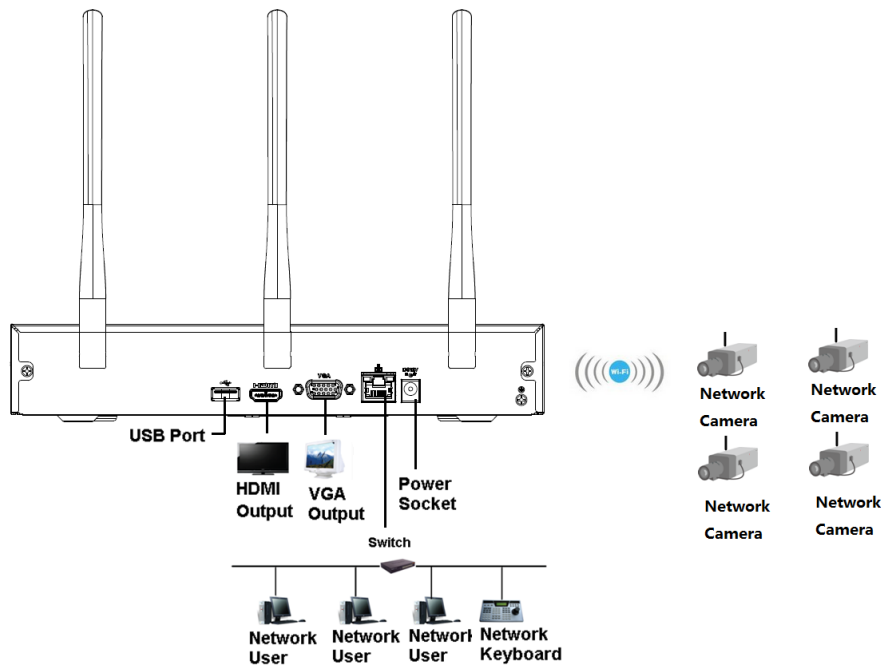

### 3.6.4 Compact 1U (S2) /4K Compact 1U (S2) / Cooper 1U (S3) / Cooper 1U (S3) with 4 PoE Ports / Compact 1U (S3) with 8 PoE Ports Series

Please refer to Figure 3-4 for connection sample.  
The following figure for reference only.



Figure 3-4

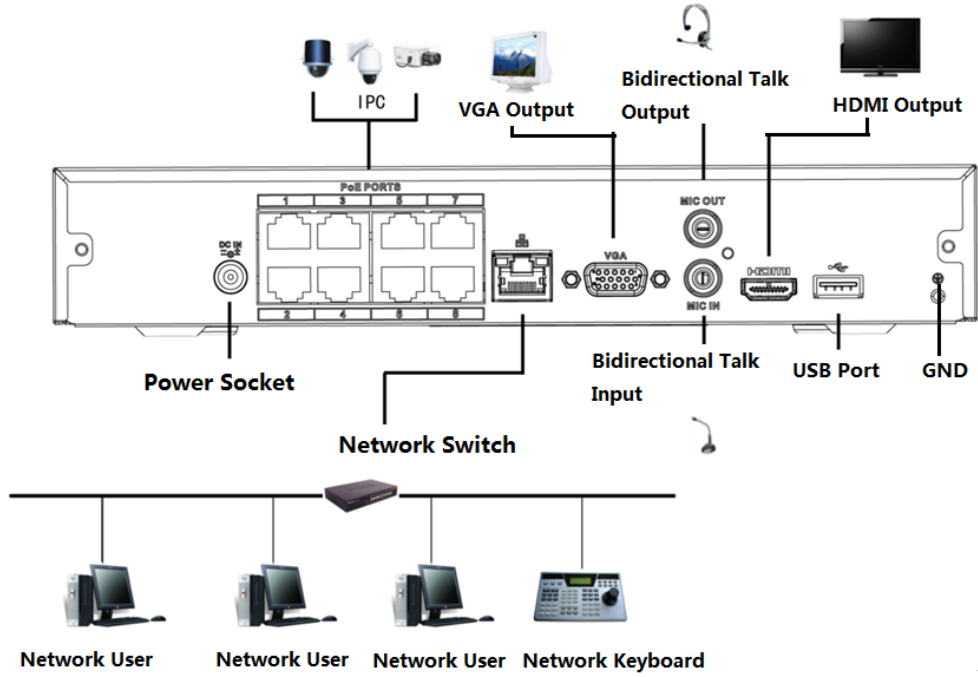

### 3.6.5 Beneficio 1U (S2) Series

Please refer to Figure 3-5 for connection sample.  
The following figure for reference only.

Figure 3-5

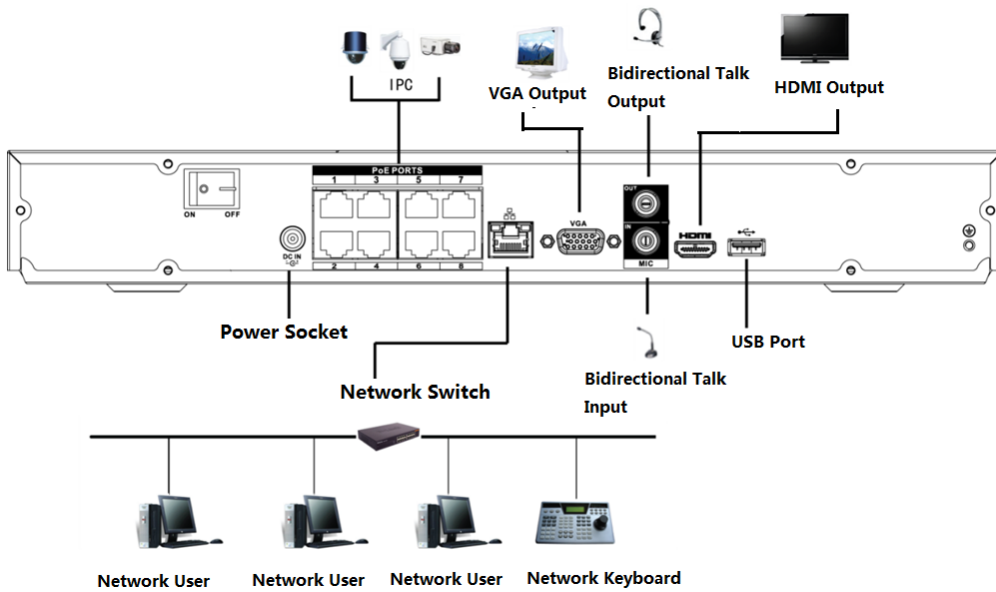

### 3.6.6 Beneficio Entry-level 1U Series

Please refer to Figure 3-6 for connection sample.

Figure 3-6

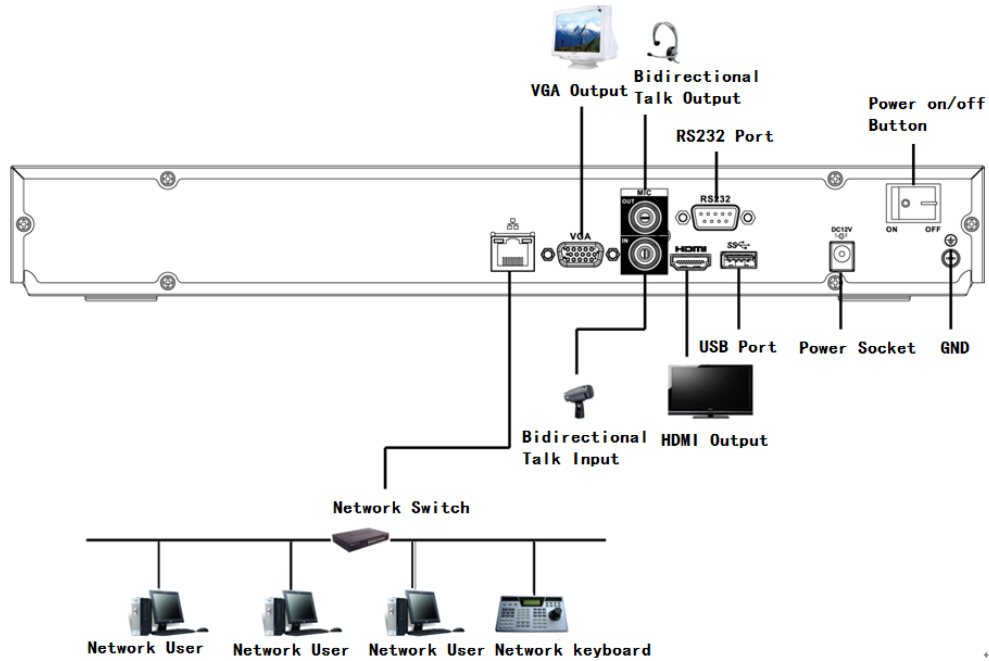

**3.6.7 Beneficio 1U/Professional 4K 1U/ Professional 4K 1U with 8 PoE ports/  
Professional 4K 1U with 16 PoE ports/4K 1U (S2) with 24 PoE Ports/4K 1U (S2E)  
with 8 PoE Ports/4K 1U (S2E) with 16 PoE Ports Series**

Please refer to Figure 3-7 for connection sample.  
The following figure for reference only.

Figure 3-7

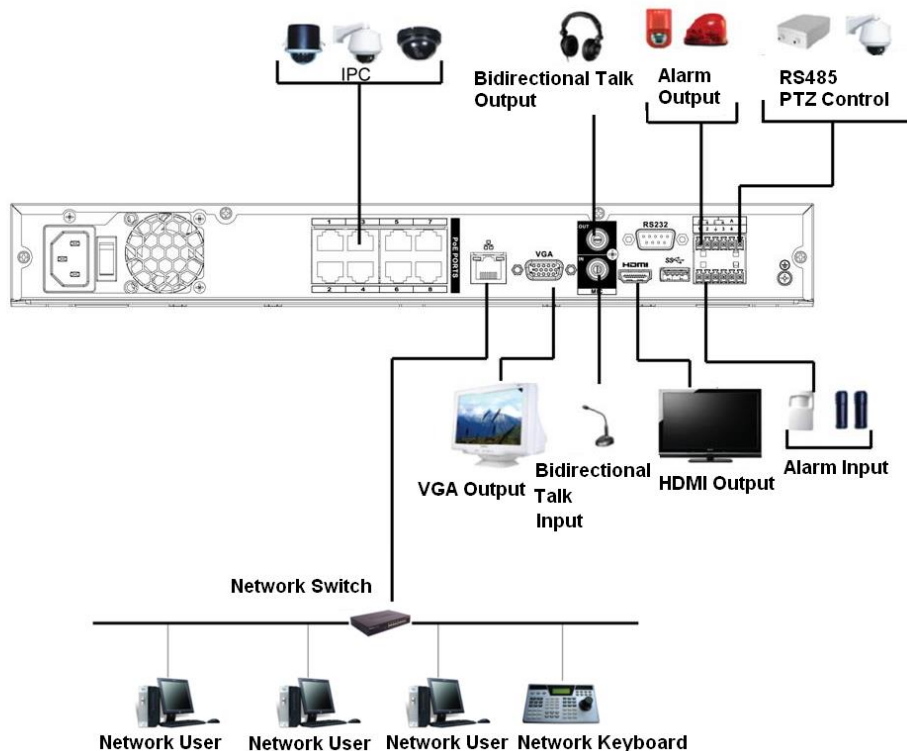

**3.6.8 General 4K 1U (S2)/Beneficio 4K 1U with 8 PoE ports/4K 1U (S2) with 4 PoE  
ports/4K 1U (S2) with 8 PoE ports/4K 1U (S2) with 16 PoE ports Series**

Please refer to Figure 3-8 for connection sample.  
The following figure for reference only.

Figure 3-8

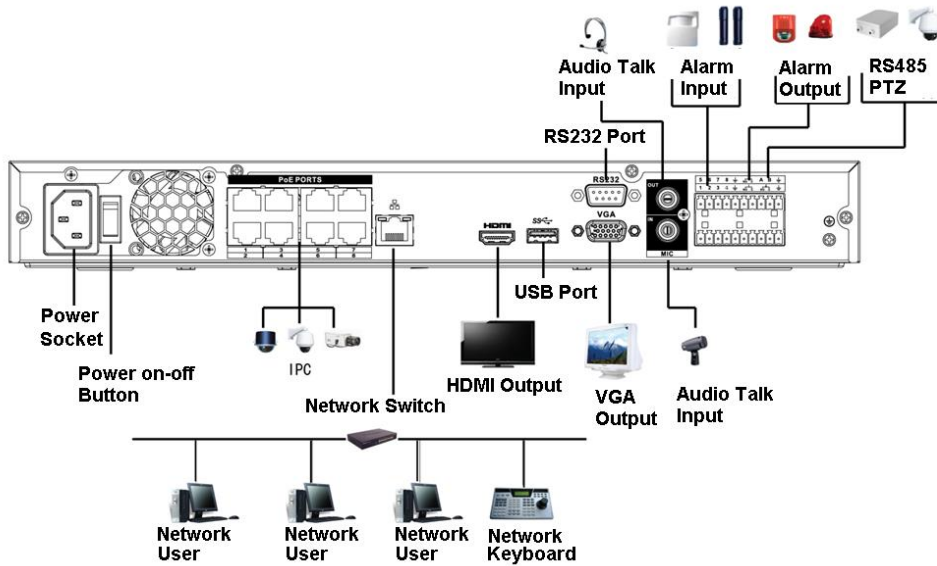

**3.6.9 Professional 4K 1.5U/ Professional 4K 1.5U with 16 PoE ports/ Professional 4K 2U / Professional 4K 2U with 16 PoE ports/4K 1.5U (S2E) with 16 PoE ports/4K 2U (S2E) with 16 PoE Ports Series**

Please refer to Figure 3-8 for connection sample.  
The following figure for reference only.

Figure 3-9

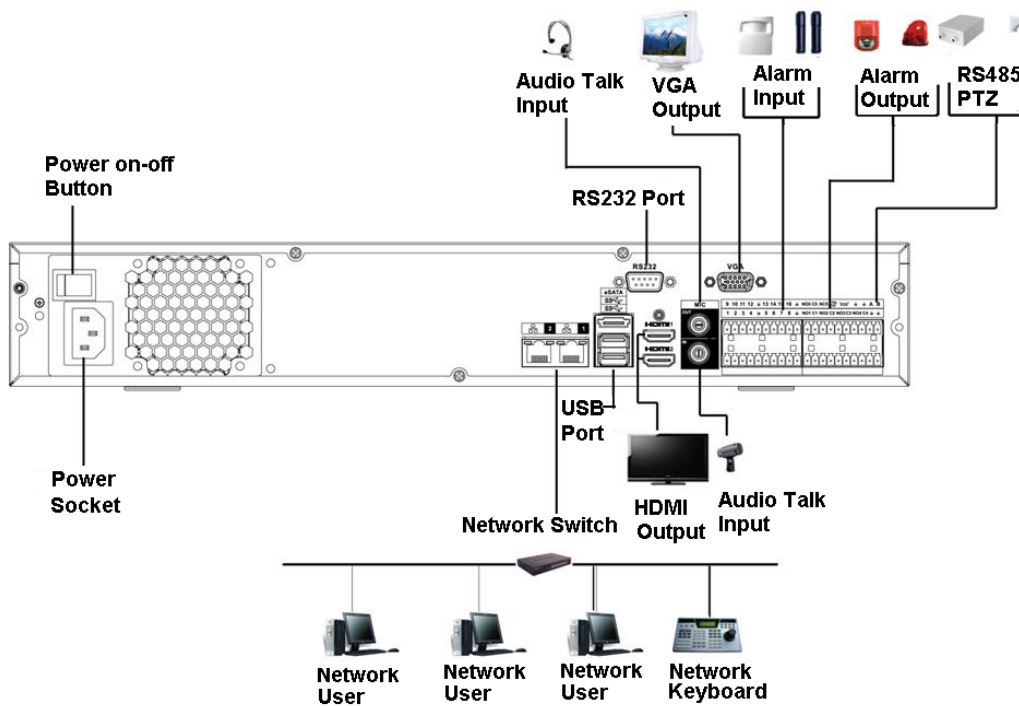

**3.6.10 Beneficio 1.5U / Beneficio 1.5U with 8 PoE ports / Beneficio 1.5U with 16 PoE ports/4K 1.5U (S2) Series**

The following figure for reference only.

Figure 3-10

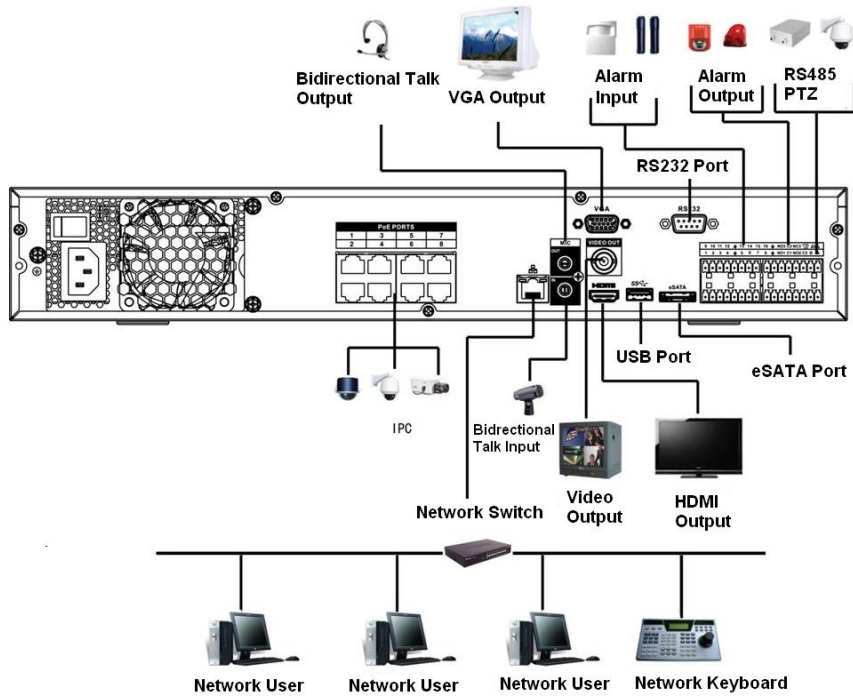

### 3.6.11 4K 2U (S2) Series

Please refer to Figure 3-11 for connection sample.  
The following figure for reference only.

Figure 3-11

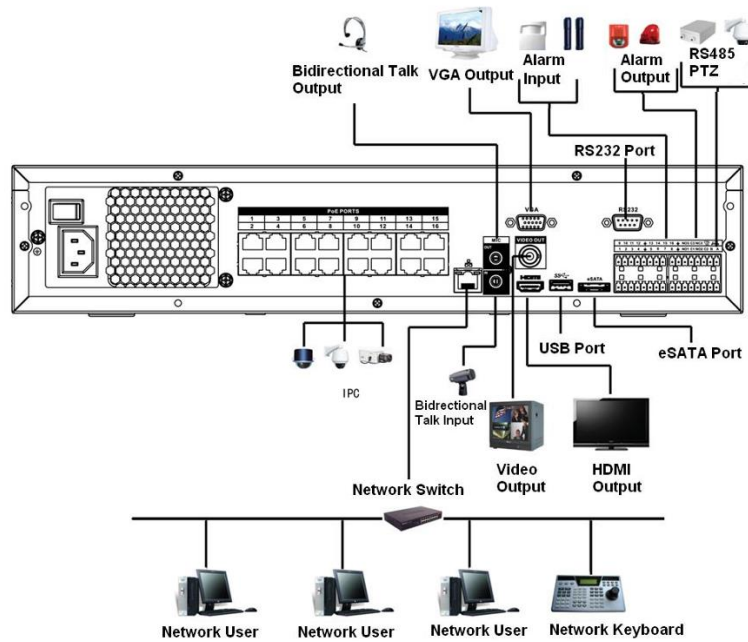

### 3.6.12 Beneficio Vertical 1U Series

Please refer to Figure 3-12 for connection sample.

Figure 3-12

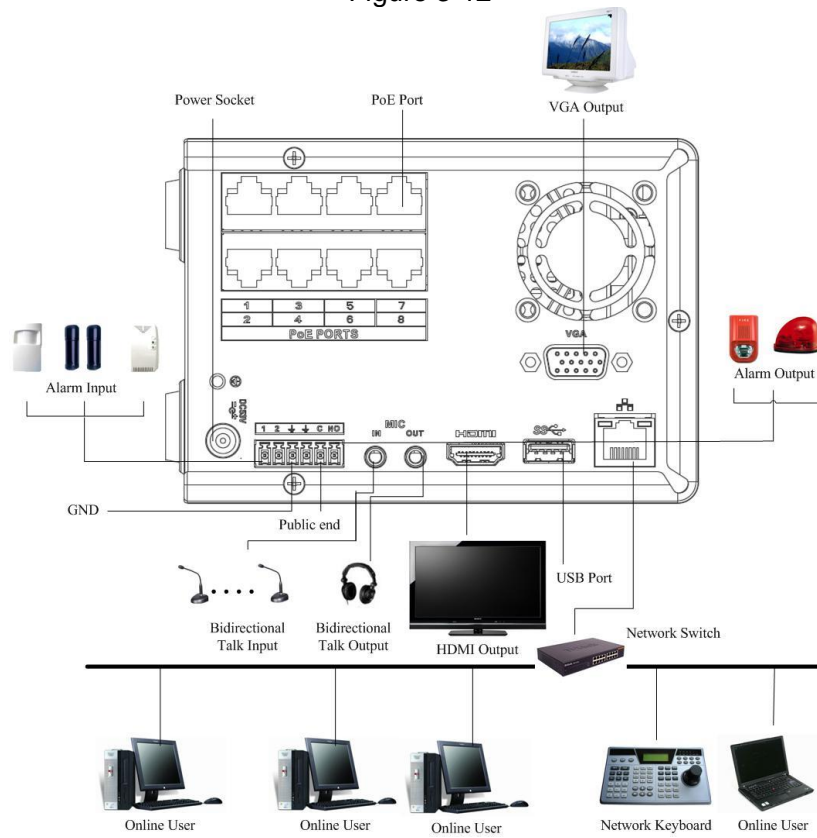

# 4 Local Basic Operation



Slight difference may be found on the user interface. The following figures for reference only.

## 4.1 Getting Started

This chapter introduces device initial settings such as boot up, device initialization, reset password, and quick settings.

### 4.1.1 Boot up



- For device security, connect the NVR to the power adapter first and then connect the device to the power socket.
- The rated input voltage matches the device power button. Make sure the power wire connection is OK. Then click the power button.
- Always use the stable current, if necessary UPS is a best alternative measure.

Step 1 Connect the device to the monitor and then connect a mouse.

Step 2 Connect power cable.

Step 3 Click the power button at the front or rear panel and then boot up the device. After device booted up, the system is in multiple-channel display mode by default.

### 4.1.2 Device Initialization

If it is your first time to use the device, set a login password of **admin** (system default user). You can select to use unlock pattern to login or not at your own choosing.



For your device safety, keep your login password of **admin** well after the initialization steps, and change the password regularly.

Step 1 Boot up NVR.

The **Device Initialization** interface is displayed. See Figure 4-1.

Figure 4-1

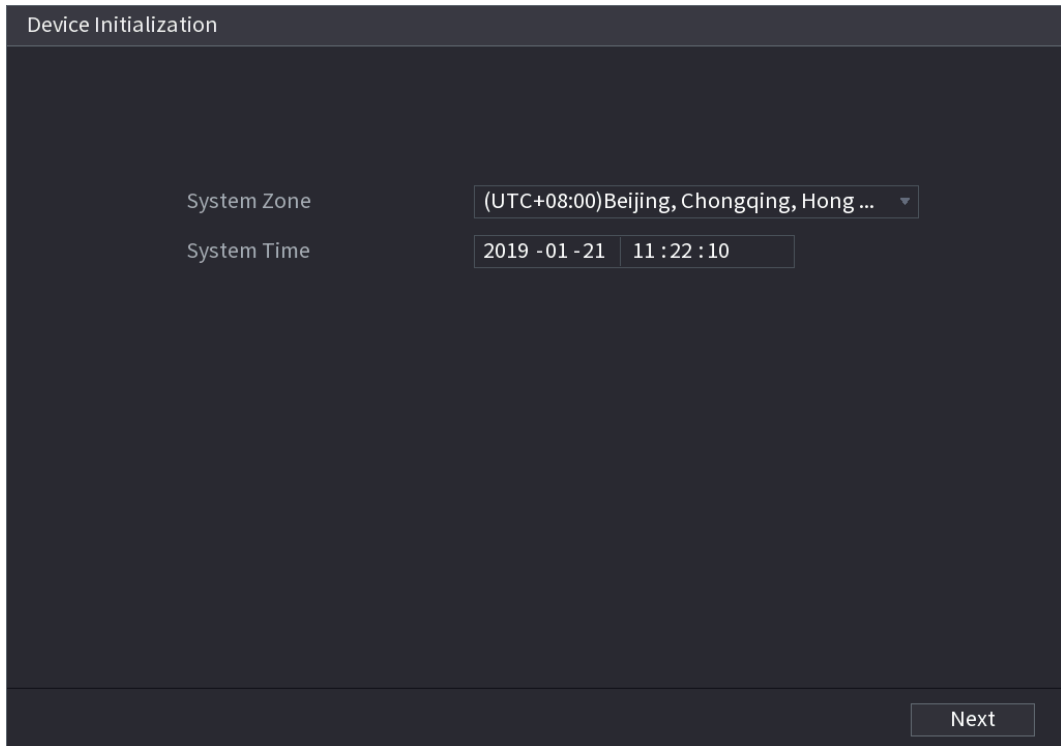

Step 2 Set system time zone according to the actual environment. Refer to Table 4-4 in "4.1.4.1.2 Date and Time" for detailed information.



Click  to shut down the device. It is suitable for the system integrator or the user to shut down directly after setting the time zone.

Step 3 Click **Next**.

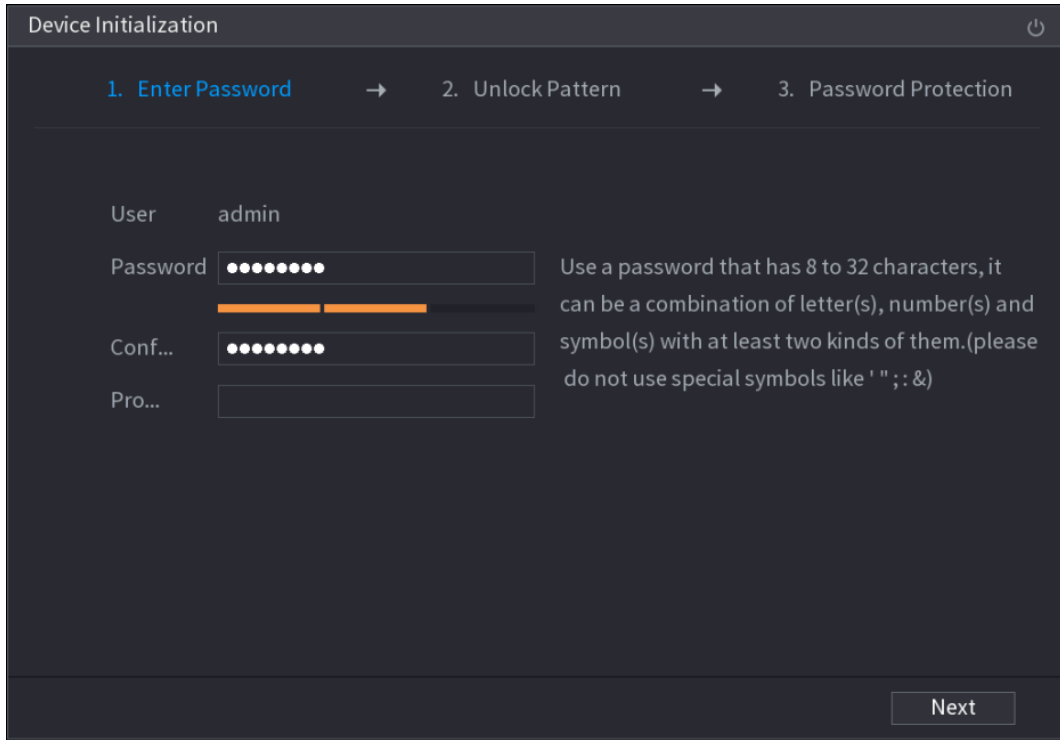

The **Device Initialization** interface is displayed. See Figure 4-2.

Figure 4-2



**Step 4** Set login password of **admin**. See Table 4-1.

Table 4-1

Parameter	Description
User	By default, the user is <b>admin</b> .
Password	In the <b>Password</b> box, enter the password for admin.
Confirm Password	The new password can be set from 8 characters through 32 characters and contains at least two types from number, letter and special characters (excluding "", "", ";", ":" and "&").
Prompt Question	In the <b>Prompt Question</b> box, enter the information that can remind you of the password.  <b>NOTE</b> On the login interface, click  , the prompt will display to help you reset the password.



For your device own safety, create a strong password of your own choosing. We also recommend you change your password periodically especially in the high security system.

**Step 5** Click **Next**.

The **Unlock Pattern** interface is displayed. See Figure 4-3.



Figure 4-3

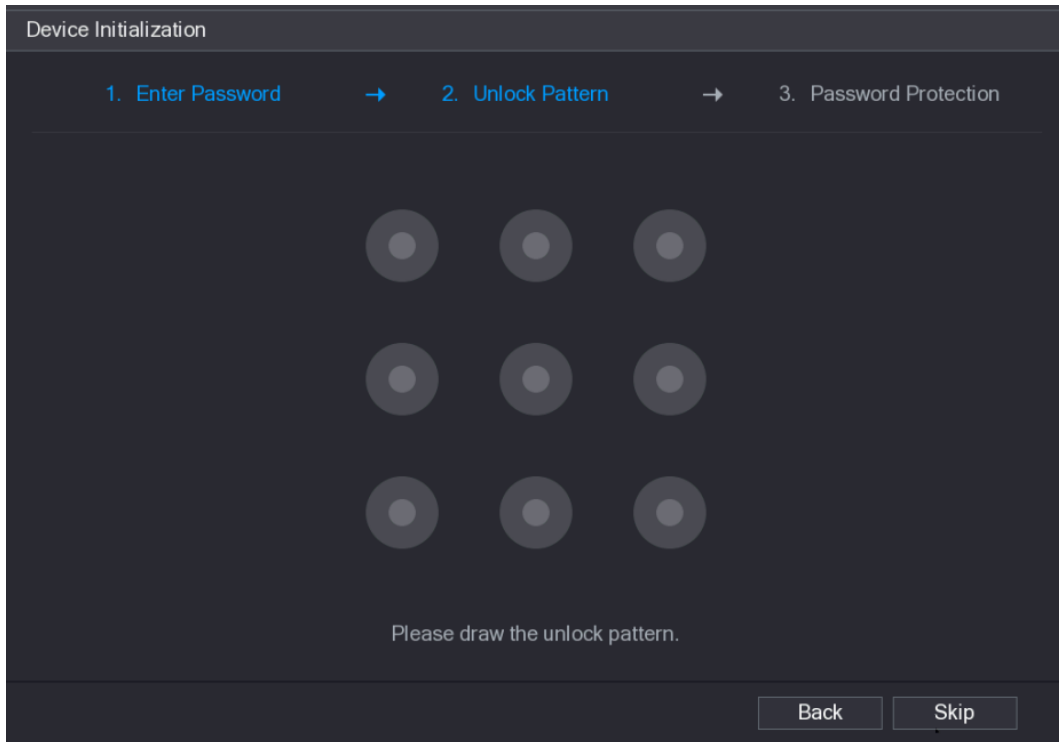

**Step 6** Set unlock pattern.

After set unlock pattern, the **Password Protection** interface is displayed. See Figure 4-4.



- The pattern that you want to set must cross at least four grids.
- If you do not want to configure the unlock pattern, click **Skip**.
- Once you have configured the unlock pattern, the system will require the unlock pattern as the default login method. If you skip this setting, enter the password for login.

Figure 4-4

**Step 7** Set security questions. See Table 4-2.

- After configuration, if you forgot the password for admin user, you can reset the password through the reserved email address or security questions. For details about resetting the password, see “4.1.3 Reset Password”.
- If you do not want to configure the settings, disable the email address and security questions functions on the interface.

Table 4-2

Password Protection Mode	Description
Email Address	Enter the reserved email address. In the <b>Email Address</b> box, enter an email address for password reset. If you forget the password, enter the security code that you will get from this reserved email address to reset the password of <b>admin</b> . Refer to " 4.16.1.2 Modify Password" for detailed information.
Security Questions	Configure the security questions and answers. If you forget the password, enter the answers to the questions can allow you reset the password. Refer to " 4.16.3 Reset Password " for detailed information.

**Step 8** Click **Save** to complete the device initialization setup.

**Step 9** Device goes to startup wizard interface. Refer to “4.1.4 Quick Settings” for detailed information.

### 4.1.3 Reset Password

You can reset the password by the following methods when you forgot the password for admin account.

- If the password reset function is enabled, you can use mobile phone to scan the QR code to reset the password. For details, see "4.1.3.2 Resetting Password on Local Interface."
- If the password reset function is disabled, there are two situations:
  - ◇ If you configured security questions, you can reset the password by the security questions.
  - ◇ If you did not configure the security questions, you can only use the reset button on the mainboard to restore the Device to factory default.



Reset button is for some series product only.

### 4.1.3.1 Enabling Password Reset Function

After enabling password reset function, you can scan QR code on the local menu to reset password.

**Step 1** Select **Main Menu > Account > Reset Password**.

The **Reset Password** interface is displayed. See Figure 4-5.

Figure 4-5

Reset Password

Enable

Email Address

Security Question

Please set a security question so that you can find the password of admin again.

Question 1

Answer

Question 2

Answer

Question 3

Answer

Apply Back

**Step 2** Check the box to enable reset function.



This function is enabled by default.

**Step 3** Click **Apply** to set settings.

If the password reset function is disabled, you can follow the ways listed below to reset password.

- Device supports Reset button on the main board: You can answer the security question on the local menu or click the Reset button on the main board to reset password. Refer to “4.1.3.3 Reset Button “for detailed information.
- Device does not support Reset button on the main board: You can only answer the security question on the local menu to reset password. (Make sure you have set security questions).

### 4.1.3.2 Resetting Password on Local Interface

**Step 1** Enter the **SYSTEM LOGIN** interface.

- If you have configured unlock pattern, the unlock pattern login interface is displayed. See Figure 4-6. Click **Forgot Pattern**, the password login interface is displayed. See Figure 4-7.
- If you did not configure unlock pattern, the **System Login** interface is displayed. See Figure 4-7.



To login from other user account, on the unlock pattern login interface, click **Switch User**, or on the password login interface, in the **Switch User** list, select other user to login.

Figure 4-6

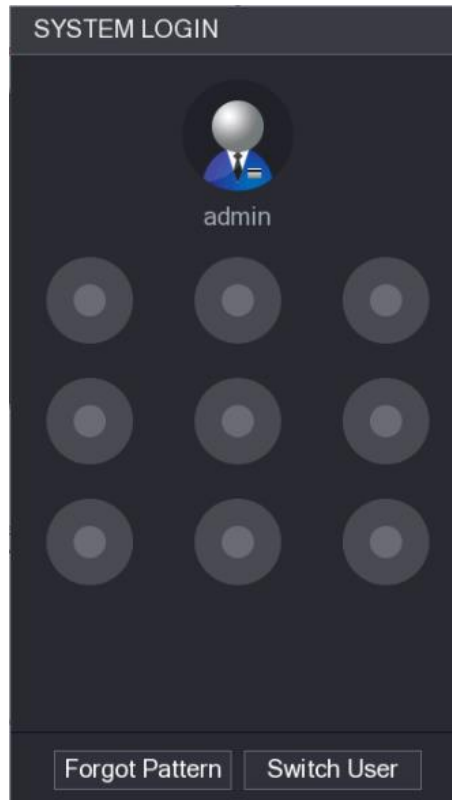
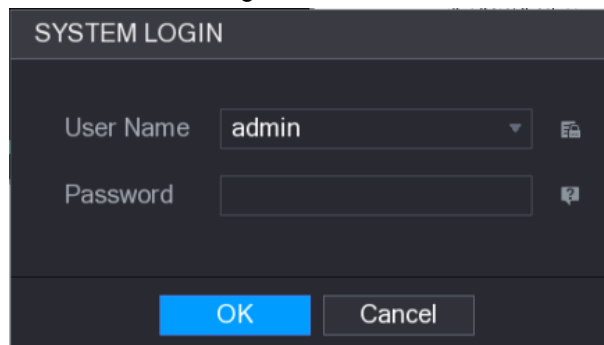



Figure 4-7



Step 2 Click .

- If you have set the reserved email address, the **Prompt** interface is displayed. See Figure 4-8.
- If you did not set the reserved email address, the email entering interface is displayed. See Figure 4-9.
- Enter the email address, and then click **Next**, the Prompt message interface is displayed. See Figure 4-8.

Figure 4-8

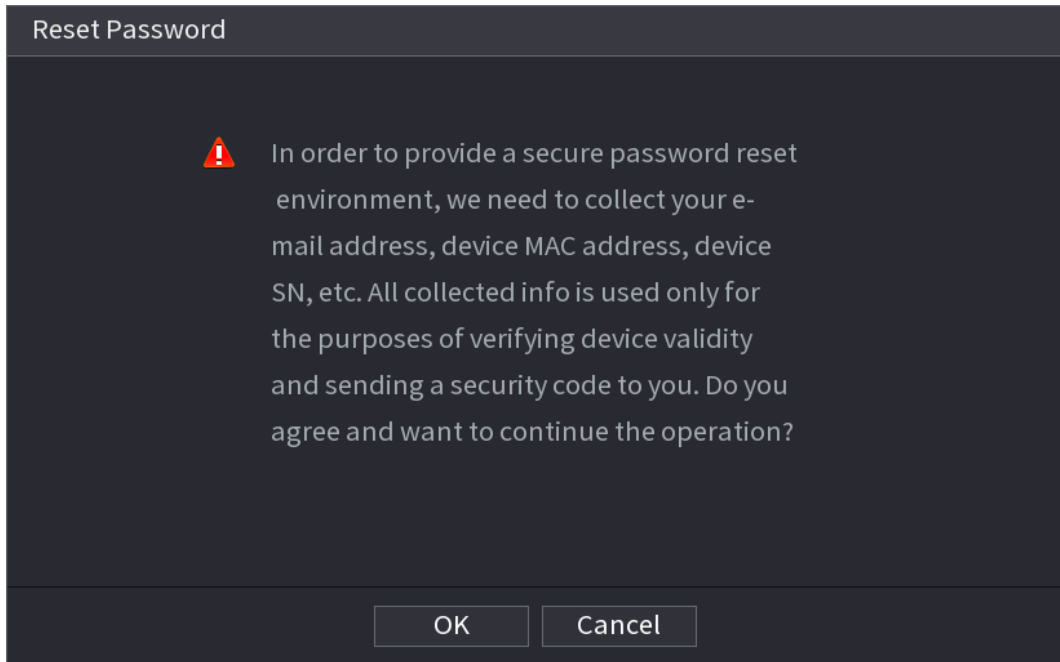
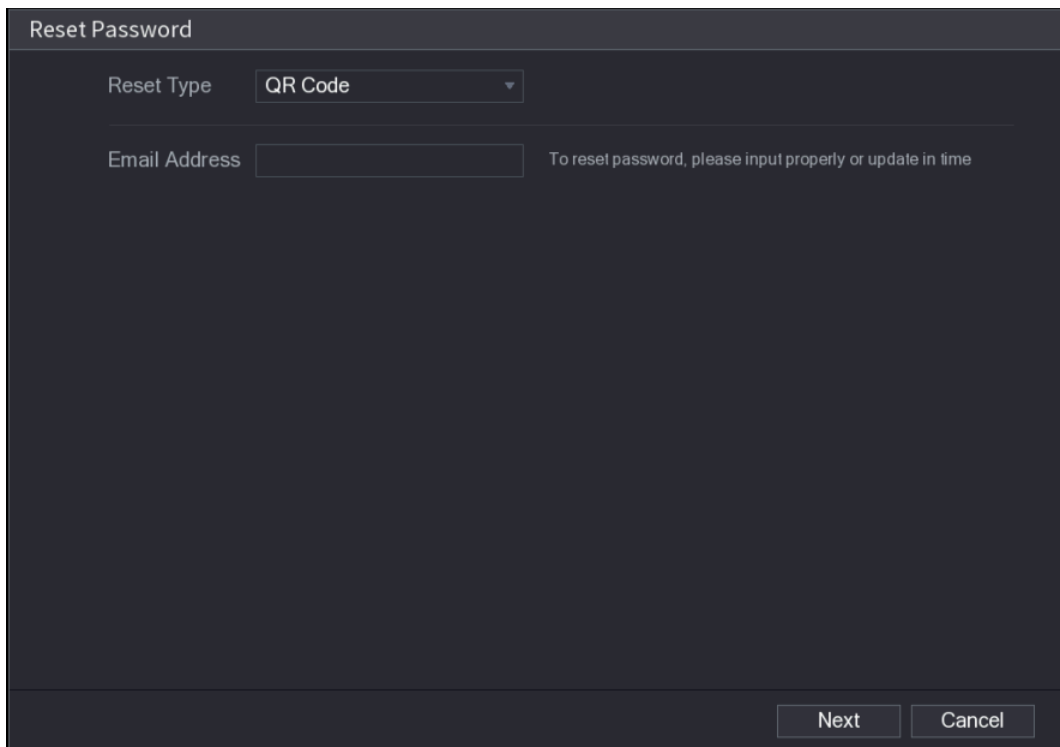

Figure 4-9



**Step 3** Click **Next**.

The **Reset Password** interface is displayed. See Figure 4-10.



After clicking **Next**, the system will collect your information for password reset, purpose and the information includes but not limited to email address, MAC address, and device serial number. Read the prompt carefully before clicking **Next**.

Figure 4-10

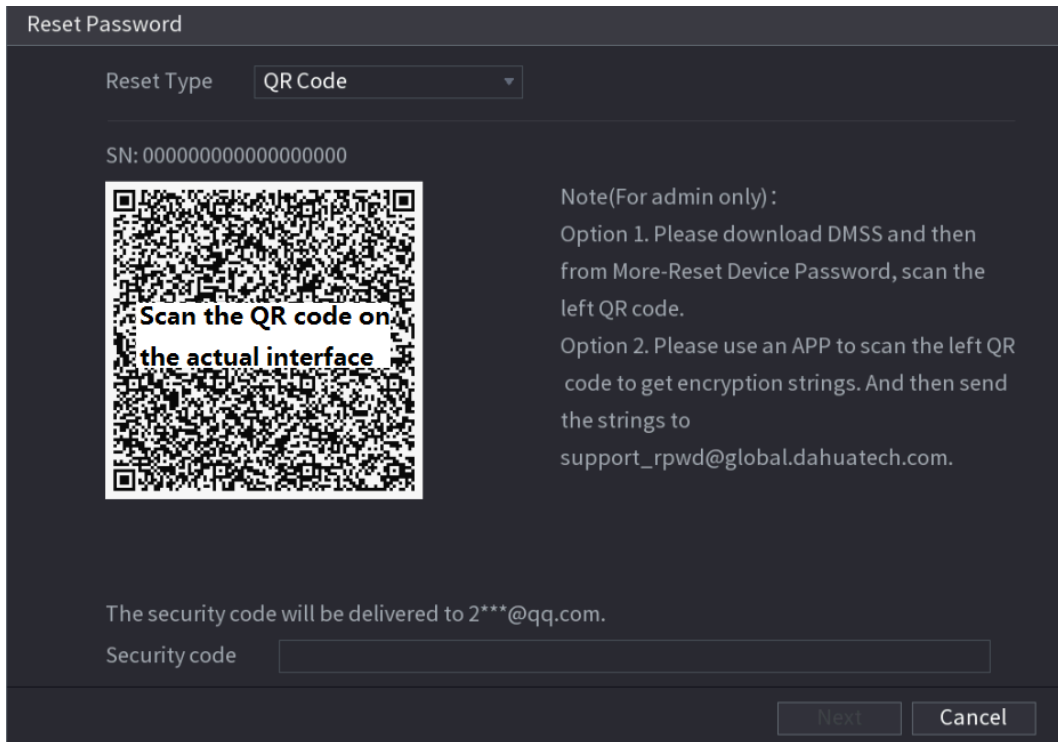

**Step 4** Reset the password.

- QR code  
Follow the onscreen instructions to get the security code in your reserved email address. In the Security code box, enter the security code.



- You can get the security code twice by scanning the same QR code. If you need to get the security code once again, refresh the interface.
- Use the security code received in your email box to reset the password within 24 hours; otherwise the security code becomes invalid.

- Security questions  
On the **Reset password** interface as shown in Figure 4-11, in the **Reset Type** list, select **Security Questions**, the Security Questions interface is displayed.



If you did not configure the security questions before, in the **Reset Type** list, there is no **Security Questions**.

Figure 4-11

Reset Password

Reset Type **Security Questions**

Question 1

Answer

Question 2

Answer

Question 3

Answer

Step 5 Click **Next**.

The **Reset Password** interface is displayed. See Figure 4-12.

Figure 4-12

Reset Password

Reset password of (admin)

New Password

Use a password that has 8 to 32 characters, it can be a combination of letter(s), number(s) and symbol(s) with at least two kinds of them.(please do not use special symbols like ' "; : &)

Confirm Password

Step 6 In the **New Password** box, enter the new password and enter it again in the **Confirm Password** box.

Step 7 Click **Save**. The password resetting is complete.

A pop-up message is displayed asking if you want to sync the password with the remote devices. See Figure 4-13.

Figure 4-13

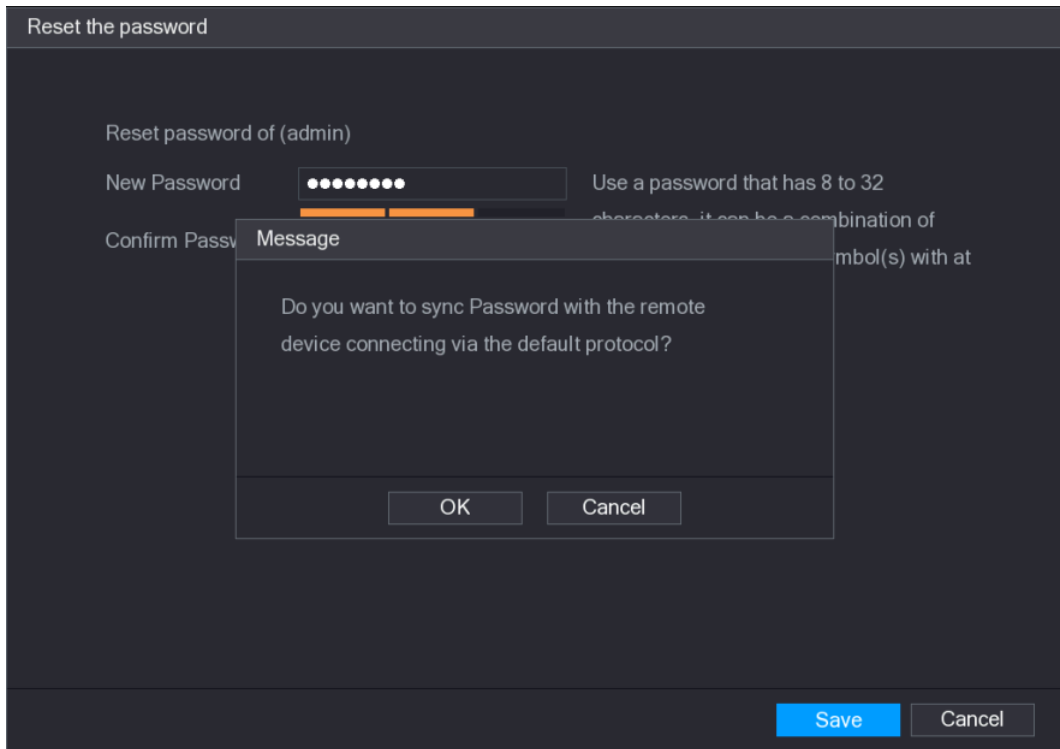

#### 4.1.3.3 Reset Button

You can always use the reset button on the mainboard to reset the Device to the factory default settings.



Reset button is for some series products only.

**Step 1** Disconnect the Device from power source, and then remove the cover panel. For details about removing the cover panel, see “3.4 HDD Installation.”

**Step 2** Find the reset button on the mainboard, and then connect the Device to the power source again.

**Step 3** Press and hold the reset button for 5 seconds to 10 seconds. See Figure 4-14 for the location of the reset button.

Figure 4-14

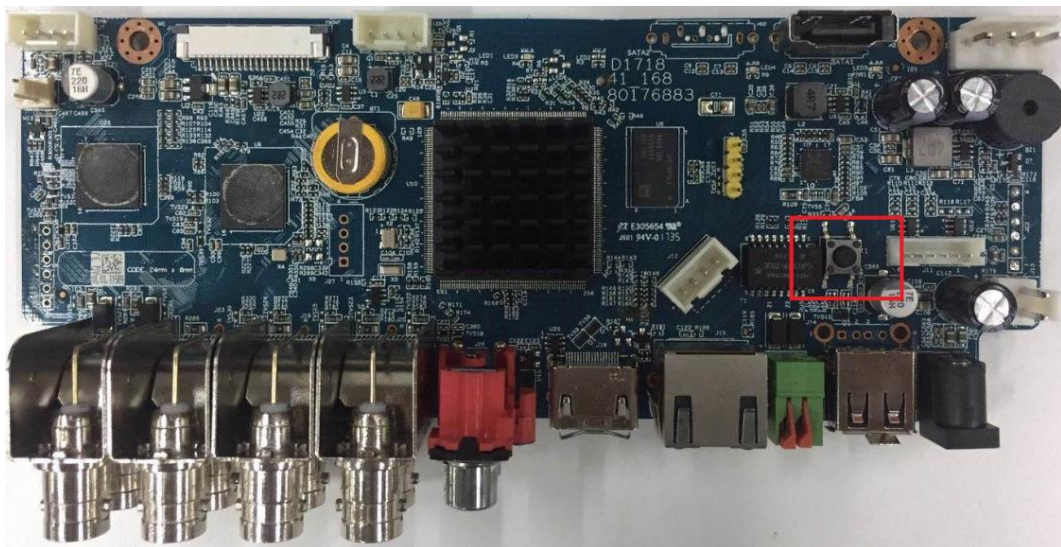

**Step 4** Reboot the Device.



After the Device is rebooted, the settings have been restored to the factory default. You can start resetting the password.

#### 4.1.4 Quick Settings

After you successfully initialized the device, it goes to startup wizard. Here you can quickly configure your device. Click **Next**, device goes to **General** interface.



The startup wizard interface only displays after you first login the device and have set the admin password. See Figure 4-15.

Figure 4-15

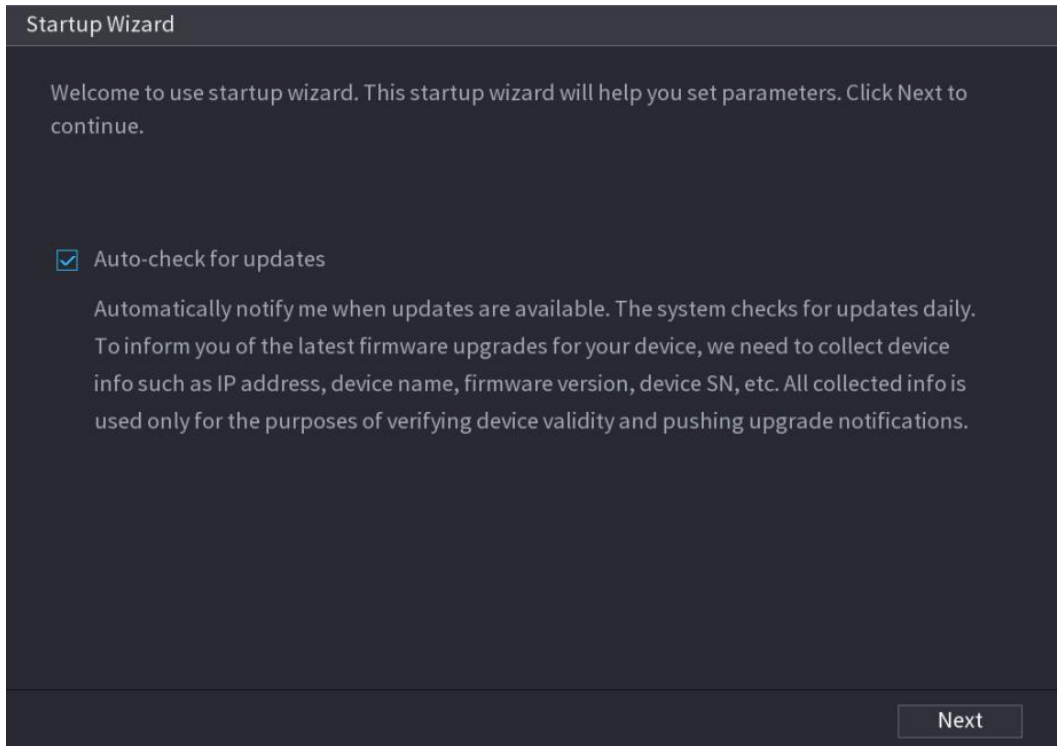

- If you select the **Auto-check for updates** check box, the system will notify you automatically when updates are available.
- After the auto-check function is enabled, to notify you to update timely, the system will collect the information such as IP address, device name, firmware version, and device serial number. The collected information is only used to verify the legality of the Device and push upgrade notices.
- If you cancel the **Auto-check for updates** check box, the system will not perform automatic checks.

##### 4.1.4.1 General

You can set NVR basic information such as system date, holiday and etc. You can also configure general settings by selecting **Main Menu > SYSTEM > General**.

###### 4.1.4.1.1 General

You can set device basic information such as device name, serial number.

Step 1 Click **Next**.

The **General** interface is displayed. See Figure 4-16.

Figure 4-16

The screenshot shows a configuration window titled "General" with the following settings:

- Device Name: NVR
- Device No.: 8
- Language: ENGLISH
- Video Standard: PAL
- Sync to Remote Device:  (Include language, ...)
- Instant Replay(Min.): 5
- Auto Logout(Min.): 10
- IPC Time Sync:
- IPC Time Sync Period (hour): 24
- Navigation Bar:
- Mouse Sensitivity: Slider between Slow and Fast

Buttons for "Back" and "Next" are visible at the bottom right.

**Step 2** Set parameters. See Table 4-3.

Table 4-3

Parameter	Description
Device Name	In the <b>Device Name</b> box, enter the Device name.
Device No.	In the <b>Device No.</b> box, enter a number for the Device.
Language	In the <b>Language</b> list, select a language for the Device system.
Video Standard	In the <b>Video Standard</b> list, select <b>PAL</b> or <b>NTSC</b> according to your actual situation.
Sync to Remote Device	Enable this function; the NVR can synchronize information with the remote device such as Language, video standard, time zone.
Instant Play (Min.)	In the <b>Instant Play</b> box, enter the time length for playing back the recorded video. The value ranges from 5 to 60. On the live view control bar, click the instant playback button to play back the recorded video within the configured time.
Auto Logout (Min.)	In the <b>Auto Logout</b> box, enter the standby time for the Device. The Device automatically logs out when it is not working for the configured time period. You need to login the Device again. The value ranges from 0 to 60. 0 indicates there is not standby time for the Device. Click <b>Monitor Channel(s) when logout</b> . You can select the channels that you want to continue monitoring when you logged out.
IPC Time Sync	Syncs the Device time with IP camera.
IPC Time Sync Period (hour)	In the <b>IPC Time Sync Period</b> box, enter the interval for time sync.
Auto logout	You can set auto logout interval once login user remains inactive for a specified time. Value ranges from 0 to 60 minutes.
Navigation Bar	Enable the navigation bar. When you click on the live view screen, the navigation bar is displayed.

Parameter	Description
Mouse Sensitivity	Adjust the speed of double-click by moving the slider. The bigger the value is, the faster the speed is.

**Step 3** Click **Next** button to save settings.

#### 4.1.4.1.2 Date and Time

You can set device time. You can enable NTP (Network Time Protocol) function so that the device can sync time with the NTP server.

You can also configure date and time settings by selecting **Main Menu > SYSTEM > GENERAL > Date&Time**.

**Step 1** Click **Date & Time** tab. See Figure 4-17.

Figure 4-17

**Step 2** Configure the settings for date and time parameters. See Table 4-4.

Table 4-4

Parameter	Description
System Time	In the <b>System Time</b> box, enter time for the system. Click the time zone list, you can select a time zone for the system, and the time in adjust automatically.  Do not change the system time randomly; otherwise the recorded video cannot be searched. It is recommended to avoid the recording period or stop recording first before you change the system time.
System Zone	In the <b>System Zone</b> list, select a time zone for the system.
Date Format	In the <b>Date Format</b> list, select a date format for the system.
Date Separator	In the <b>Date Separator</b> list, select a separator style for the date.
Time Format	In the <b>Time Format</b> list, select <b>12-HOUR</b> or <b>24-HOUR</b> for the time display style.
DST	Enable the Daylight Saving Time function. Click <b>Week</b> or click <b>Date</b> .

Parameter	Description
Start Time	Configure the start time and end time for the DST.
End Time	
NTP	Enable the NTP function to sync the Device time with the NTP server.  If NTP is enabled, device time will be automatically synchronized with server.
Server	In the <b>Server</b> box, enter the IP address or domain name of the corresponding NTP server. Click <b>Manual Update</b> , the Device starts syncing with the server immediately.
Port	The system supports TCP protocol only and the default setting is 123.
Interval (Min.)	In the <b>Interval</b> box, enter the amount of time that you want the Device to sync time with the NTP server. The value ranges from 0 to 65535.

**Step 3** Click **Next** button to save settings.

#### 4.1.4.1.3 Holiday

Here you can add, edit, delete holiday. After you successfully set holiday information, you can view holiday item on the record and snapshot period.

You can also configure holiday settings by selecting **Main Menu > SYSTEM > GENERAL > Holiday**.

**Step 1** Click **Next**.

The **Holiday** interface is displayed. See Figure 4-18.

Figure 4-18

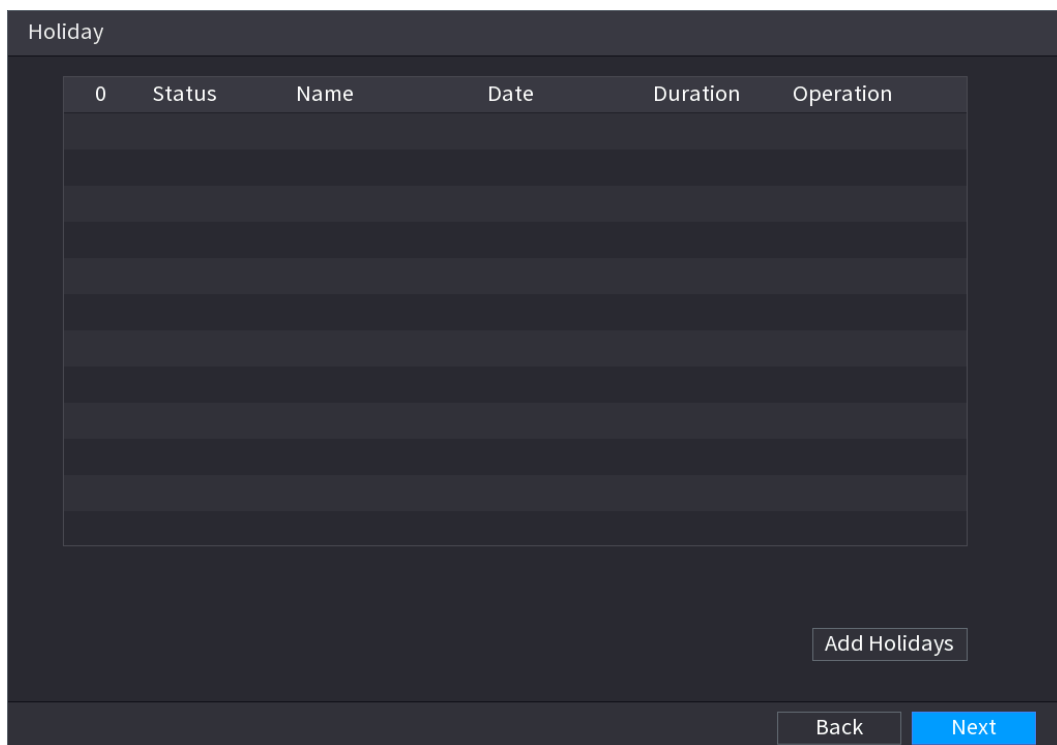

**Step 2** Click **Add Holidays** button, the **Add Holidays** interface is displayed. See Figure 4-19.

Figure 4-19

Add Holidays

Holiday Name

Repeat Mode  Once  Always

Holiday Range  Date  Week

Start Time 2000 - 01 - 01

End Time 2000 - 01 - 01

Add More

Add Cancel

**Step 3** Set holiday name, repeat mode and holiday mode.



Click **Add more** to add new holiday information.

**Step 4** Click **Add** button, you can add current holiday to the list.



- Click the dropdown list of the state; you can enable/disable holiday date.
- Click to change the holiday information. Click to delete current date.

**Step 5** Click **Next** button to save settings.

#### 4.1.4.2 Basic Network Settings

You can set device IP address, DNS (Domain Name System) information. You can also configure basic network settings by selecting **Main Menu > NETWORK > TCP/IP**.

### Preparation

Make sure the device has properly connected to the network.

**Step 1** Click **Next**.

The **TCP/IP** interface is displayed.



Different series products have different Ethernet adapter amount and type. Refer to the actual product.

Figure 4-20

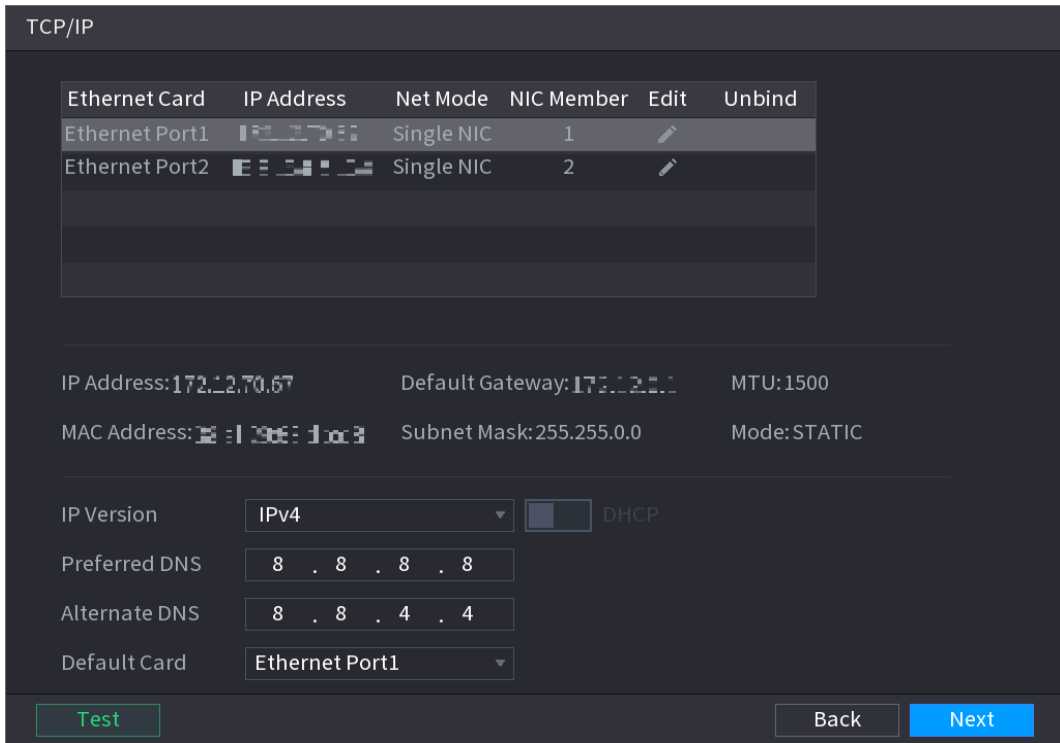

Step 2 Click .

The **Edit** interface is displayed. See Figure 4-21.

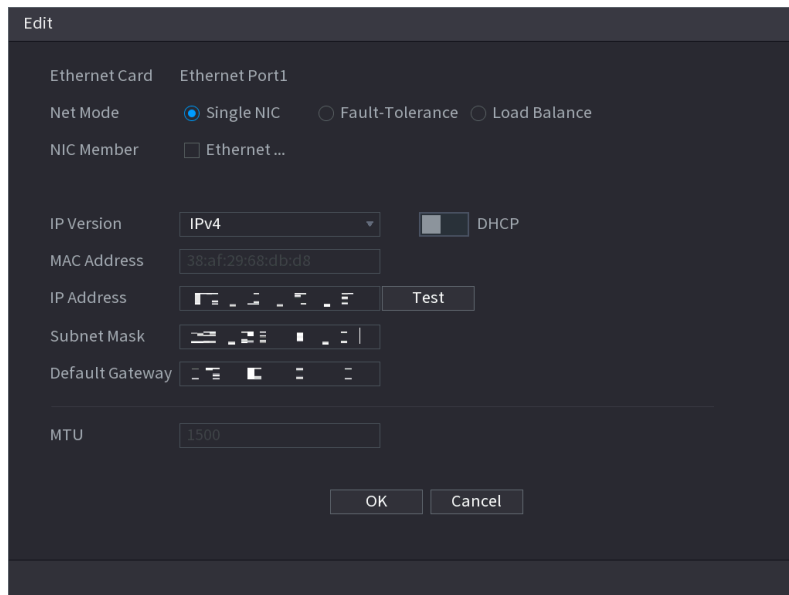

Figure 4-21



Step 3 Set parameters. See Table 4-5.

Table 4-5

Parameter	Description
Net Mode	<ul style="list-style-type: none"> <li> <b>Multi-address:</b> Two Ethernet ports work separately through either of which you can request the Device to provide the services such as HTTP and RTSP. You need to configure a default Ethernet port (usually the Ethernet port 1 by default) to request the services from the device end such as DHCP, Email and FTP. If one of the two Ethernet ports is disconnected as detected by networking testing, the system network status is regarded as offline.         </li> <li> <b>Fault Tolerance:</b> Two Ethernet ports share one IP address.         </li> </ul>

Parameter	Description
	<p>Normally only one Ethernet port is working and when this port fails, the other port will start working automatically to ensure the network connection.</p> <ul style="list-style-type: none"> <li>When testing the network status, the network is regarded as offline only when both of the two Ethernet ports are disconnected. The two Ethernet ports are used under the same LAN.</li> <li><b>Load Balance:</b> Two network cards share one IP address and they are working at the same time to share the network load averagely. If one of them fails, the other can continue working normally.</li> <li>When testing the network status, the network is regarded as offline only when both of the two Ethernet ports are disconnected. The two Ethernet ports are used under the same LAN.</li> </ul>  <p>The Device with single Ethernet port does not support this function.</p>
Default Ethernet Port	In the <b>Ethernet Card</b> list, select an Ethernet port as a default port. This setting is available only when the <b>Multi-address</b> is selected in the <b>Net Mode</b> list.
IP Version	In the <b>IP Version</b> list, you can select <b>IPv4</b> or <b>IPv6</b> . Both versions are supported for access.
MAC Address	Displays the MAC address of the Device.
DHCP	<p>Enable the DHCP function. The IP address, subnet mask and default gateway are not available for configuration once DHCP is enabled.</p> <ul style="list-style-type: none"> <li>If DHCP is effective, the obtained information will display in the <b>IP Address</b> box, <b>Subnet Mask</b> box and <b>Default Gateway</b> box. If not, all values show 0.0.0.0.</li> <li>If you want manually configure the IP information, disable the DHCP function first.</li> <li>If PPPoE connection is successful, the IP address, subnet mask, default gateway, and DHCP are not available for configuration.</li> </ul>
IP Address	<p>Enter the IP address and configure the corresponding subnet mask and default gateway.</p>  <p>IP address and default gateway must be in the same network segment.</p>
Subnet Mask	
Default Gateway	
DNS DHCP	Enable the DHCP function to get the DNS address from router.
Preferred DNS	In the <b>Preferred DNS</b> box, enter the IP address of DNS.
Alternate DNS	In the <b>Alternate DNS</b> box, enter the IP address of alternate DNS.
MTU	In the <b>MTU</b> box, enter a value for network card. The value ranges from 1280 byte through 1500 byte. The default is 1500.
Test	Click <b>Test</b> to test if the entered IP address and gateway are interworking.

Step 4 Click OK to NIC settings.  
Device goes back to **TCP/IP** interface.

Step 5 Set network parameters. See Table 4-6.

Table 4-6

Parameter	Description
IP Version	There are two options: IPv4 and IPv6. Right now, system supports these two IP address format and you can access via them.
Preferred DNS server	DNS server IP address.
Alternate DNS server	DNS server alternate address.
MAC Address	Displays the MAC address of the Device.
DHCP	<p>Enable the DHCP function. The IP address, subnet mask and default gateway are not available for configuration once DHCP is enabled.</p> <ul style="list-style-type: none"> <li>● If DHCP is effective, the obtained information will display in the <b>IP Address</b> box, <b>Subnet Mask</b> box and <b>Default Gateway</b> box. If not, all values show 0.0.0.0.</li> <li>● If you want manually configure the IP information, disable the DHCP function first.</li> <li>● If PPPoE connection is successful, the IP address, subnet mask, default gateway, and DHCP are not available for configuration.</li> </ul>
LAN download	<p>System can process the downloaded data first if you enable this function. The download speed is 1.5X or 2.0X of the normal speed.</p>  <ul style="list-style-type: none"> <li>● For IPv6 version, the IP address, default gateway, preferred DNS; alternate DNS is 128-digit. Fill in all items here.</li> <li>● This function is for some series product only.</li> </ul>

Step 6 Click **Next** to complete the settings.

#### 4.1.4.3 P2P

Scan the QR code, download the App to the cell phone, you can use the smart phone to add the device.

- Scan the QR code on the actual interface to download the cell phone app. Register an account and then use.
- Go to the [www.easy4ip.com](http://www.easy4ip.com) to register an account and use the SN to add a device. Refer to the P2P operation manual for detailed information.



Before using the P2P function, make sure that the NVR has connected to the WAN.

Step 1 Click **Next** button.

The **P2P** interface is displayed. See Figure 4-22.



Select **Main Menu > Network > P2P**, you can go to **P2P** interface too.



Figure 4-22

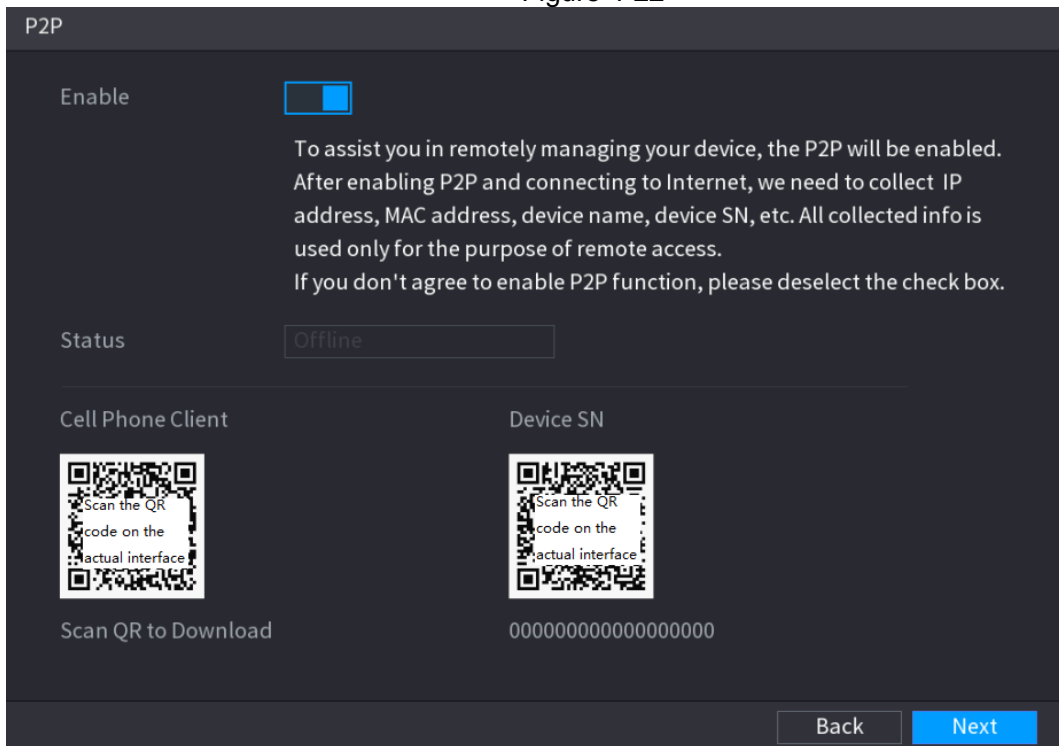

**Step 2** Check the box to enable P2P function.



After the P2P function is enabled and connected to the Internet, the system will collect your information for remote access, and the information includes but not limited to email address, MAC address, and device serial number.

**Step 3** Click **Next** button to complete setup.

The status is online if the P2P registration is successful.

## Client Operation

**Step 1** Use your cell phone to scan the QR code under Cell Phone Client to download the application.

**Step 2** On your cell phone, open the application, and then tap .

**Step 3** The menu is displayed. You can start adding the device.

1) Tap **Device Manager**.

The **Device Manager** interface is displayed. See Figure 4-23.

Figure 4-23

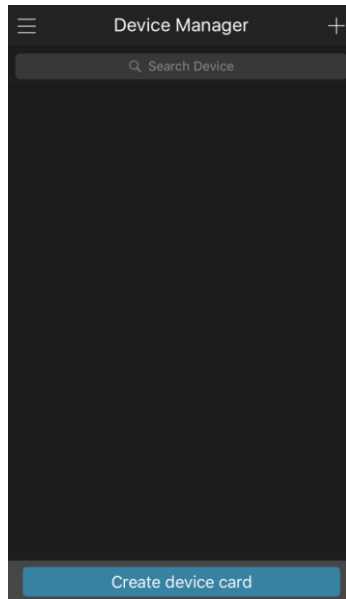

- 2) Tap  on the top right corner.  
The interface requiring device initialization is displayed. A pop-up message reminding you to make sure the Device is initialized is displayed.
- 3) Tap **OK**.
  - ◇ If the Device has not been initialized, Tap **Device Initialization** to perform initializing by following the onscreen instructions.
  - ◇ If the Device has been initialized, you can start adding it directly.
- 4) Tap **Add Device**.  
The **Add Device** interface is displayed. See Figure 4-24.



You can add wireless device or wired device. The Manual takes adding wired device as an example.

Figure 4-24

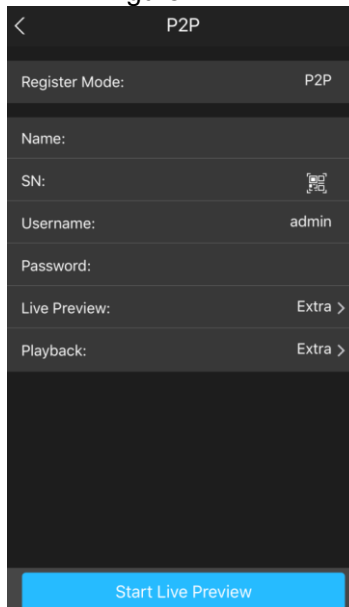

- 5) Tap **P2P**.  
The **P2P** interface is displayed. See Figure 4-25.

Figure 4-25

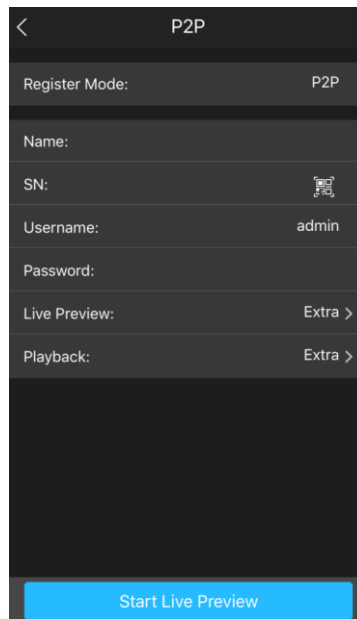

- 6) Enter a name for the NVR, the username and password, scan the QR code under **Device SN**.
- 7) Tap **Start Live Preview**.  
The Device is added and displayed on the live view interface of the cell phone. See Figure 4-26.

Figure 4-26



#### 4.1.4.4 Registration



If you do not select Smart add function during the initialization process, go to the remote Device interface to register a remote device.

After adding remote device, the device can receive, store, and manage the video streams of the remote device. You can view, browse, play back and manage several remote devices at the same time.

Step 1 On the **P2P** interface, click **Next** button.

The **REGISTRATION** interface is displayed. See Figure 4-27.



There are two ways to go to Registration interface.

- Select **Main Menu > CAMERA > REGISTRATION > Camera Registration**, you

- can go to the **Camera Registration** interface.
- On the preview interface, right click mouse and then select **Camera Registration**.

Figure 4-27

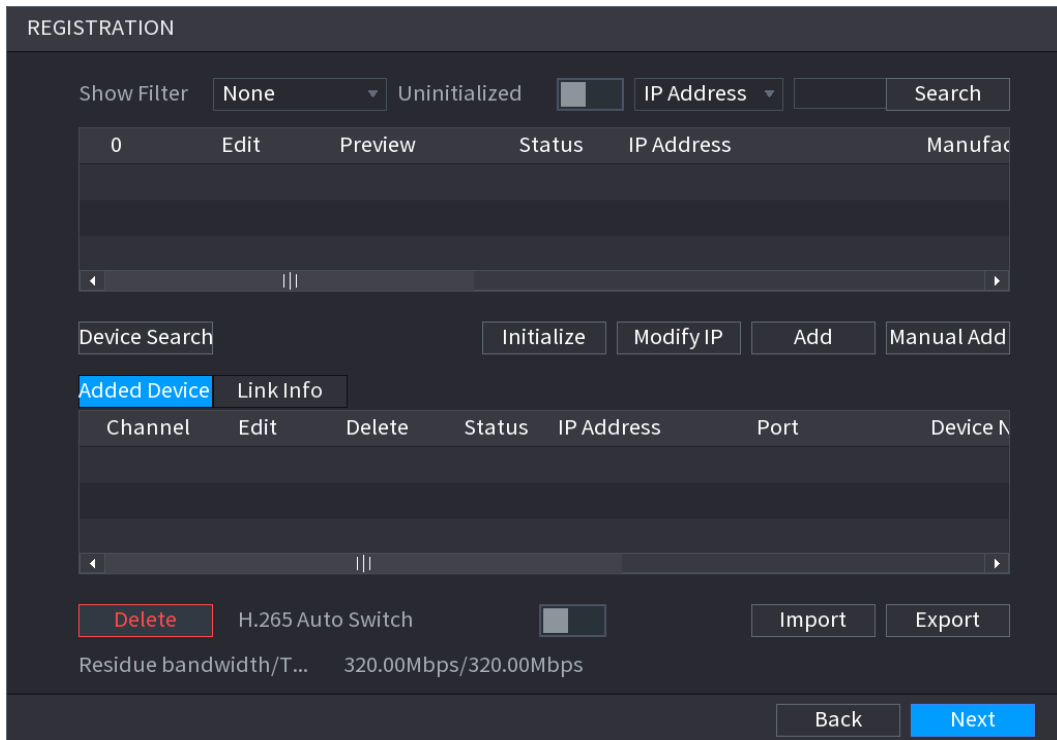

**Step 2** Register remote device.

- Search and then add
  - 1) Click **Device Search**.  
System displays searched devices at the upper pane.
  - 2) Double-click a remote device, or select a remote device and then click **Add** to register it to the **Added Device** list.
  - 3) . Refer to
  - 4) Table 4-7 to set parameters.



The search results do not display the remote camera that has registered to the system

Figure 4-28

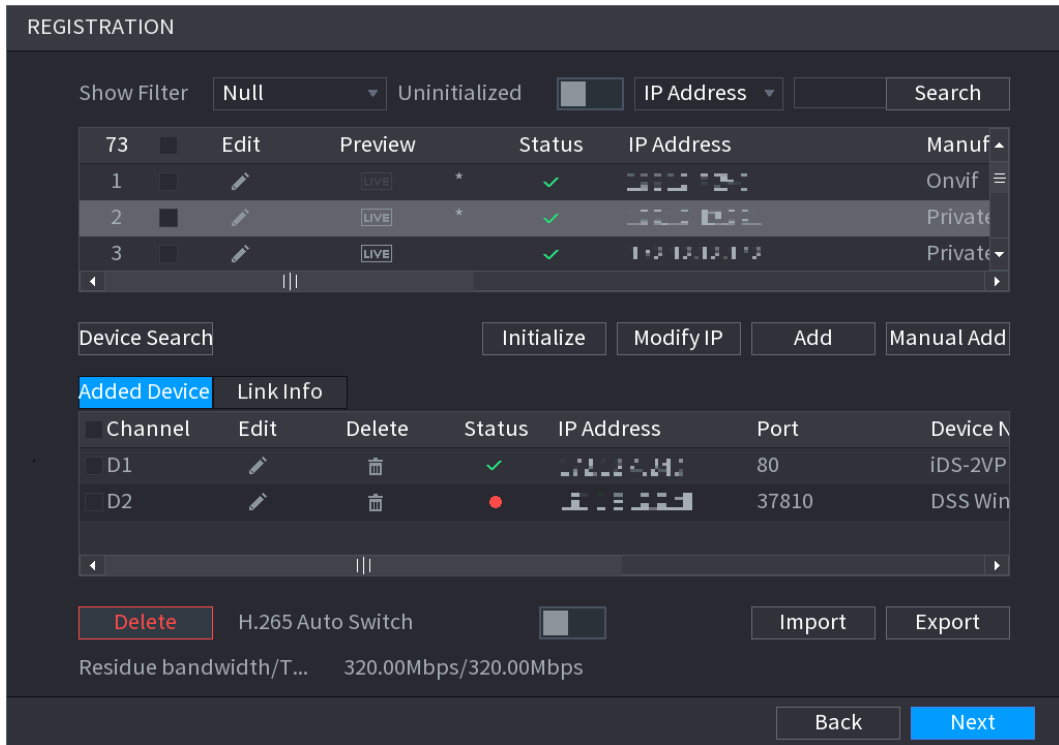
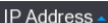



Table 4-7

Parameter	Description
Uninitialized	Enable the <b>Uninitialized</b> function, the uninitialized devices out of the searched devices are displayed in the searched device list.
Initialize	Select the uninitialized device from the uninitialized device list, and the click <b>Initialize</b> to start initializing device.
Show Filter	In the <b>Show Filter</b> list, select the remote device type that you want to display in the searched device list. <ul style="list-style-type: none"> <li>None: Display all types of devices.</li> <li>IPC: Display the front-end devices.</li> <li>DVR: Display all storage devices such as NVR, DVR and HCVR.</li> <li>OTHER: Display the devices that do not belong to IPC or DVR type.</li> </ul>
Searched Device List	Displays the searched devices. You can view the device information such as status, IP address.
Device Search	Click <b>Device Search</b> , the searched devices display in the searched device list. To adjust the display sequence, in the title line, you can click the IP address, Manufacturer, Type, MAC Address, Port, or Device Name text. For example, click the IP address text, the sequence icon  is displayed.  "*" is displayed next to the added device.
Add	In the Searched Device List area, select the device that you want to add.
Manual Add	Add the device by manually configuring settings such as IP address, channel selection.
Added Device List	Displays the added devices. You can edit and delete the device, and view the device information.
Delete	Select the check box of the added device, and then click <b>Delete</b> to delete the added device.
Import	Select the searched devices and then click <b>Import</b> to import the devices in batches.

Parameter	Description
Export	Select the added devices and then click <b>Export</b> . The exported devices information is saved into the USB storage device.

- Manual Add
  - 1) Click **Manual Add**.
    - The **Manual Add** interface is displayed. See Figure 4-29.

Figure 4-29

- 2) Configure parameters. See Table 4-8.

Table 4-8

Parameter	Description
Channel	In the <b>Channel</b> list, select the channel that you want use on the Device to connect the remote device.
Manufacturer	In the <b>Manufacturer</b> list, select the manufacturer of the remote device.
IP Address	In the <b>IP Address</b> box, enter the IP address of remote device.  The default is 192.168.0.0 which the system cannot connect to.
RTSP Port	The default value setting is 554. You can enter the value according to your actual situation.
HTTP Port	The default value setting is 80. You can enter the value according to your actual situation. If you enter other value, for example, 70, and then you should enter 70 after the IP address when logging in the Device by browser.
User Name	Enter the user name of the remote device.
Password	Enter the password of the user for the remote device.
Remote Channel	Enter the remote channel number of the remote device that you want to add.
Decoder Buffer	In the <b>Decoder Buffer</b> list, select <b>Default</b> , <b>Realtime</b> , or <b>Fluent</b> .
Protocol Type	<ul style="list-style-type: none"> <li>• If the remote device is added through private protocol, the default type is <b>TCP</b>.</li> <li>• If the remote device is added through Onvif protocol, the system</li> </ul>

Parameter	Description
	supports <b>Auto</b> , <b>TCP</b> , <b>UDP</b> , or <b>MULTICAST</b> . <ul style="list-style-type: none"> <li>If the remote device is added through other manufacturers, the system supports <b>TCP</b> and <b>UDP</b>.</li> </ul>
Encrypt	If the remote device is added through Onvif protocol, selecting the <b>Encrypt</b> check box will provide encryption protection to the data being transmitted.  <p>To use this function, the HTTPS function should be enabled for the remote IP camera.</p>

3) Click **OK**.

The remote device information is displayed on the **Added Device** list.

**Step 4** Click **Next** to complete the remote device registration.



Click  to change the remote device information. Click  to delete remote device.

Once the multiple-sensor device has registered to the device system displays the channel status on the **Link info**. See Figure 4-30. It shows one remote device has occupied two channels: D1, D3.

Figure 4-30

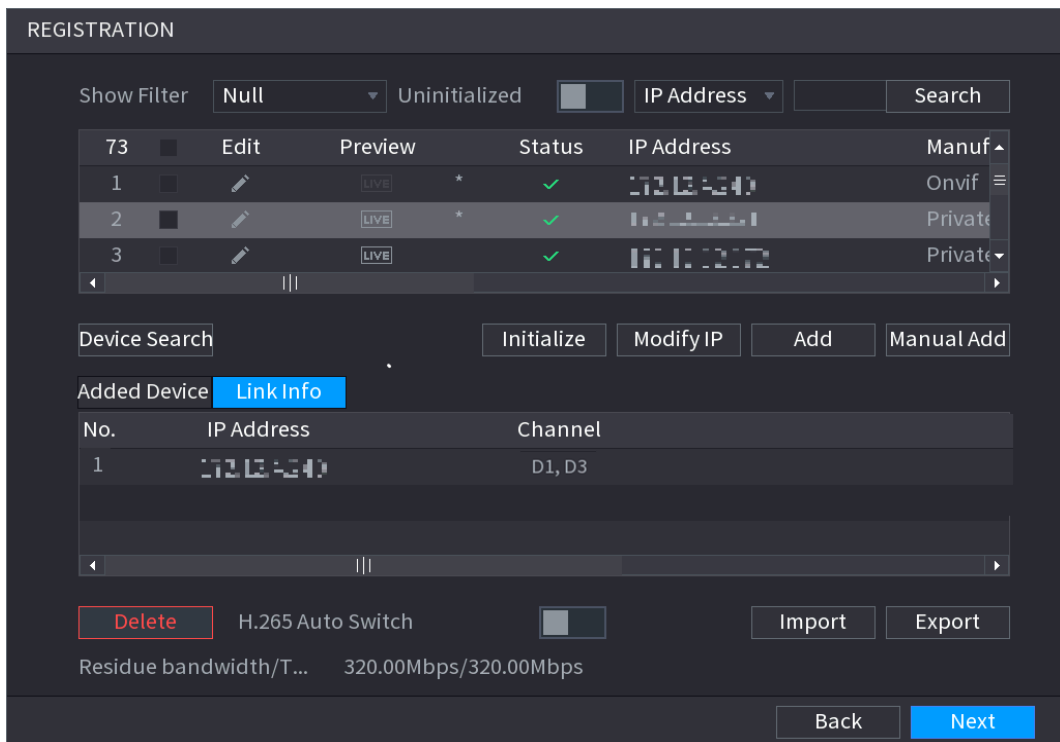

#### 4.1.4.5 RAID Manager

RAID (redundant array of independent disks) is a data storage virtualization technology that combines multiple physical HDD components into a single logical unit for the purposes of data redundancy, performance improvement, or both.



RAID function is for some series product only. Slight difference may be found on the user interface.

**Step 1** Select **Main Menu > STORAGE > RAID > RAID**.

The **RAID** interface is displayed. See Figure 4-31.

Figure 4-31

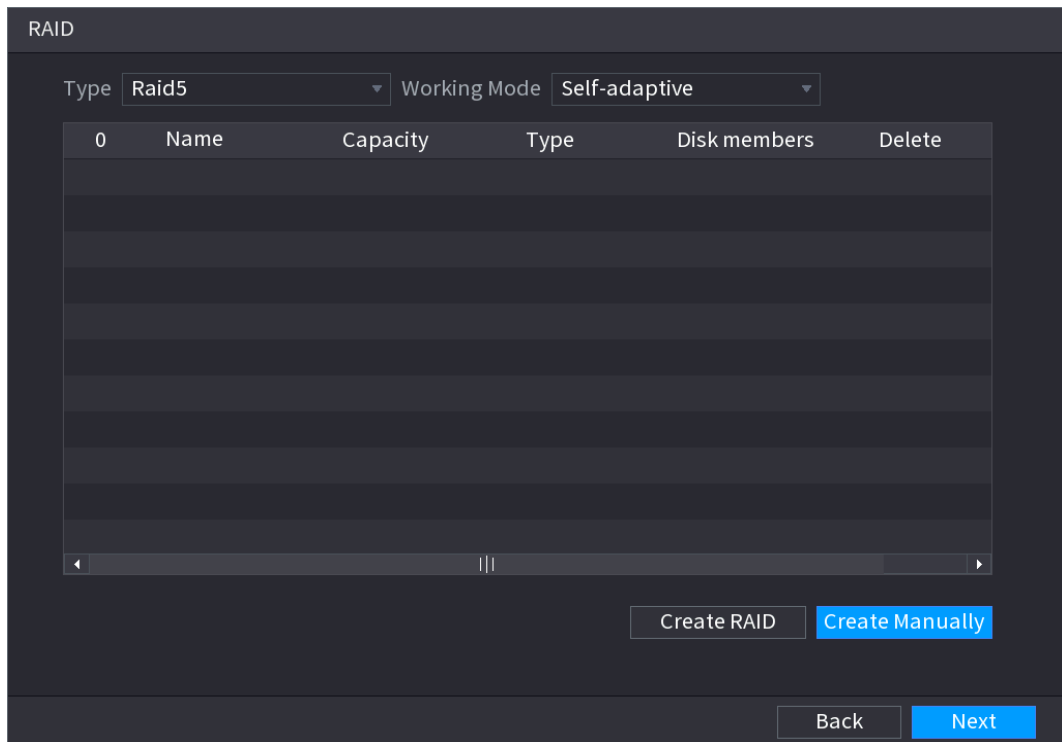

**Step 2** You can click **Create RAID** or **Create Manually**, and all the disks involved will be formatted.

- Click **Create RAID**, the system will create RAID automatically.
  - ◇ If there is no existing RAID and no hot spare disk, the system will create RAID5 and a hot spare disk automatically.
  - ◇ If there is no existing RAID, but existing hot spare disk, the system will only create RAID5 and use the existing hot spare disk automatically.
  - ◇ If there is existing RAID and existing hot spare disk, the system will delete the original RAID and create RAID5 with all the disks and use the existing hot spare disk automatically.
- Click **Create Manually**.
  - 1) Select RAID type and disks as system instructed.
  - 2) Click **Create Manually**, and then the format disk notice is displayed.
  - 3) Click **OK**.

**Step 3** After creating RAID, the disks need to sync with each other to finish the process. For RAID5 and RAID6, you can select different working mode.

- **Self-Adaptive**: Automatically adjust the RAID sync speed according to the business status.
  - ◇ When there is no business running, sync is performed at a high speed.
  - ◇ When there is business running, sync is performed at a low speed.
- **Sync First**: Resource priority is assigned to RAID sync.
- **Business First**: Resource priority is assigned to business operations.
- **Balance**: Resource is evenly distributed to RAID sync and business operations.

#### 4.1.4.6 Schedule

After set record schedule and snapshot schedule, the device can automatically record video and snapshot image at the specified time. Select **Main menu > STORAGE > SCHEDULE**, you can go to the **SCHEDULE** interface.

##### 4.1.4.6.1 Recording Schedule

After set schedule record, device can record video file according to the period you set here. For example, the alarm record period is from 6:00–18:00 Monday, device can record alarm video files during the 6:00–18:00.

All channels are record continuously by default. You can set customized record period and record type.



**Step 1** Click **Next** button.

The **Rec** interface is displayed. See Figure 4-32.

Figure 4-32

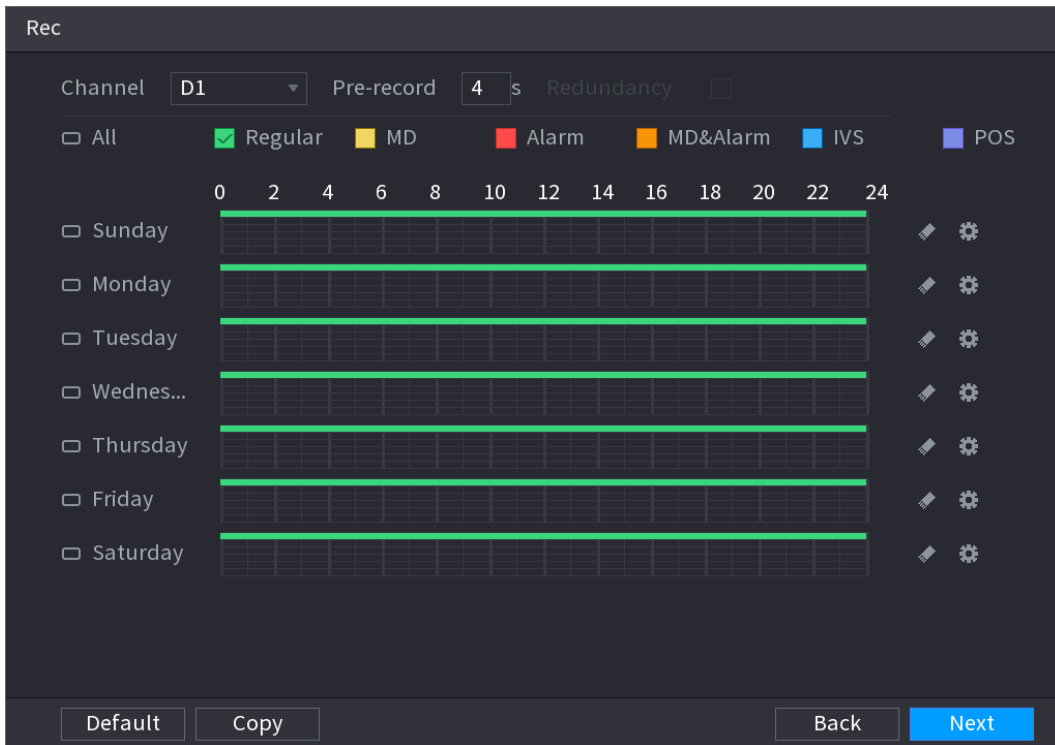

**Step 2** Select a channel from the dropdown list, you can set different record plans for different channels. Select **All** if you want to set for all channels. See Table 4-9.

Table 4-9

Parameter	Description
Channel	In the <b>Channel</b> list, select a channel to record the video.
Pre-record	In the <b>Pre-record</b> list, enter the amount of time that you want to start the recording in advance.
Redundancy	<p>If there are several HDDs installed to the Device, you can set one of the HDDs as the redundant HDD to save the recorded files into different HDDs. In case one of the HDDs is damaged, you can find the backup in the other HDD.</p> <ul style="list-style-type: none"> <li>• Select <b>Main Menu &gt; STORAGE &gt; HDD MANAGER</b>, and then set a HDD as redundant HDD.</li> <li>• Select <b>Main Menu &gt; STORAGE &gt; SCHEDULE &gt; Record</b>, and then select the <b>Redundancy</b> check box.</li> </ul> <p>◇ If the selected channel is not recording, the redundancy function takes effect next time you record no matter you select the check box or not.</p> <p>◇ If the selected channel is recording, the current recorded files will be packed, and then start recording according to the new schedule.</p> <p></p> <ul style="list-style-type: none"> <li>• This function is for some series products only.</li> <li>• The redundant HDD only back up the recorded videos but not snapshots.</li> </ul>
ANR	<p>You can set ANR (auto network resume) function.</p> <ul style="list-style-type: none"> <li>• The IPC continues record once the NVR and IPC connection fails. After the network becomes normal, the NVR can download record file during the offline period from the IPC. It is to guarantee</li> </ul>



Parameter	Description
	<p>there is no record loss on current connected IPC channel.</p> <ul style="list-style-type: none"> <li>Set the max. record upload period. Once the offline period is longer than the period you set here, IPC can only upload the record file during the specified period.</li> </ul> <p> This function is for IPC that installed SD card and the record function is enabled.</p>
Period	<p>Define a period during which the configured recording setting is active. See Figure 4-33.</p> <p> The system only activates the alarm in the defined period.</p>
Copy	Click <b>Copy</b> to copy the settings to other channels.

Figure 4-33



Step 3 Set record type. See Figure 4-34.

Figure 4-34

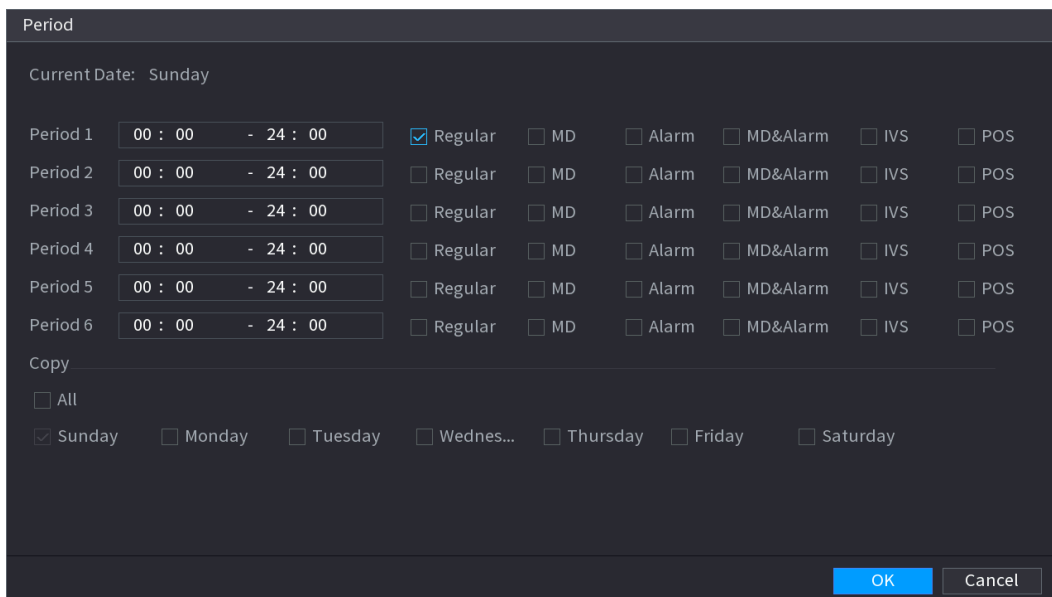
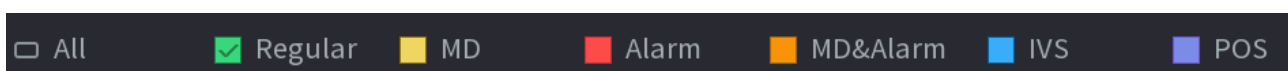

- When the record type is MD (motion detect), alarm, MD&Alarm, IVS and POS, enable the channel record function when corresponding alarm occurs. For example, when the alarm type is MD, select **Main Menu > ALARM > VIDEO DETECTION > Motion Detect**, select the record channel and enable record function. See Figure 4-35.
- When the record type is MD (motion detect), alarm, MD&Alarm, IVS and POS, refer to "4.8.5 Video detect", "4.8.3 Alarm", "4.7.2.4 IVS" and "Step 3 POS" for detailed information.

Figure 4-35

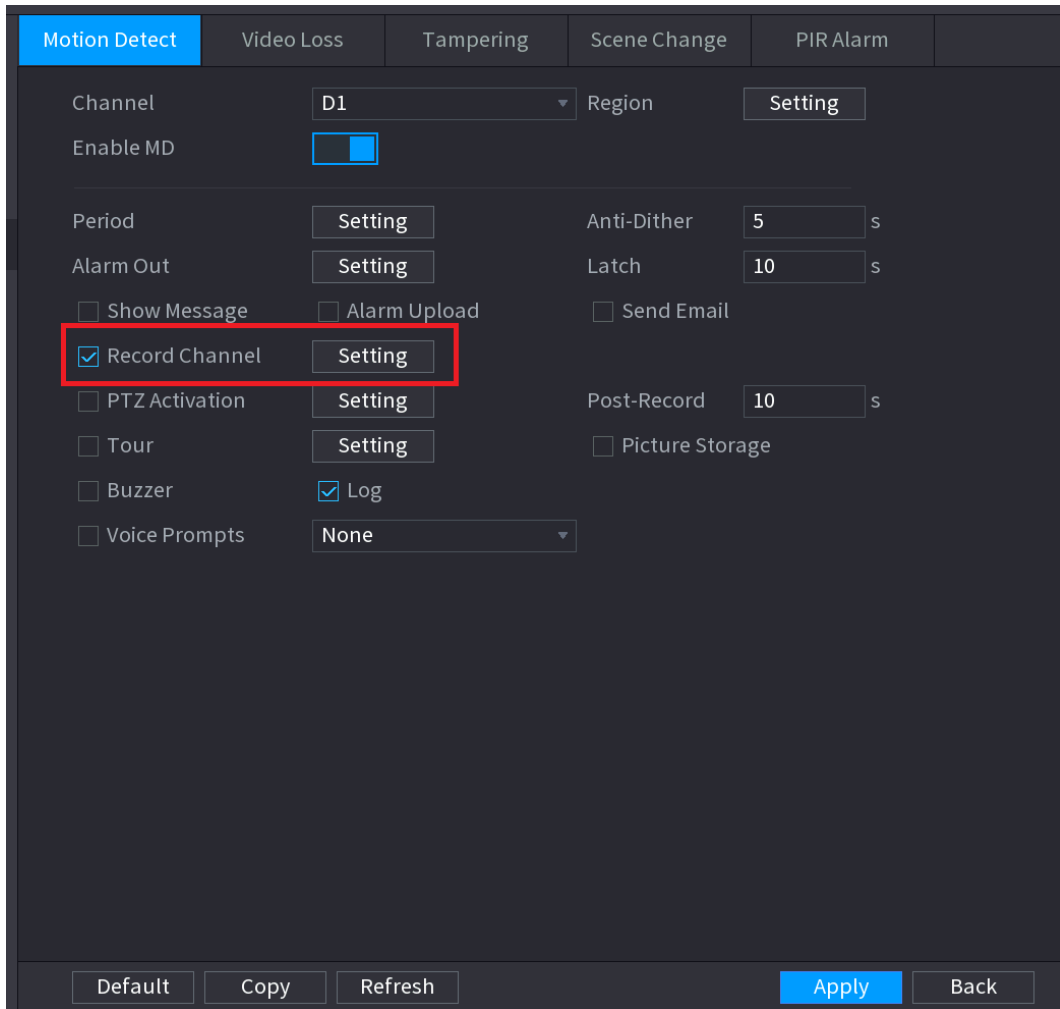



**Step 4** Set record period. It includes edit mode and draw mode. See Figure 4-36.

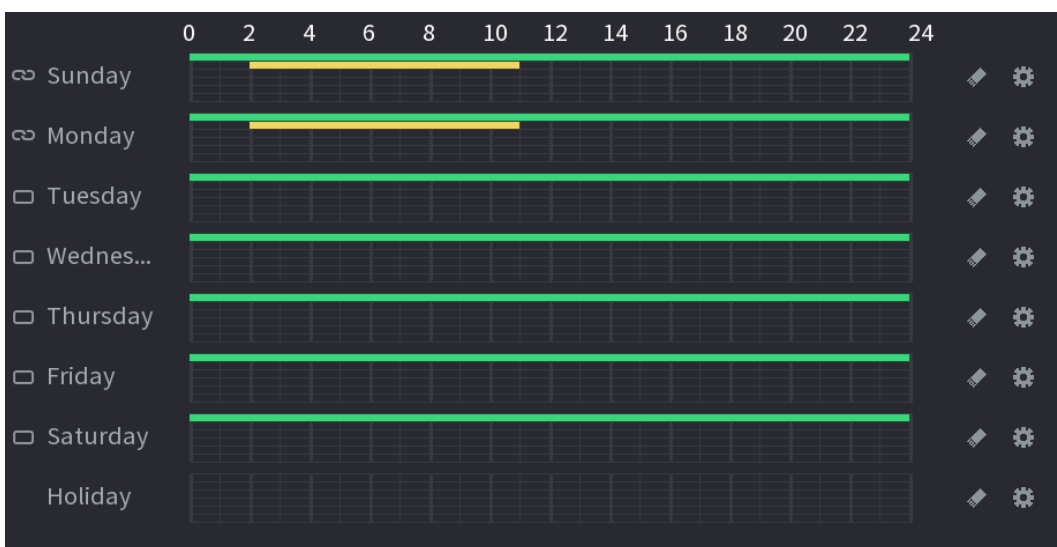

If you have added a holiday, you can set the record period for the holiday.

Figure 4-36



- Define the period by drawing.
  - 1) Select a corresponding date to set.
    - ◇ Define for the whole week: Click  next to **All**, all the icon switches to , you can define the period for all the days simultaneously.



- ◇ Define for several days of a week: Click  before each day one by one, the icon switches to . You can define the period for the selected days simultaneously.
- 2) On the timeline, left click mouse and then drag to define a period. There are six periods in one day, the Device starts recoding the selected event type in the defined period. In Figure 4-37, the different color bars stand for different record types.
  - ◇ Green stands for general record.
  - ◇ Yellow stands for MD (motion detection) record.
  - ◇ Red stands for alarm record.
  - ◇ Blue stands form intelligent record.
  - ◇ Orange stands for MD&Alarm record.
  - ◇ Purple stands for POS record.
  - ◇ Once the time period overlaps, the record priority: MD&Alarm > Alarm > POS > Intelligent > MD >General.
- ◇ Select a record type and then click the  of the corresponding date to clear the corresponding period.

Figure 4-37



The MD record and alarm record function are both null if you enabled MD&Alarm function.

- Define the period by editing.
  - 1) Select a date and then click . The **Period** interface is displayed. See Figure 4-38.

Figure 4-38

Period	Time Range	General	MD	Alarm	MD&Alarm	Intel	POS
Period 1	00:00 - 24:00	<input checked="" type="checkbox"/>	<input type="checkbox"/>	<input type="checkbox"/>	<input type="checkbox"/>	<input type="checkbox"/>	<input type="checkbox"/>
Period 2	00:00 - 24:00	<input type="checkbox"/>	<input type="checkbox"/>	<input type="checkbox"/>	<input type="checkbox"/>	<input type="checkbox"/>	<input type="checkbox"/>
Period 3	00:00 - 24:00	<input type="checkbox"/>	<input type="checkbox"/>	<input type="checkbox"/>	<input type="checkbox"/>	<input type="checkbox"/>	<input type="checkbox"/>
Period 4	00:00 - 24:00	<input type="checkbox"/>	<input type="checkbox"/>	<input type="checkbox"/>	<input type="checkbox"/>	<input type="checkbox"/>	<input type="checkbox"/>
Period 5	00:00 - 24:00	<input type="checkbox"/>	<input type="checkbox"/>	<input type="checkbox"/>	<input type="checkbox"/>	<input type="checkbox"/>	<input type="checkbox"/>
Period 6	00:00 - 24:00	<input type="checkbox"/>	<input type="checkbox"/>	<input type="checkbox"/>	<input type="checkbox"/>	<input type="checkbox"/>	<input type="checkbox"/>

Copy

All

Sunday  Monday  Tuesday  Wednesday  Thursday  Friday  Saturday

Apply Cancel

2) Set record type for each period.

- ◇ There are six periods for you to set for each day.

- ◇ Under **Copy**, select **All** to apply the settings to all the days of a week, or select specific day(s) that you want to apply the settings to.

3) Click **Apply** to save the settings.

**Step 5** Click Apply to complete the settings.



Enable auto record function so that the record plan can become activated. Refer to "4.1.4.6.3 Record control" for detailed information.

#### 4.1.4.6.2 Snapshot Schedule

You can set schedule snapshot period.

After set schedule snapshot, device can snapshot image according to the period you set here. For example, the alarm snapshot period is from 6:00–18:00 Monday, device can snapshot during the 6:00–18:00 when an alarm occurs.

**Step 1** Click Snapshot button, device goes to following interface. See Figure 4-39.



Select **Main Menu > STORAGE > SCHEDULE > Snapshot**, you can go to the snapshot interface.

Figure 4-39

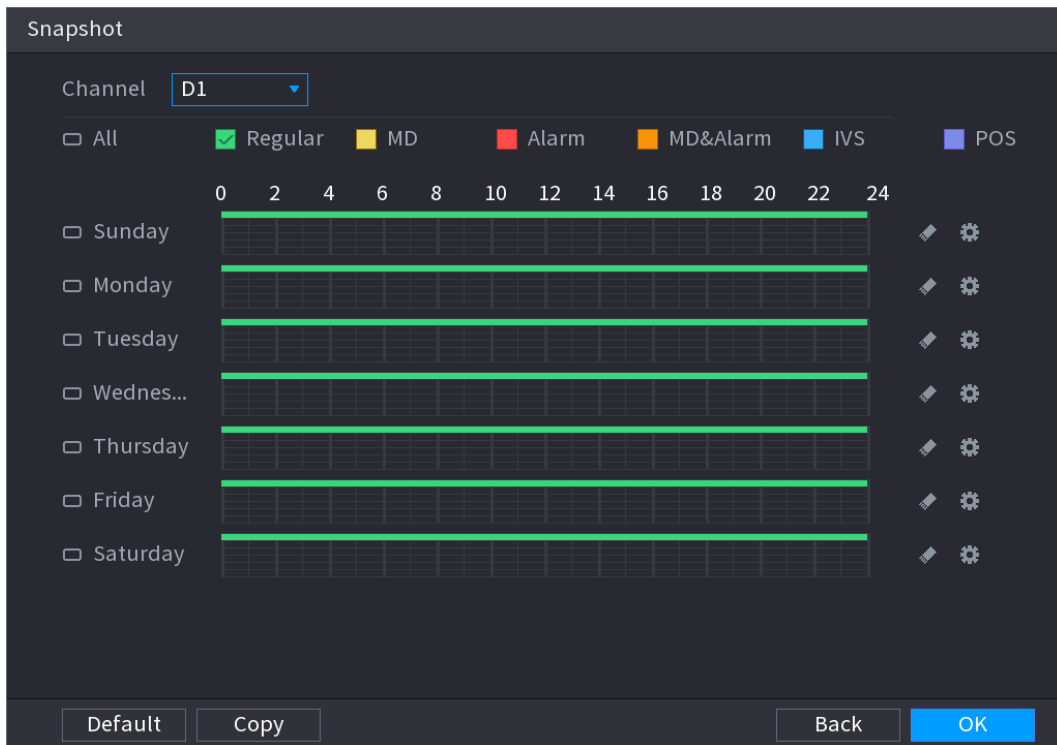

Step 2 Select a channel to set schedule snapshot.

Step 3 Set snapshot type as schedule. Refer to "4.2.5.2 Snapshot" for detailed information.

Step 4 Check the box to set alarm type. See Figure 4-40.

Figure 4-40

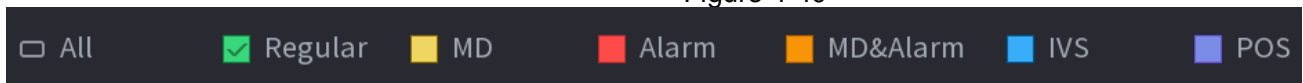

-  When the record type is MD (motion detect), alarm, MD&Alarm, IVS and POS, enable the channel record function when corresponding alarm occurs. For example, when the alarm type is MD, select **Main Menu > ALARM > VIDEO DETECTION > Motion Detect**, select the record channel and enable record function. See Figure 4-35.
- When the record type is MD (motion detect), alarm, MD&Alarm, IVS and POS, refer to "4.8.5 Video detect ", "4.8.3 Alarm ", " 4.7.2.4 IVS " and " Step 3 POS " for detailed information.

Figure 4-41



**Step 5** Refer to "4.1.4.6.1 Record" to set snapshot period.

**Step 6** Click **Apply** button to save snapshot plan.

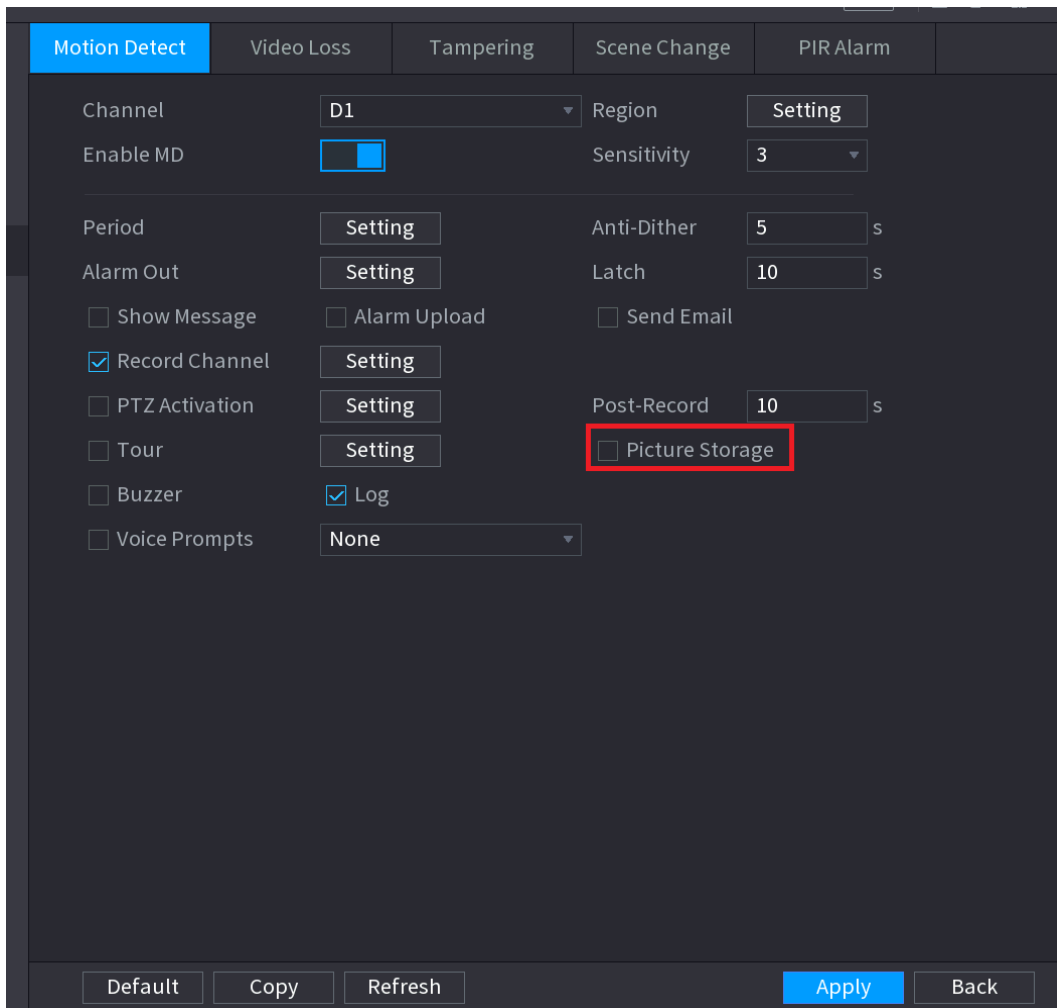

Enable auto snapshot function so that the snapshot plan can become activated. Refer to "4.1.4.6.3 Record control" for detailed information.

#### 4.1.4.6.3 Record Control

After set schedule record or schedule snapshot, you need to enable auto record and snapshot function so that system can automatically record or snapshot.

- Auto: System automatically records at the type and record period you set in Schedule interface.
- Manual: System records general files for all day.



You need to have storage authorities to implement the Manual record operation. Make sure the HDD has been properly installed.

**Step 1** Right click mouse and then select **Manual > Record** or select **Main Menu > STORAGE > RECORD..**



For some series products, after you logged in, you can click the Rec button at the front panel to go to the **Record** interface.

Figure 4-42

Parameter	All	1	2	3	4	5	6
Main Stream	<input type="radio"/>	<input checked="" type="radio"/>	<input checked="" type="radio"/>	<input checked="" type="radio"/>	<input checked="" type="radio"/>	<input checked="" type="radio"/>	<input checked="" type="radio"/>
Auto	<input type="radio"/>	<input checked="" type="radio"/>	<input checked="" type="radio"/>	<input checked="" type="radio"/>	<input checked="" type="radio"/>	<input checked="" type="radio"/>	<input checked="" type="radio"/>
Manual	<input type="radio"/>	<input type="radio"/>	<input type="radio"/>	<input type="radio"/>	<input type="radio"/>	<input type="radio"/>	<input type="radio"/>
Off	<input type="radio"/>	<input type="radio"/>	<input type="radio"/>	<input type="radio"/>	<input type="radio"/>	<input type="radio"/>	<input type="radio"/>
Sub Stream1							
Auto	<input type="radio"/>	<input type="radio"/>	<input type="radio"/>	<input type="radio"/>	<input type="radio"/>	<input type="radio"/>	<input type="radio"/>
Manual	<input type="radio"/>	<input type="radio"/>	<input type="radio"/>	<input type="radio"/>	<input type="radio"/>	<input type="radio"/>	<input type="radio"/>
Off	<input type="radio"/>	<input checked="" type="radio"/>	<input checked="" type="radio"/>	<input checked="" type="radio"/>	<input checked="" type="radio"/>	<input checked="" type="radio"/>	<input checked="" type="radio"/>
Sub Stream2							
Auto	<input type="radio"/>	<input type="radio"/>	<input type="radio"/>	<input type="radio"/>	<input type="radio"/>	<input type="radio"/>	<input type="radio"/>
Manual	<input type="radio"/>	<input type="radio"/>	<input type="radio"/>	<input type="radio"/>	<input type="radio"/>	<input type="radio"/>	<input type="radio"/>
Off	<input type="radio"/>	<input checked="" type="radio"/>	<input checked="" type="radio"/>	<input checked="" type="radio"/>	<input checked="" type="radio"/>	<input checked="" type="radio"/>	<input checked="" type="radio"/>
Snapshot							
Enable	<input type="radio"/>	<input type="radio"/>	<input type="radio"/>	<input type="radio"/>	<input type="radio"/>	<input type="radio"/>	<input type="radio"/>
Disable	<input type="radio"/>	<input checked="" type="radio"/>	<input checked="" type="radio"/>	<input checked="" type="radio"/>	<input checked="" type="radio"/>	<input checked="" type="radio"/>	<input checked="" type="radio"/>

Step 2 Configure parameters.

Parameter	Description
Channel	Displays all the analog channels and the connected digital channels. You can select a single channel or select <b>All</b> .
Record status	<ul style="list-style-type: none"> <li>● <b>Auto</b>: Automatically record according to the record type and recording time as configured in the recording schedule.</li> <li>● <b>Manual</b>: Keep general recording for 24 hours for the selected channel.</li> <li>● <b>Off</b>: Do not record.</li> </ul>
Snapshot status	Enable or disable the scheduled snapshot for the corresponding channels.

Step 3 Click **Apply**.

## 4.2 Camera

### 4.2.1.1 Connection

Select **Main menu > REGISTRATION > Camera Registration**, you can register the remote device. See Figure 4-43.

After register the remote device to the NVR, you can view the video on the NVR, and manage and storage the video file. Different series products support different remote device amount.



Figure 4-43

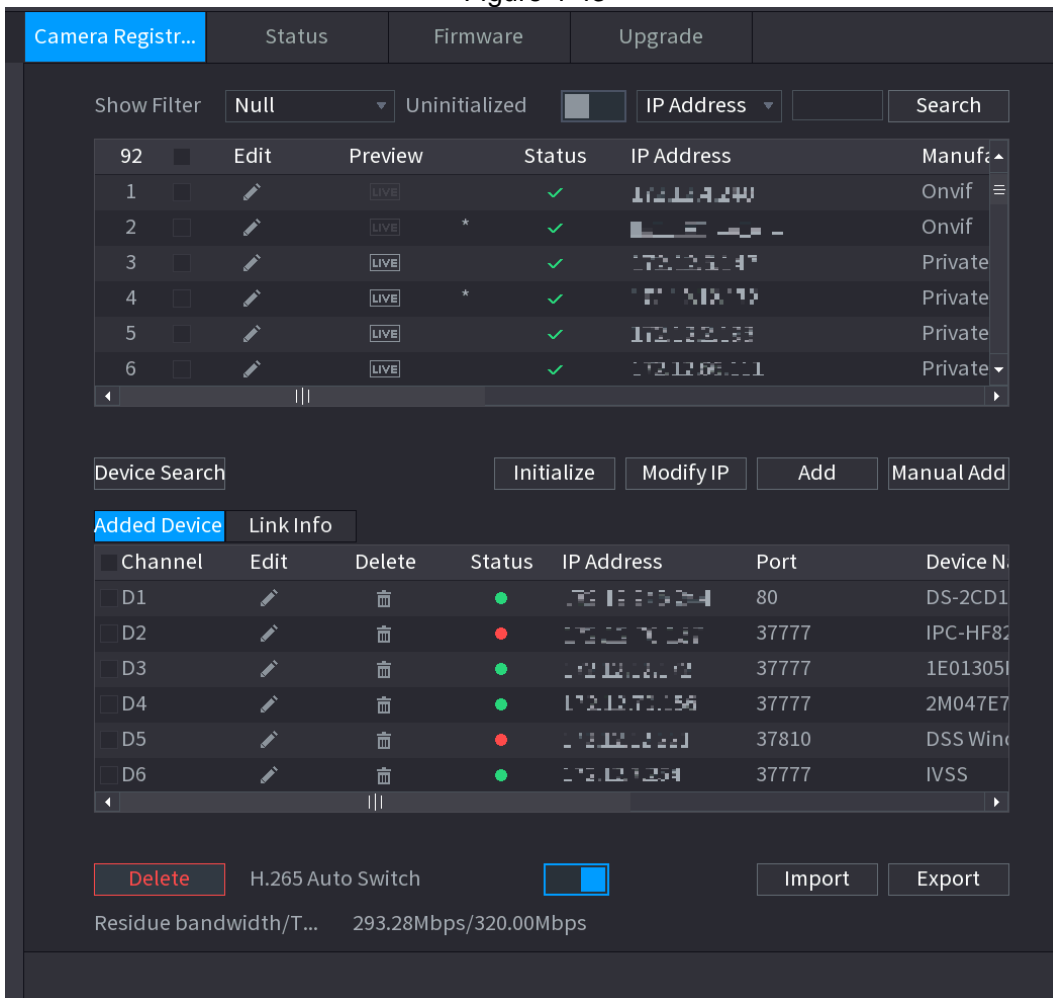

#### 4.2.1.2 Changing IP address

**Step 1** Select **Main Menu > REGISTRATION > Camera Registration**, check the box before

the camera name and then click **Modify IP** or click the  before the camera name. Enter **Modify IP** interface. See Figure 4-44.



Check the box before several cameras, change the IP addresses of several cameras at the same time.

Figure 4-44

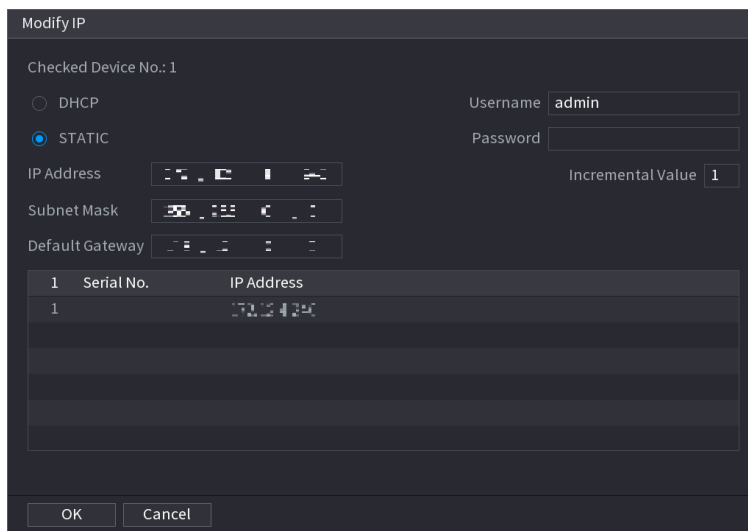

**Step 2** Select IP mode.

- Check **DHCP**, there is no need to input IP address, subnet mask, and default gateway. Device automatically allocates the IP address to the camera.
- Check **Static**, and then input IP address, subnet mask, default gateway and incremental value.



- If it is to change several devices IP addresses at the same time, input incremental value. Device can add the fourth address of the IP address one by one to automatically allocate the IP addresses.
- If there is IP conflict when changing static IP address, device pops up IP conflict dialogue box. If batch change IP address, device automatically skips the conflicted IP and begin the allocation according to the incremental value

**Step 3** Input remote device user name and password.



When change IP addresses of several devices at the same time, make sure the cameras user name and passwords are the same.

**Step 4** Click **OK** button to save settings.

After the modification and then search again, device displays new IP address.

## Auto Changing H.265

For the remote device that first registered to the system, it can automatically adopts encode format as H.265 if you enable H.265 Auto switch function.

Click H.265 Auto Switch button at the bottom of the interface, it is from  to



. The function is enabled. See Figure 4-45.

Figure 4-45

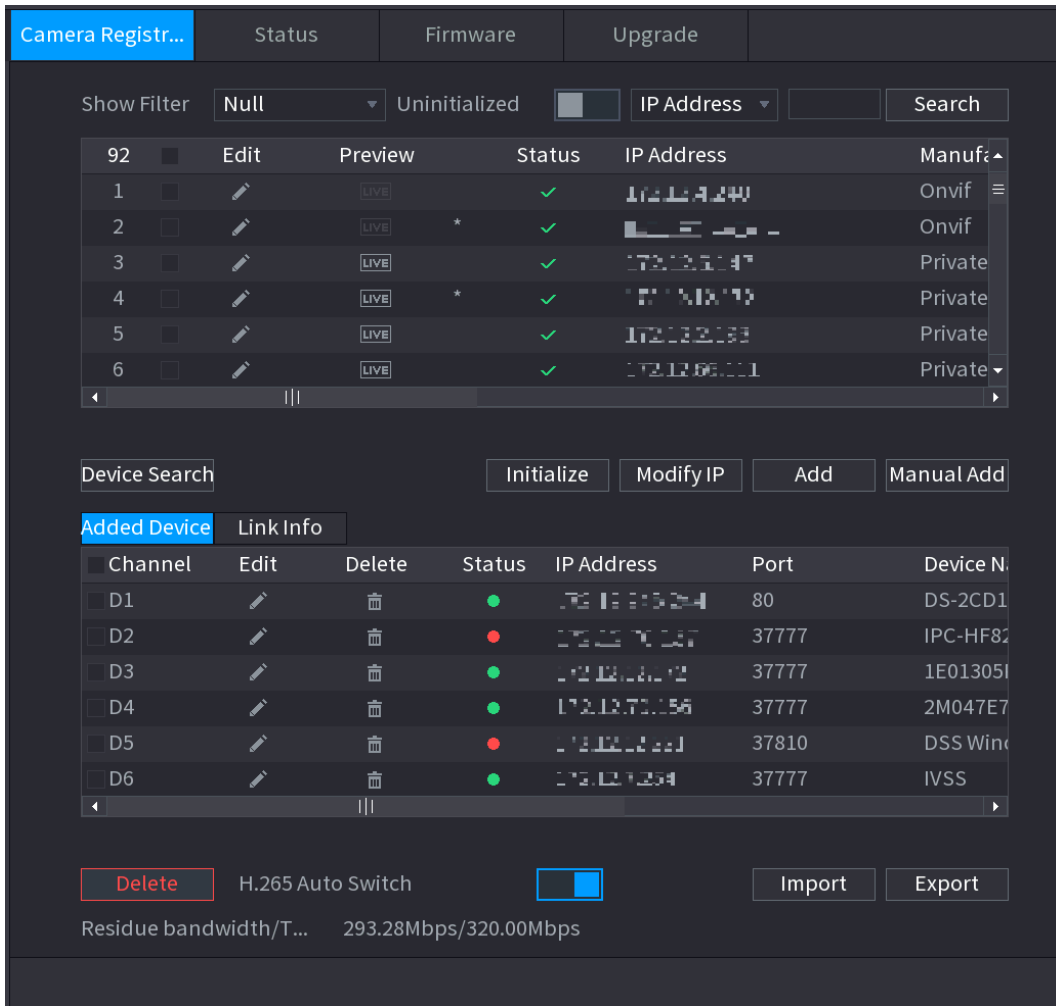

### 4.2.1.3 IP Export

Device can export the Added device list to your local USB device.

- Step 1** Insert the USB device and then click the **Export** button.  
The **Browse** interface is displayed. See Figure 4-46.

Figure 4-46

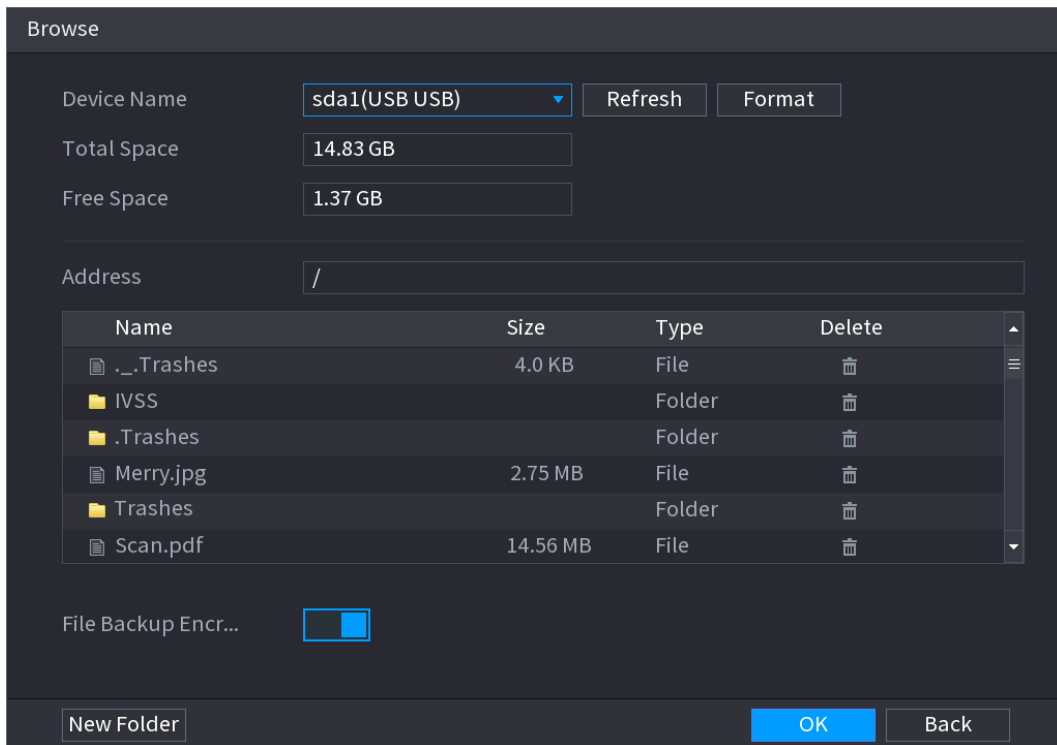

**Step 2** Select **Address** to save export file.

**Step 3** Click the **OK** button.

Device pops up a dialogue box to remind you successfully exported.



When exporting IP address, the **File Backup Encryption** check box is checked by default. The file information includes IP address, port, channel number, manufacturer, user name, and password.

- If you select the File Backup Encryption check box, the file format is .backup.
- If you clear the File Backup Encryption check box, the file format is .csv. In this case, there might be a risk of data leakage.

#### 4.2.1.4 IP Import

**Step 1** Click **Import** button.

The **Browse** interface is displayed. See Figure 4-47.

Figure 4-47

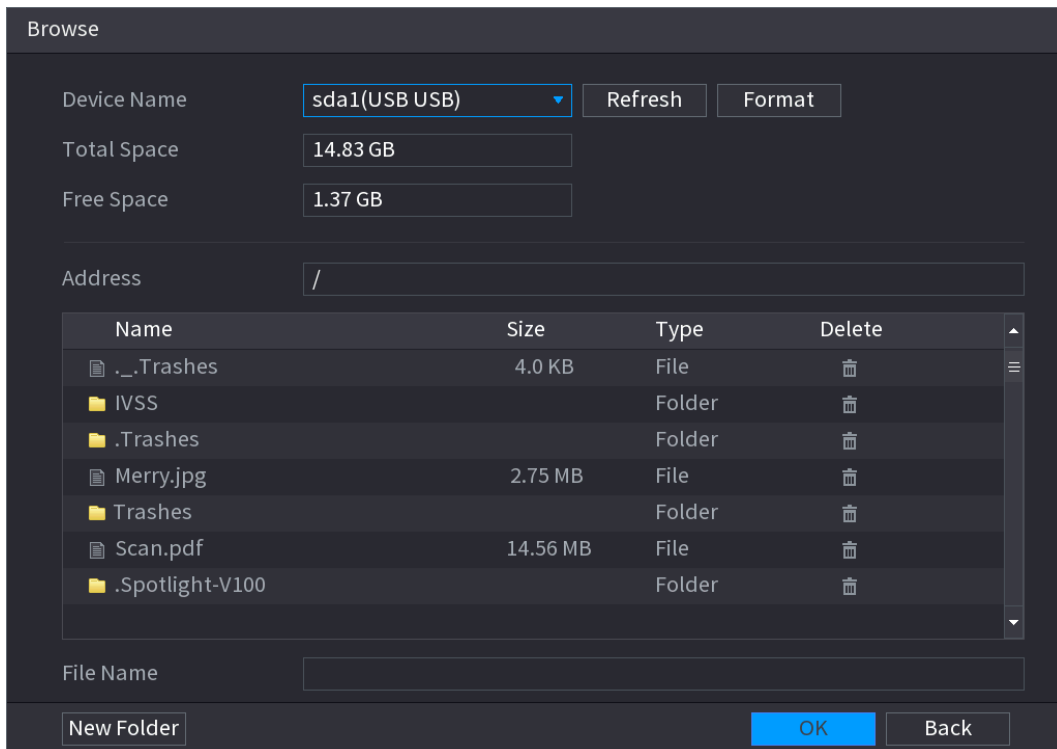

**Step 2** Go to **Address** to select the import file and then click the **OK** button. System pops up a dialogue box to remind you successfully imported.



If the imported IP has conflicted with current added device, system pops up a dialogue box to remind you. You have two options.

**Step 3** Click **OK** button.

The imported information is on the **Added Device** list.

## 4.2.2 Remote Device Initialization

Remote device initialization can change remote device login password and IP address.



- When connect a camera to the NVR via PoE port, NVR automatically initialize the camera. The camera adopts NVR current password and email information by default.
- When connect a camera to the NVR via PoE port after NVR upgraded to the new version, the NVR may fail to initialize the camera. Go to the Registration interface to initialize the camera.

**Step 1** Select **Main Menu > CAMERA > Camera Registration**.

The **Camera Registration** interface is displayed.

**Step 2** Click **Device Search** and then click **Uninitialized**.

Device displays camera(s) to be initialized.

**Step 3** Select a camera to be initialized and then click **Initialize**.

The **Enter Password** interface is displayed. See Figure 4-48.

Figure 4-48

The screenshot shows a dark-themed window titled "Enter Password". At the top, there is a header bar with the text "Enter Password". Below the header, there is a single checkbox labeled "Using current device password and email info." which is checked. At the bottom right of the window, there is a "Next" button.

**Step 4** Set remote device password and email information.



If you want to use current device password and email information, the remote device automatically uses NVR admin account information (login password and email). There is no need to set password and email. Go to step 6.

- 1) Cancel **Using current device password and email info**,  
The **Enter Password** interface is displayed. See Figure 4-49.

Figure 4-49

The screenshot shows a dark-themed window titled "Enter Password". At the top, there is a header bar with the text "Enter Password". Below the header, there is a single checkbox labeled "Using current device password and email info." which is unchecked. Below the checkbox, there are three input fields: "User" with the value "admin", "Password" (empty), and "Confirm Password" (empty). Below the "Password" field, there is a text instruction: "Use a password that has 8 to 32 characters, it can be a combination of letter(s), number(s) and symbol(s) with at least two kinds of them. (please do not use special symbols like ' ; : & )". At the bottom right of the window, there is a "Next" button.

- 2) Configure parameters. See Table 4-10.

Table 4-10

Parameter	Description
User	The default is <b>admin</b> .
Password	The new password can be set from 8 characters through 32 characters and contains at least two types from number, letter and special characters (excluding "", "", ";", ":" and "&").
Confirm Password	Enter a strong password according to the password strength bar indication.



For your device own safety, create a strong password of your own choosing. We also recommend you change your password periodically especially in the high security system.

**Step 5** Click **Next** button.

The **Password Protection** interface is displayed. See Figure 4-50.

Figure 4-50

**Step 6** Set email information.

Input an email address for reset password purpose.



Cancel the box and then click Next or Skip if you do not want to input email information here.

**Step 7** Click **Next** button.

The **Network** interface is displayed. See Figure 4-51.

Figure 4-51

1	Serial No.	IP Address
1		192.168.1.254

**Step 8** Set camera IP address.

- Check **DHCP**, there is no need to input IP address, subnet mask, and default gateway. Device automatically allocates the IP address to the camera.
- Check **Static**, and then input IP address, subnet mask, default gateway and incremental value.



- If it is to change several devices IP addresses at the same time, input incremental value. Device can add the fourth address of the IP address one by one to automatically allocate the IP addresses.
- If there is IP conflict when changing static IP address, device pops up IP conflict dialogue box. If batch change IP address, device automatically skips the conflicted IP and begin the allocation according to the incremental value

**Step 9** Click **Next** button.

The **Device Initialization** interface is displayed. See Figure 4-52.



Figure 4-52

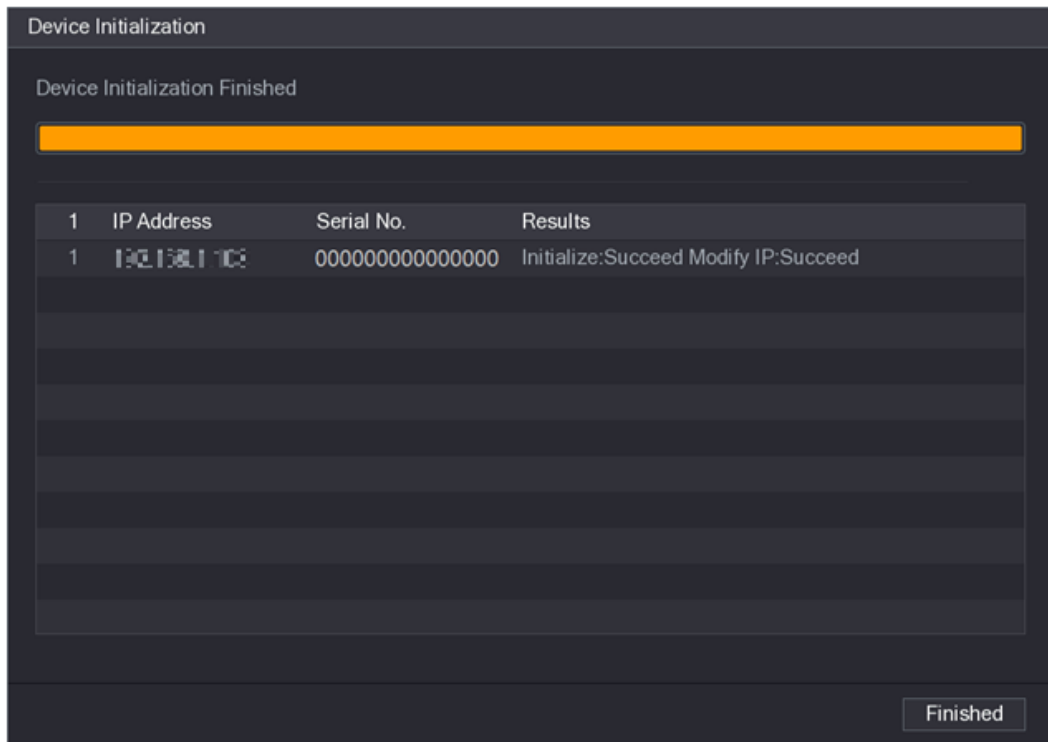

Step 10 Click **Finished** to complete the setup.

### 4.2.3 Short-Cut Menu to Register Camera

If you have not registered a remote device to a channel, go to the preview interface to add.

Step 1 On the Preview interface, Move your mouse to window.

There is an icon "+" on the channel window. See Figure 4-53.

Figure 4-53

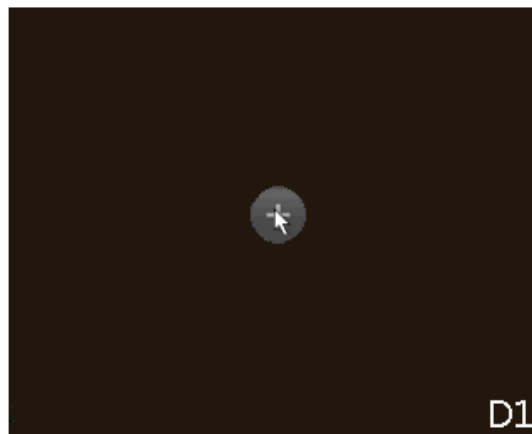

Step 2 Click "+", device pops up interface to add network camera. Refer to "4.1.4.4 Registration" for detailed information.

### 4.2.4 Image

You can set network camera parameters according to different environments. It is to get the best video effect.

Step 1 Select **Main Menu > CAMERA > IMAGE**.

The **IMAGE** interface is displayed. See Figure 4-54.

Figure 4-54

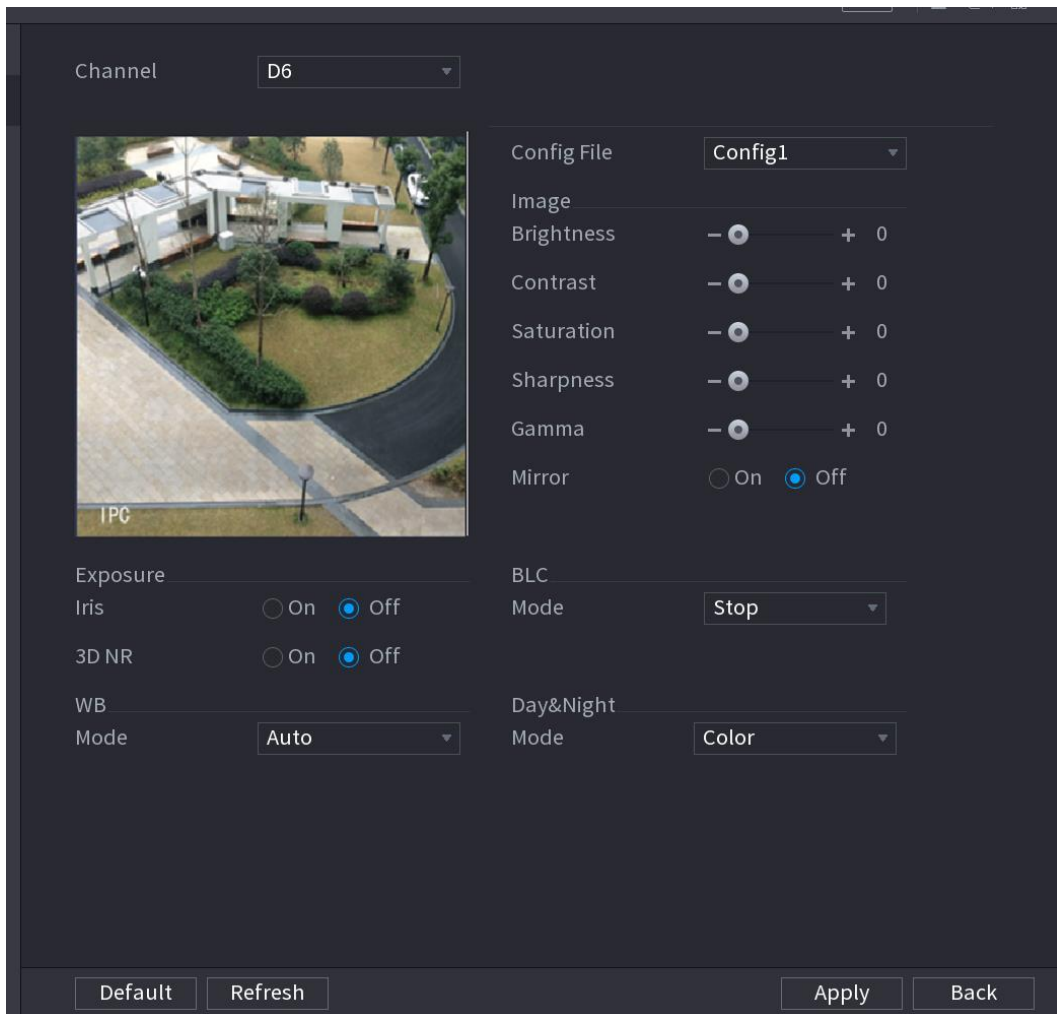



**Step 2** Configure parameters. See Table 4-11.



Different series network camera displays different parameters. The actual product shall prevail.

Table 4-11

Parameter	Description
Channel	In the <b>Channel</b> list, select the channel that you want to configure.
Config File	There are three config files for you. System has configured the corresponding parameters for each file, you can select according to your actual situation.
Brightness	Adjusts the image brightness. The bigger the value is, the brighter the image will become. Adjusts the brightness according to actual environment.
Contrast	Adjusts the image contrast. The bigger the value is, the more obvious the contrast between the light area and dark area will become. Adjusts the contrast according to actual environment.
Saturation	Adjusts the color shades. The bigger the value, the lighter the color will become. Adjusts the saturation according to actual environment.
Sharpness	Adjusts the sharpness of image edge. The bigger the value is, the more obvious the image edge is. Adjusts the sharpness according to actual environment.
Gamma	It is to adjust image brightness and enhance the image dynamic display range. The bigger the value is, the more bright the video is.

Parameter	Description
Mirror	Enable the function, the left and right side of the video image will be switched. It is disabled by default.  This function is for some series products only.
Field of view	It is to set monitor video display direction. It includes normal, reflection, lobby 1, lobby 2.
Exposure	<ul style="list-style-type: none"> <li>Auto iris <ul style="list-style-type: none"> <li>It is for the camera of auto iris only.</li> <li>After enable auto iris function, the iris can automatically zoom in/zoom out according to the brightness of the environment and the image brightness changes too.</li> <li>If disable the auto iris function, the iris does not automatically zoom in/zoom out according to the brightness of the environment when the iris is at the biggest value.</li> </ul> </li> </ul>
	<ul style="list-style-type: none"> <li>3D NR <ul style="list-style-type: none"> <li>This function specially applies to the image which frame rate is configured as 2 at least. It reduces the noises by making use of the information between two frames. The bigger the value is, the better the effect.</li> </ul> </li> </ul>
BLC	<p>You can set camera BLC mode.</p> <ul style="list-style-type: none"> <li>Self-adaptive: In the backlight environment, the system can automatically adjust image brightness to clearly display the object.</li> <li>BLC: <ul style="list-style-type: none"> <li>Default: The device auto exposures according to the environments situation so that the darkest area of the video is cleared</li> <li>Customize: After select the specified zone, the system can expose the specific zone so that the zone can reach the proper brightness.</li> </ul> </li> <li>WDR: In backlight environment, it can lower the high bright section and enhance the brightness of the low bright section. So that you can view these two sections clearly at the same time.</li> <li>HLC: In the backlight environment, it can lower the brightness of the brightest section and reduce the area of the halo and lower the brightness of the whole video.</li> <li>Stop: It is to disable the BLC function.</li> </ul>
WB	<ul style="list-style-type: none"> <li>You can set camera WB mode. It can affect the image whole hue so that the image can accurately displays the environment status.</li> <li></li> <li>Different cameras supports different WB modes such as auto, manual ,natural light, outdoor and etc.</li> </ul>
Day & Night	<p>Configure the color and black&amp;white mode of the image. This setting is not affected by the configuration files. The default setting is <b>Auto</b>.</p> <ul style="list-style-type: none"> <li>Color: The camera outputs color image only.</li> <li>Auto: Depends on the camera, such as overall brightness and whether there is an IR light, either color image or black&amp;white image is output.</li> <li>B/W: The camera outputs Black and white image only.</li> <li>Sensor: It is to set when there is peripheral connected IR light.</li> <li> The Sensor item is for some non-IR device only.</li> </ul>

Step 3 Click **Apply**.

## 4.2.5 Encode

You can set video bit stream and image parameters.

### 4.2.5.1 Encode

You can set video bit stream parameters such as bit stream type, compression, resolution.



Some series products support three streams: main stream, sub stream 1, sub stream 2. The sub stream maximally supports 1080P.



**Step 1** Select **Main menu > CAMERA > ENCODE > ENCODE**.

The **ENCODE** interface is displayed. See Figure 4-55.

Figure 4-55

**Step 2** Configure parameters. See Table 4-12.

Table 4-12

Parameter	Description
Channel	In the <b>Channel</b> list, select the channel that you want to configure the settings for.
Smart Codec	Enable the smart codec function. This function can reduce the video bit stream for non-important recorded video to maximize the storage space. <ul style="list-style-type: none"> <li>● : Enabled.</li> <li>● : Disabled.</li> </ul>
Type	<ul style="list-style-type: none"> <li>● Main Stream: In the <b>Type</b> list, select <b>General</b>, <b>MD</b> (Motion Detect), or <b>Alarm</b>.</li> <li>● Sub Stream: This setting is not configurable.</li> </ul>
Compression	In the <b>Compression</b> list, select the encode mode. <ul style="list-style-type: none"> <li>● H.265: Main profile encoding. This setting is recommended.</li> <li>● H.264H: High profile encoding. Low bit stream with high definition.</li> <li>● H.264: Main profile encoding.</li> </ul>

Parameter	Description
	<ul style="list-style-type: none"> <li>H.264B: Baseline profile encoding. This setting requires higher bit stream compared with other settings for the same definition.</li> </ul>
Resolution	In the Resolution list, select resolution for the video. The maximum video resolution might be different dependent on your device model.
Frame Rate (FPS)	Configure the frames per second for the video. The higher the value is, the clearer and smoother the image will become. Frame rate changes along with the resolution. Generally, in PAL format, you can select the value from 1 through 25; in NTSC format, you can select the value from 1 through 30. However, the actual range of frame rate that you can select depends on the capability of the Device.
Bit Rate Type	In the <b>Bit Rate Type</b> list, select <b>CBR</b> (Constant Bit Rate) or <b>VBR</b> (Variable Bit Rate). If you select <b>CBR</b> , the image quality cannot be configured; if you select <b>VBR</b> , the image quality can be configured.
Quality	This function is available if you select <b>VBR</b> in the <b>Bit Rate</b> List. The bigger the value is, the better the image will become.
I Frame Interval	The interval between two reference frames.
Bit Rate (Kb/S)	In the <b>Bit Rate</b> list, select a value or enter a customized value to change the image quality. The bigger the value is, the better the image will become.

**Step 3** Click **More Setting**.

The **More Setting** interface is displayed. See Figure 4-56.

Figure 4-56

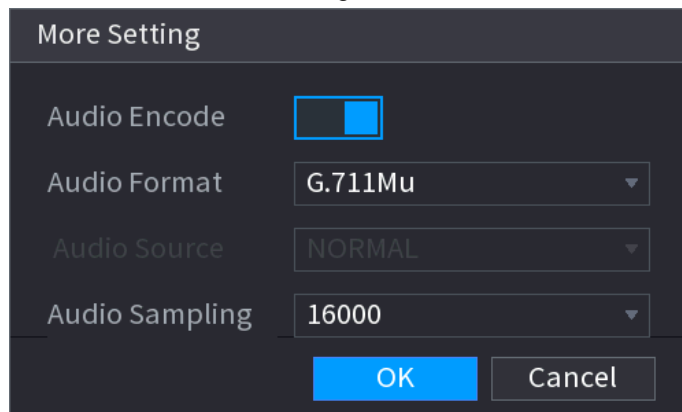

**Step 4** Configure parameters. See Table 4-13.

Table 4-13

Parameter	Description
Audio Encode	<ul style="list-style-type: none"> <li>This function is enabled by default for main stream. You need to manually enable it for sub stream 1. Once this function is enabled, the recorded video file is composite audio and video stream.</li> </ul>
Audio Format	In the <b>Audio Format</b> list, select a format: G711a, G711u, PCM, AAC.
Audio Sampling	<ul style="list-style-type: none"> <li>In the <b>Audio Sampling</b> list, you can select audio sampling rate.</li> </ul>

**Step 5** Click **OK**.

Back to **Encode** interface.

**Step 6** Click **Apply**.

#### 4.2.5.2 Snapshot

You can set snapshot mode, image size, quality and interval.

**Step 1** Select **Main menu > CAMERA > ENCODE > Snapshot**.

The **SNAPSHOT** interface is displayed. See Figure 4-57.

Figure 4-57

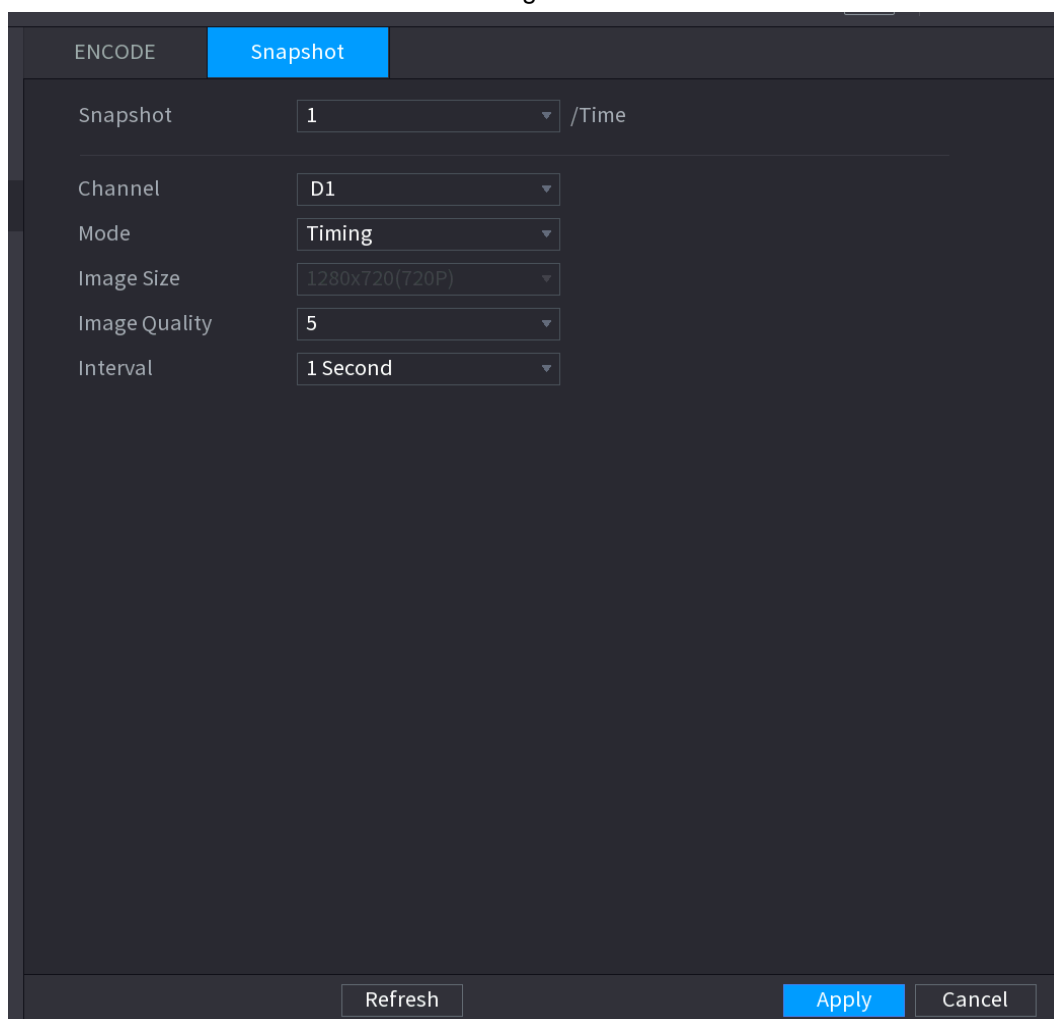

**Step 2** Configure parameters. See Table 4-14.

Table 4-14

Parameter	Description
Manual Snap	In the <b>Manual Snap</b> list, select how many snapshots you want to take each time.
Channel	In the <b>Channel</b> list, select the channel that you want to configure the settings for.
Mode	In the <b>Mode</b> list, you can select <b>Timing</b> , or <b>Trigger</b> . <ul style="list-style-type: none"> <li>• <b>Timing</b>: The snapshot is taken during the scheduled period.</li> <li>• <b>Trigger</b>: The snapshot is taken when there is an alarm event occurs, such as motion detection event, video loss, and local alarms.</li> </ul>
Image Size	<ul style="list-style-type: none"> <li>• In the <b>Image Size</b> list, select a value for the image. The bigger the value is, the better the image will become.</li> </ul>
Image Quality	Configure the image quality by 6 levels. The higher the level is, the better the image will become.
Interval	Configure or customize the snapshot frequency. Max. supports 3600 seconds/image.

**Step 3** Click **Apply**.

## 4.2.6 Channel Name

You can set customized channel name.

**Step 1** Select **Main Menu > CAMERA > CAM NAME**.

The **CAM NAME** interface is displayed. See Figure 4-58.

Figure 4-58

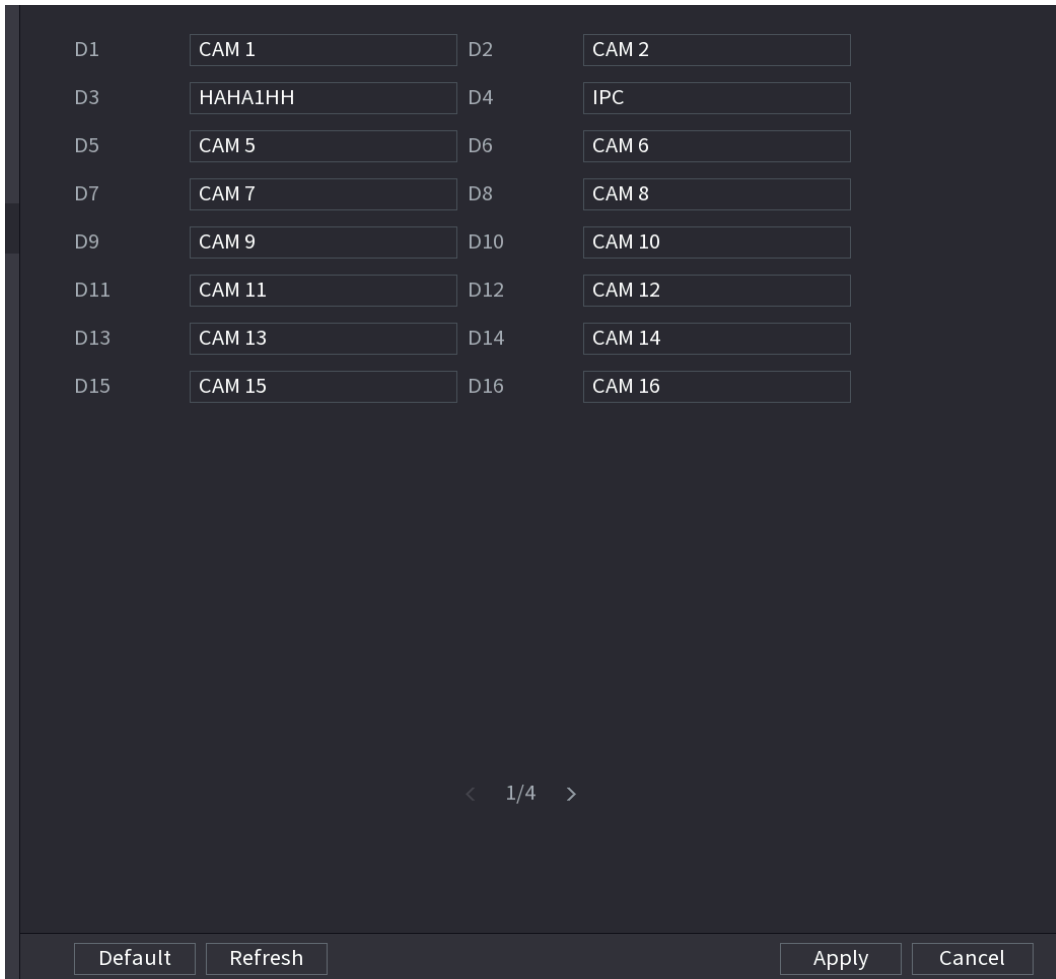

**Step 2** Modify a channel name.



- You can only change the camera connected via the private protocol.
- The channel name supports 63 English characters.

**Step 3** Click **Apply**.

## 4.2.7 Remote Upgrade

You can upgrade the connected network camera firmware. It includes online upgrade and file upgrade.

**Step 1** Select **Main Menu > CAMERA > REGISTRATION > Upgrade**.  
The **Upgrade** interface is displayed. See Figure 4-59.

Figure 4-59

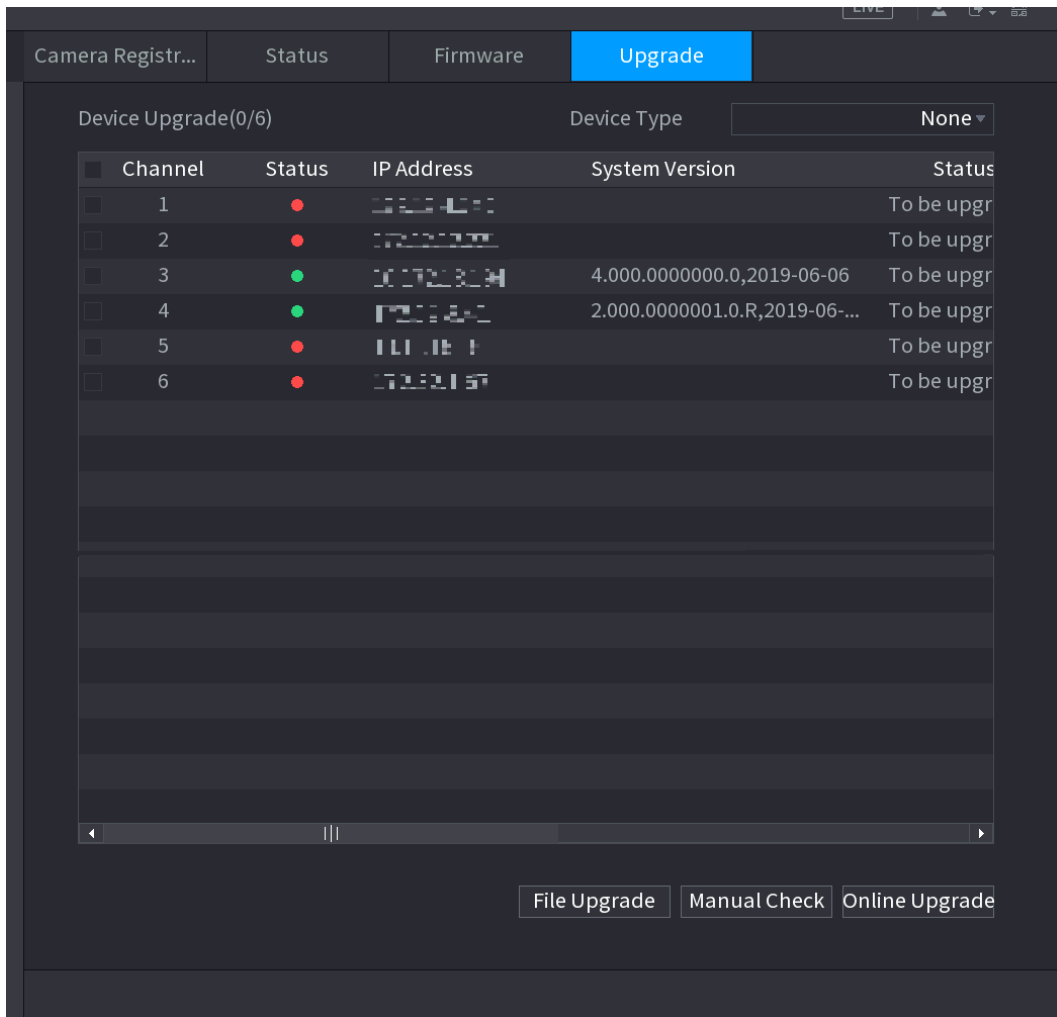

**Step 2** Update the firmware of the connected remote device.

- Online Upgrade
  - 1) Select a remote device and then click the **Detect** button on the right side, or check a box to select a remote device and then click **Manual Check**. System detects the new version on the cloud.
  - 2) Select a remote device that has new version and then click online upgrade. After successful operation, system pops up upgrade successful dialogue box.
- File upgrade
  - 1) Select a channel and then click **File Upgrade**.
  - 2) Select upgrade file on the pop-up interface.
  - 3) Select the upgrade file and then click **OK** button. After successful operation, system pops up upgrade successful dialogue box.



If there are too much remote devices, select **Device Type** from the drop-down list to search the remote device you desire.

## 4.2.8 Remote Device Info

### 4.2.8.1 Device Status

You can view the connection and alarm status of the corresponding channel.

Select **Main Menu > CAMERA > REGISTRATION > Status**, the **Status** interface is displayed. See Figure 4-60. Refer to Table 4-15 for detailed information.



Figure 4-60

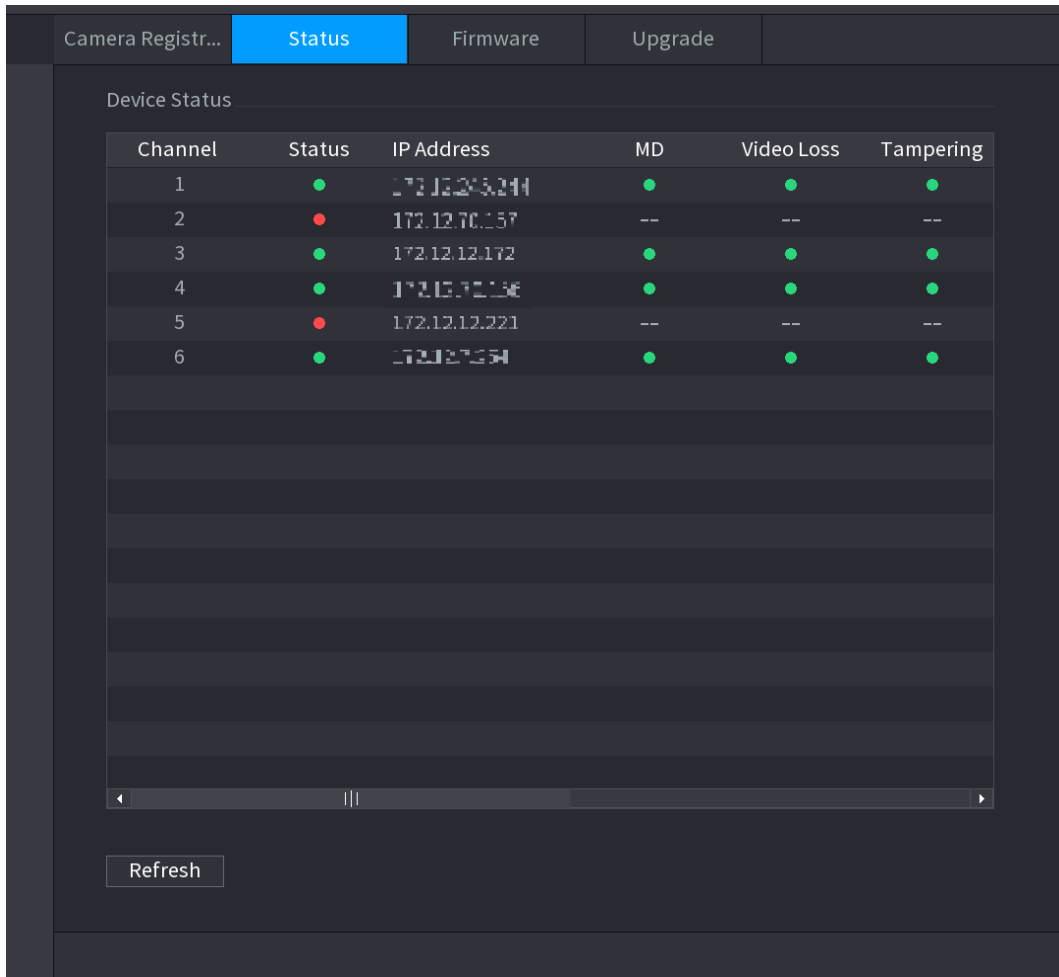

Table 4-15

Icon	Description	Icon	Description
	IPC works properly.		IPC does not support.
	There is an alarm.		Video loss occurs.

#### 4.2.8.2 Firmware

You can view IP address, manufacturer, type, system version of the connected remote device.

Select **Main Menu > CAMERA > REGISTRATION > Firmware**, the **Firmware** interface is displayed. See Figure 4-61.

Figure 4-61

Channel	IP Address	Manufacturer	Type	System Version
1	172.12.243.244	Onvif	D5-2CD1225-I3	
2	172.12.70.157	Private		
3	172.12.12.172	Private	IPC-HF833UE-I	2.430.0000.000,2015
4	172.12.70.156	Private	IPC-HF833UE-I	2.420.0013.0.T,2017
5	172.12.70.201	Private		
6	172.12.7.254	Private	CH-WS8724	2.300.000001.0.R.2

Refresh

### 4.3 Live View





After you logged in, the system goes to multiple-channel live view mode by default. You can view the monitor video of each channel.

The displayed window amount may vary. The actual product shall prevail.

#### 4.3.1 Preview

On Preview interface, you can view the monitor video of each channel. The corresponding channel displays date, time, and channel name after you overlay the corresponding information. Refer to the following table for detailed information. See Table 4-16.

Table 4-16

No.	Icon	Description
1		When current channel is recording, system displays this icon.
2		When motion detection alarm occurs, system displays this icon.
3		When video loss alarm occurs, system displays this icon.
4		When current channel is in monitor lock status, system displays this icon.
5		When the device connects to the network camera remotely, system displays this icon.

No.	Icon	Description
		This function is for some series products only.

### 4.3.2 Navigation bar

You can quickly perform operation through the icon on the navigation bar.



- Different series products may display different navigation bar icons. Refer to the actual product for detailed information.
- Select **Main Menu > SYSTEM > GENERAL > General** to enable navigation bar function and then click **Apply**; otherwise you cannot see the following interface.

















Step 1 On the preview interface, left click mouse,



You can see navigation bar. See Figure 4-62. Refer to Table 4-17 to view detailed information.

Figure 4-62



Table 4-17

Icon	Function
	Open <b>Main Menu</b> .
	Expand or condense the navigation bar.
	Select view layout.
	Go to the previous screen.
	Go to the next screen.
	Enable tour function. The icon switches to   Close the tour or the triggered tour operation has cancelled, device restores the previous preview video.
	Open the <b>PTZ control</b> panel. For details, see "4.4.2 PTZ Control".
	Open the <b>Color Setting</b> interface. For details, see "4.4.2 PTZ Control."  This function is supported only in single-channel layout.
	Open the record search interface. For detail, see "4.6.2 Search Interface."
	Open the <b>Broadcast</b> interface. For detail, see "4.18.3 Broadcast."
	Open the <b>EVENT</b> interface to view the device alarm status. For details, see "4.8.2 Alarm Status."
	Open the <b>CHANNEL INFO</b> interface to display the information of each channel. For details, see " 4.3.2.1 Channel Info."
	Open the <b>CAMERA REGISTRATION</b> interface. For details, see "4.1.4.4 Registration."
	Open the <b>NETWORK</b> interface. For details, see " 4.12 Network."

Icon	Function
	Open the <b>HDD MANAGER</b> interface. For details, see " 4.13.3 HDD."
	Open the <b>USB MANAGER</b> interface. For details about USB operations, see " 4.3.2.2 USB Manager."

#### 4.3.2.1 Channel Info

After the remote device registered to the corresponding channel, you can view its status such as alarm status, record status, connection status, record mode, etc.

- Alarm status: It includes motion detection alarm, video loss alarm, tampering alarm.
- Record status: System is recording or not.
- Bit Rate: System displays bit rate information.
- Status: current channel connection status.

Click button , system goes to the channel information setup interface. You can view information of the corresponding channel. See Figure 4-63.

Figure 4-63



Cha...	Motion De...	Video ...	Tampering	Record St...	Bit Rate(...	Status	Record ...
D1	--	--	--	--	4147	●	Pre-record
D2	--	--	--	--	0	●	Pre-record
D3	--	--	--	--	1712	●	Pre-record
D4	--	--	--	--	7808	●	Pre-record
D5	--	--	--	--	0	●	Pre-record
D6	--	--	--	--	0	●	Pre-record

Refresh

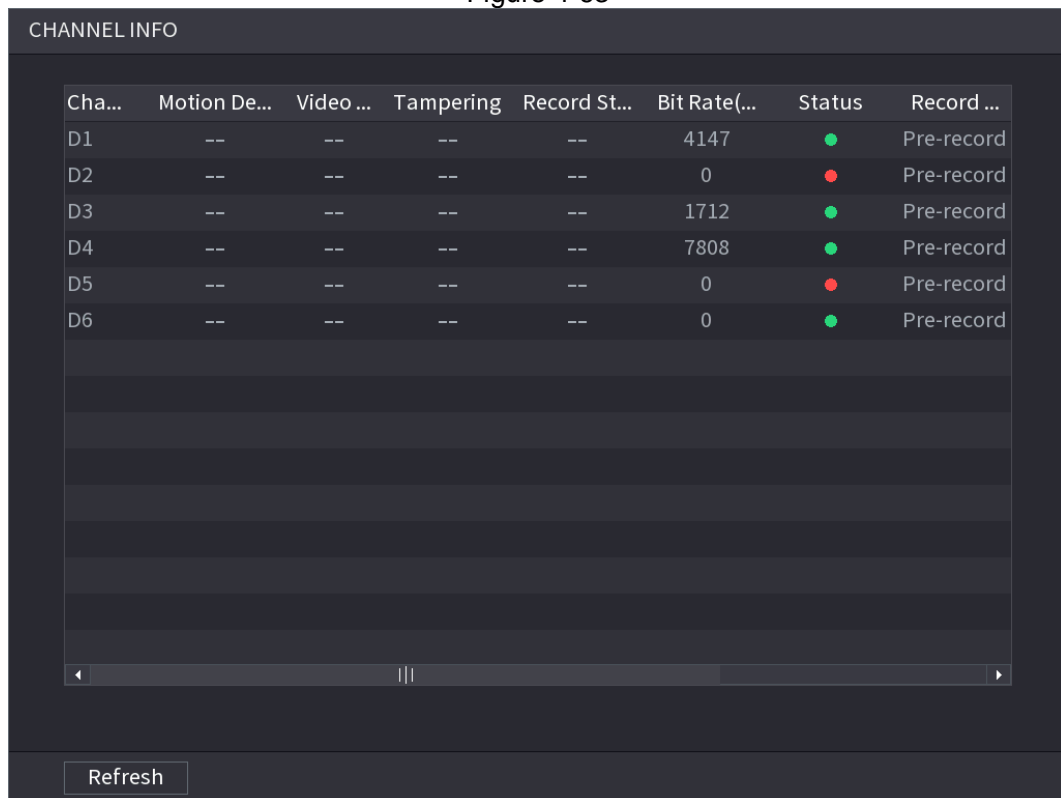
#### 4.3.2.2 USB Manager

After connecting the USB device, you can copy log, config file to USB device or update NVR system.

Click , system goes to HDD Manager interface. You can view and manage HDD information. See Figure 4-64.

Here you can view USB information, backup file, and update system. Refer to "4.11 File Backup", "4.10.1 Log", "4.10.4.2 IMP/EXP", "4.10.4.4 System Update" for detailed information.

Figure 4-64

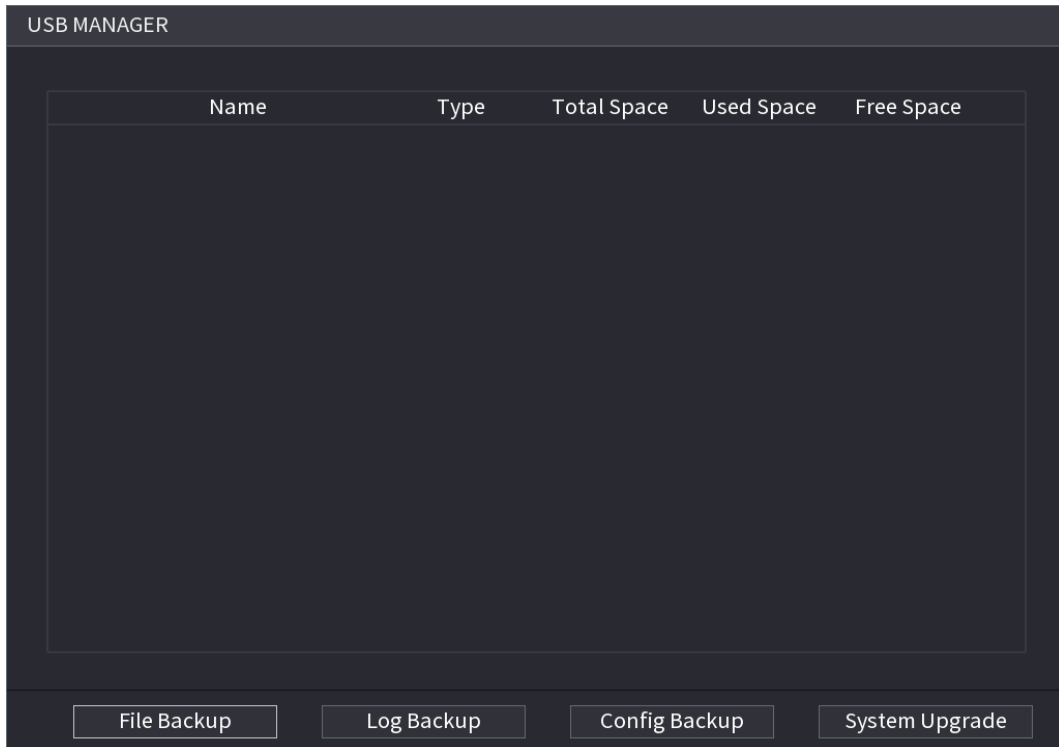

### 4.3.3 Preview Control Interface

Move your mouse to the top center of the video of current channel; you can see system pops up the preview control interface. See Figure 4-65. If your mouse stays in this area for more than 6 seconds and has no operation, the control bar automatically hides.



Slight difference may be found on the user interface.

Figure 4-65



#### 4.3.3.1 Instant Replay

You can playback the previous 5-60 minutes record of current channel.

Click  to go to the instant replay interface. See Figure 4-66.

Figure 4-66



Instant replay is to playback the previous 5 minutes to 60 minutes record of current channel.

- Move the slider to choose the time you want to start playing.
- Play, pause and close playback.
- The information such as channel name and recording status icon are shielded during instant playback and will not display until exited.
- During playback, screen split layout switch is not allowed.
- Tour high higher priority than the instant playback. The instant playback function is null when tour function is in process and the preview control interface auto hides either. The function becomes valid again after tour is complete.

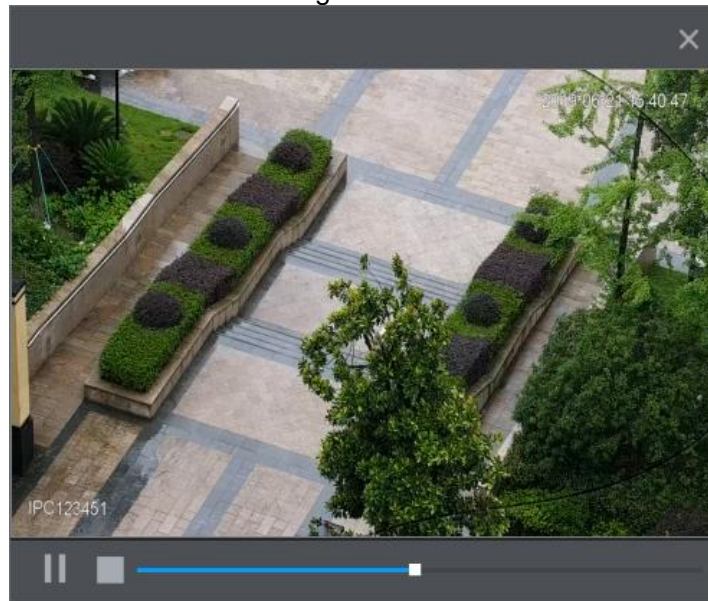

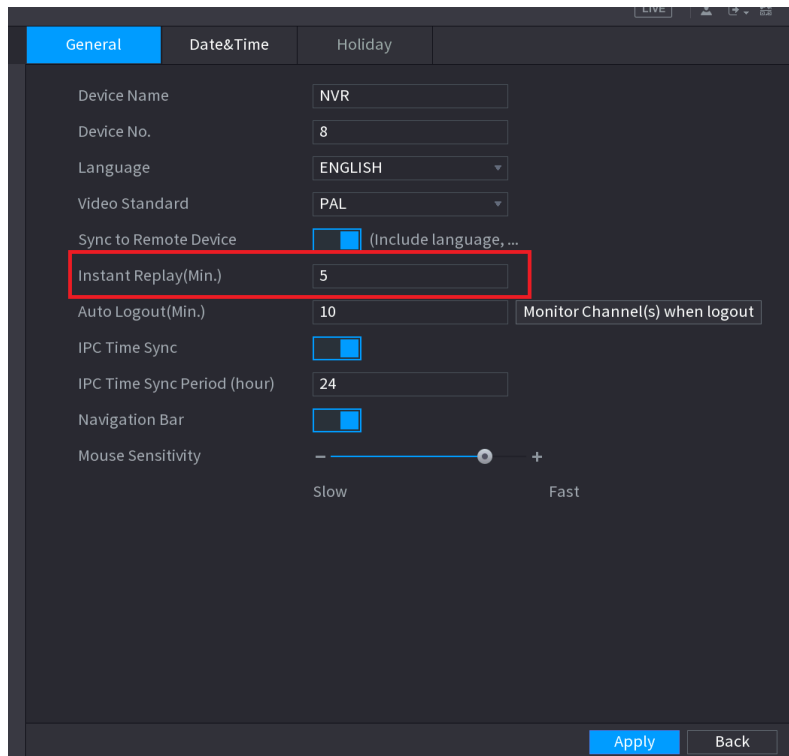

Go to the **Main Menu > SYSTEM > GENERAL > General** to set **Instant Replay** time. See Figure 4-67. System may pop up a dialogue box if there is no such record in current channel.

Figure 4-67



#### 4.3.3.2 Digital zoom

You can zoom in specified zone of current channel so that you can view the details. It supports zoom in function of multiple-channel. It includes the following two ways:

- Click , the icon switches to . Hold down the left mouse button to select the area you want to enlarge. The area is enlarged after the left mouse button is released.
- Point to the center that you want to enlarge, rotate the wheel button to enlarge the area.



- For some models, when the image is enlarged in the first way described previously, the selected area is zoomed proportionally according to the window.

The digital zoom interface is shown as in Figure 4-68. When the image is in the enlarged status, you can drag the image toward any direction to view the other enlarged areas. Right click mouse to cancel zoom and go back to the original interface.

Figure 4-68



#### 4.3.3.3 Instant backup

You can record the video of any channel and save the clip into a USB storage device.

By clicking , the recording is started. To stop recording, click this icon again. The clip is automatically saved into the connected USB storage device.

You can record the video of any channel and save the clip into a USB storage device.

#### 4.3.3.4 Manual Snapshot

You can take one to five snapshots of the video and save into a USB storage device.



By clicking , you can take snapshots. The snapshots are automatically saved into the connected USB storage device. You can view the snapshots on your PC.



To change the quantity of snapshots, select **Main Menu > CAMERA > ENCODE > Snapshot**, in the **Manual Snap** list, select the snapshot quantity.

#### 4.3.3.5 Bidirectional talk

You can perform the voice interaction between the Device and the remote device to improve efficiency of emergency.

Step 1 Click button  to start bidirectional talk function the icon now is shown as . Now the rest bidirectional talk buttons of digital channel becomes null too.

Step 2 Click  again, you can cancel bidirectional talk.

#### 4.3.3.6 Switch bit streams

Via this function, you can switch the channel main stream/sub stream according to current network bandwidth.

- M: Main stream. Its bit streams are big and definition is high. It occupies large network bandwidth suitable for video wall surveillance, storage and etc.
- S: Sub stream. Its definition is low but occupies small network bandwidth. It is suitable for general surveillance, remote connection and etc.

Click  to switch the bit stream type of the main stream and sub stream.

- M: Main stream.
- S: Sub stream. Some series products support two sub streams (S1, S2). Refer to "4.2.5.1 Encode" for detailed information.

#### 4.3.3.7 Right-Click Menu

By right-clicking the preview interface, you can quickly access the corresponding functional interface and perform relevant operations, including entering the main menu, searching records and selecting screen split mode.

Right-click on the preview interface and the right-click menu is displayed. See Figure 2-54. Refer to Table 4-18 for detailed information.



The right-click menu is different for different models. The actual interface shall prevail.



Figure 4-69

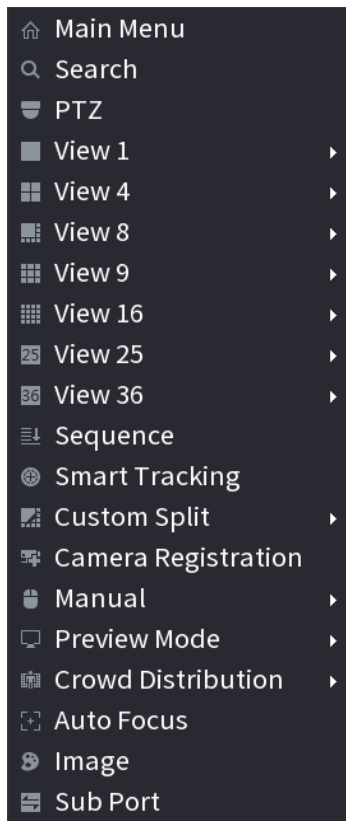

Figure 4-70

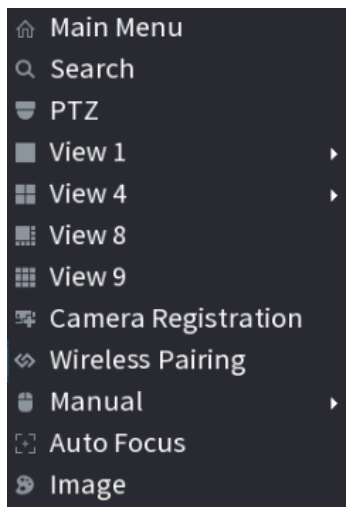
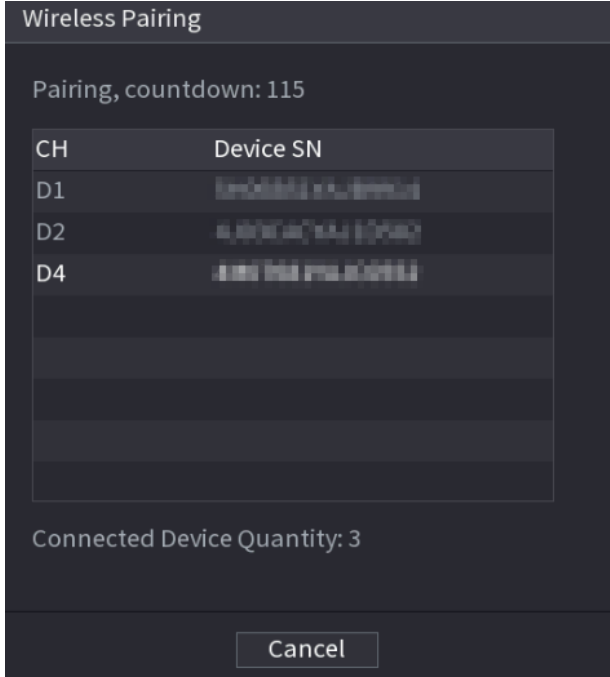

Table 4-18

Function	Description
Main Menu	Open <b>Main Menu</b> interface.
Search	Open the <b>PLAYBACK</b> interface where you can search and play back record files. For details, see "4.6 Playback and Search."
PTZ	Open the <b>PTZ</b> interface. For details, see "4.4 PTZ."
View 1/4/8/9/16/25/36	Configure the live view screen as a single-channel layout or multi-channel layout.

Function	Description
Sequence (View Layout)	<p>Set customized screen split mode and channels. For details, see "4.3.4 Wireless Pairing"</p> <p>Right-click on the screen and select <b>Wireless Paring</b>. The <b>Wireless Pairing</b> interface is displayed. See Figure 4-71.</p> <p>The device enters a 120 seconds pairing countdown.</p> <p>You can see the video of the paired IPC after pairing is successful.</p> <p style="text-align: center;">Figure 4-71</p>  <p>Sequence."</p>
Previous Screen	Click Previous Screen to go to the previous screen. For example, if you are using 4-split mode, the first screen is displaying the channel 1-4, click <b>Next screen</b> , you can view channel 5-8.
Next Screen	
Camera Registration	Open the <b>CAMERA REGISTRATION</b> interface. For details, see "4.1.4.4 Registration."
Wireless Paring	Right-click Wireless Paring to quickly add IPCs. For details, see "4.3.4"
Manual	<ul style="list-style-type: none"> <li>• Select <b>Record</b>, you can configure the recording mode as <b>Auto</b> or <b>Manual</b>, or stop the recording. You can also enable or disable snapshot function</li> <li>• Select <b>Alarm Out</b>, you can configure alarm output settings.</li> </ul>
Preview Mode	<ul style="list-style-type: none"> <li>• There are two modes: regular/AI mode.</li> </ul>
Crowd Distribution	Select enable/disable to start/stop crowd distribution function.
Auto focus	Click to realize auto focus function. Make sure the connected camera supports auto focus function.
Image	Click to modify the camera properties. For details, see "4.2.4 Image".
Sub Port	Click <b>Sub Port</b> , you can go to control the sub screen.

#### 4.3.4 Wireless Pairing

Right-click on the screen and select **Wireless Paring**. The **Wireless Pairing** interface is

displayed. See

Figure 4-71.

The device enters a 120 seconds pairing countdown.

You can see the video of the paired IPC after pairing is successful.

Figure 4-71

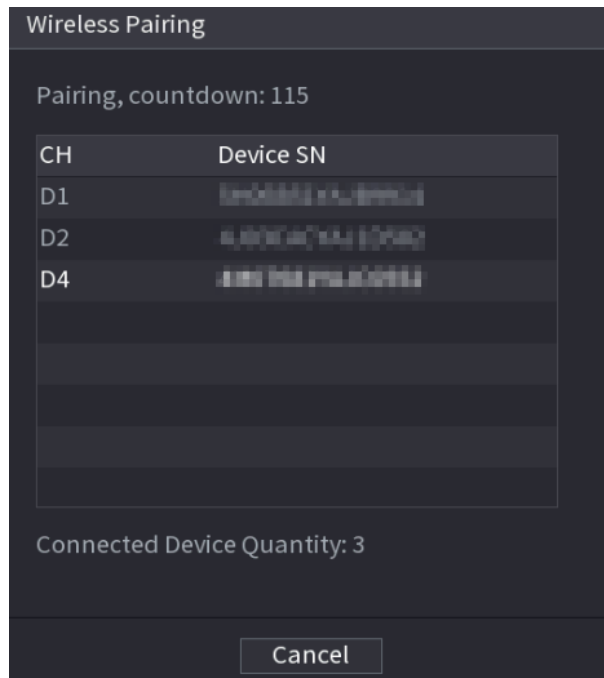

### 4.3.5 Sequence

You can set customized view layout.



The preview layout restores default channel layout after Default operation.

Step 1 On the preview interface, right click mouse and then click **Sequence**.

Step1 The **Sequence** interface is displayed.





- Enter edit view interface, device automatically switches to the max split amount mode.
- The channel list on the edit view interface displays the added camera channel number and channel name.  means camera is online.  means camera is offline.
- In case the channel amount has exceeded the device max split amount, the edit view interface can display the max screen number amount and current screen number.

Figure 4-72



Step 2 On the edit view interface, drag the channel to the desired window, or drag on the preview window to switch the position.

Step2 Check the channel number at the right bottom corner to view the current channel sequence.

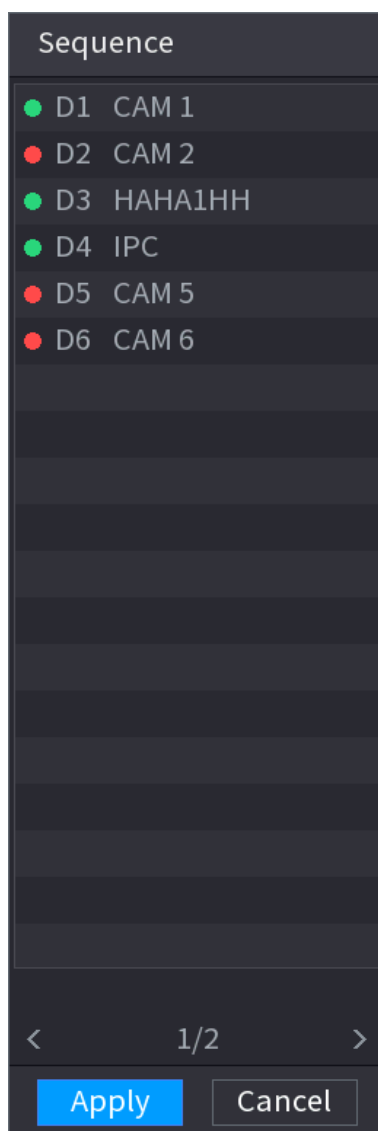
Figure 4-73

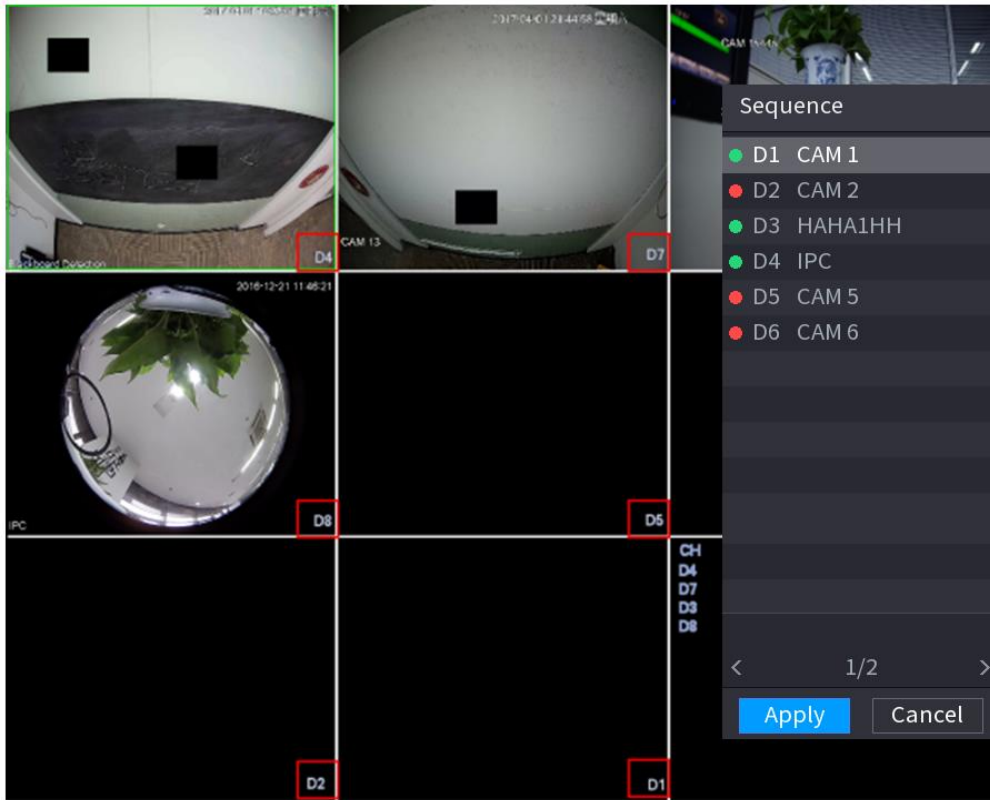

- Step 3** Click **Apply** to save current channel sequence.  
After you change the channel sequence, click Cancel button or right click mouse, device pops up the dialogue box. See Figure 4-74.
- Click **OK** to save current settings.
  - Click **No** to exit without saving the settings.

Figure 4-74

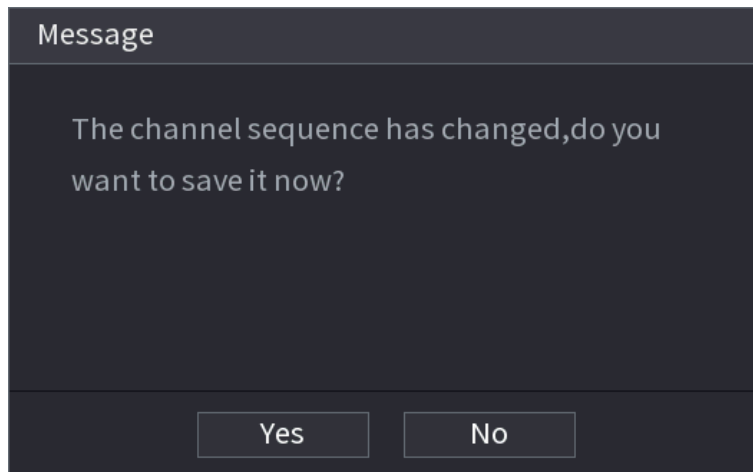

## 4.3.6 Fisheye (Optional)



This function is for some series products only.

### 4.3.6.1 Fisheye de-warp during preview interface

The fisheye camera (panoramic camera) has wide video of angle but its video is seriously distorted. The de-warp function can present the proper and vivid video suitable for human eyes.

On the preview interface, select fisheye channel and then right click mouse, you can select fish eye. See Figure 4-75. You can set fisheye installation mode and display mode.



- For the non-fish eye channel, system pops up dialogue box to remind you it is not a fish eye channel and does not support de-warp function.
- If system resources are insufficient, system pops up the corresponding dialogue box too.

Figure 4-75

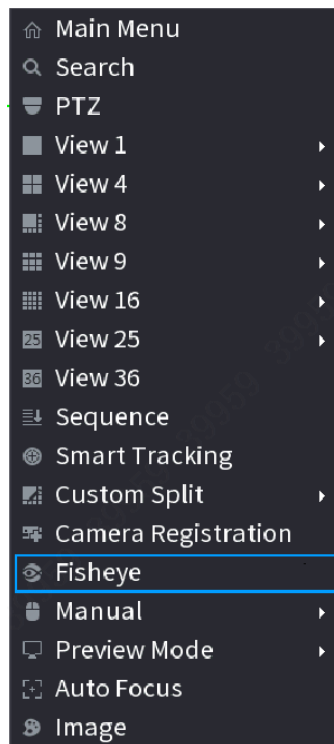

Now you can see an interface shown as Figure 4-76. You can set fish eye installation mode and display mode. There are three installation modes: ceiling mount/wall mount/ground mount.



- The different installations modes have different de-warp modes.
- Some series products support 180° de-warp. 180° de-warp fisheye supports wall mount de-warp only. The actual product shall prevail.

Figure 4-76

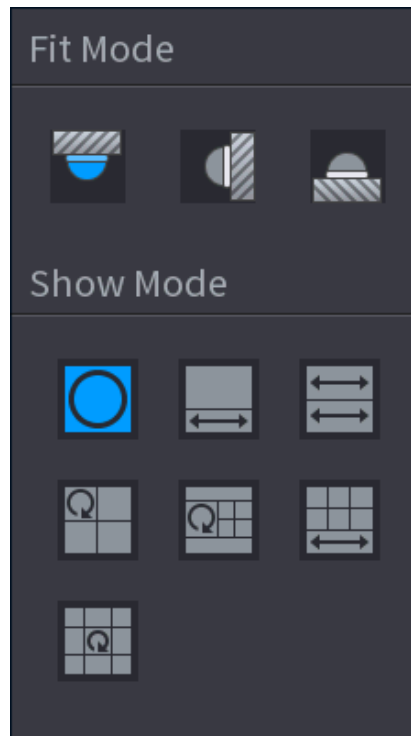

Refer to the following sheet for detailed information. See Table 4-19.

Table 4-19















Installation modes	Icon	Note
 (Ceiling mount)  (Ground mount)		360°panorama original view
		1 de-warp window+1 panorama stretching
		2 panorama stretching view
		1 360° panorama view+3 de-warp windows
		1 360°panorama view+4 de-warp windows
		4 de-warp windows+1 panorama stretching
		1 360° panorama view+8 de-warp windows
 (Wall mount)		360°panorama original view
		Panorama stretching
		1 panorama unfolding view+3 de-warp windows
		1 panorama unfolding view +4 de warp windows
		1 panorama unfolding view +8 de warp windows

Figure 4-77



In Figure 4-77, you can adjust the color pane on the left pane or use your mouse to change the position of the small images on the right pane to realize fish eye de-warp.

Operation: Use mouse to zoom in/zoom out, move, and rotate the image (Not for wall mount mode.)

#### 4.3.6.2 Fish eye de-warp during playback

When playing back the fisheye record file, you can use de-warp function to adjust video.

**Step 1** On the main menu, click **Backup** button.

**Step 2** Select 1-window playback mode and corresponding fish eye channel, click  to play.

**Step 3** Right click the , you can go to the de-warp playback interface. For detailed information, refer to "4.3.6.1 Fisheye de-warp during preview interface".

#### 4.3.6.3 Test Temperature

When connecting to the front-end device that supports temperature detection, system can display instant temperature.



- This function may collect the human temperature in the surveillance video, be careful!
- This function is for some series products only.

#### Preparations

Refer to "4.17.1 Display" to enable test temperature function.

On the preview window, click any position on the thermal channel video. The interface is shown as below. See Figure 4-78.



Figure 4-78

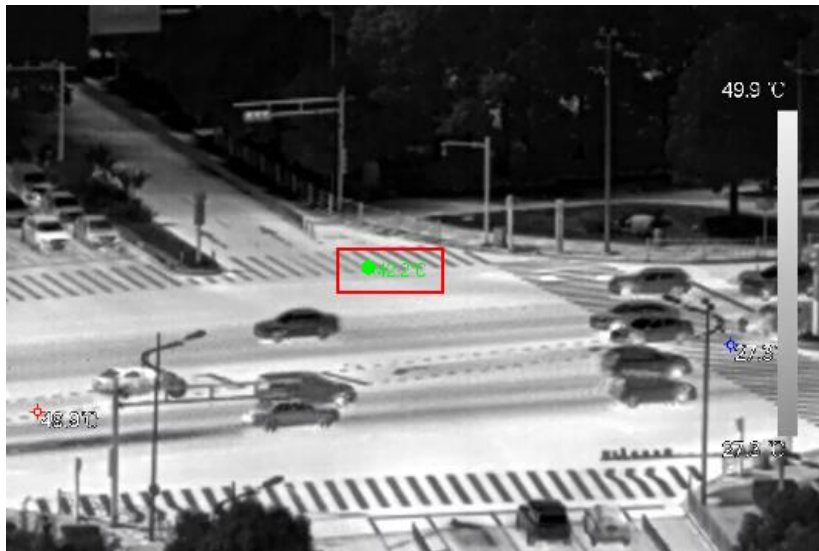

### 4.3.7 AI Preview Mode

When you select AI mode, the system displays information of human face, personnel, vehicle and non-motor vehicle on the right side of the preview interface, and it supports to play back records and display feature attributes.



You need to enable face detection, body detection, vehicle detection and non-motor vehicle detection to support this function. For details, see "4.7.2.5 Video Structuring (Metadata)."

- Step 1** Right click to select **Preview Mode > AI Mode**.  
The AI preview interface is displayed. See Figure 2-60.

Figure 4-79

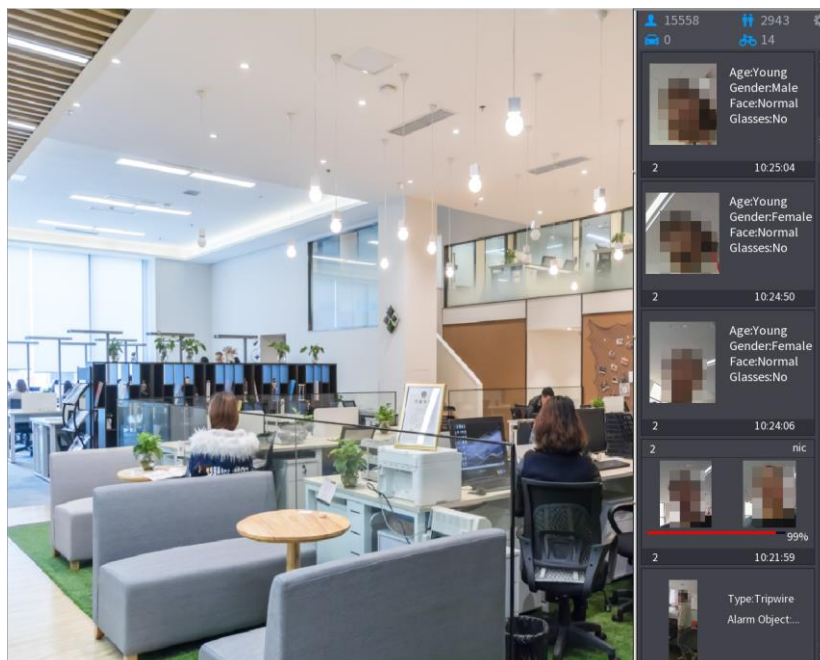

- Step 2** (Optional) Double-click the image on the right to play the corresponding video.

- Step 3** Click .  
The **Properties** interface is displayed. See Figure 2-59.

Figure 4-80



Step 4 (Optional) Click **Show Face List** and select attributes to display, including age, gender, expression, glasses, beard and mask.

Step 5 (Optional) Click **Human Body Detection** and select attributes to display, including top, pants, hat, bag, bag style, umbrella, age and gender. See Figure 4-81.

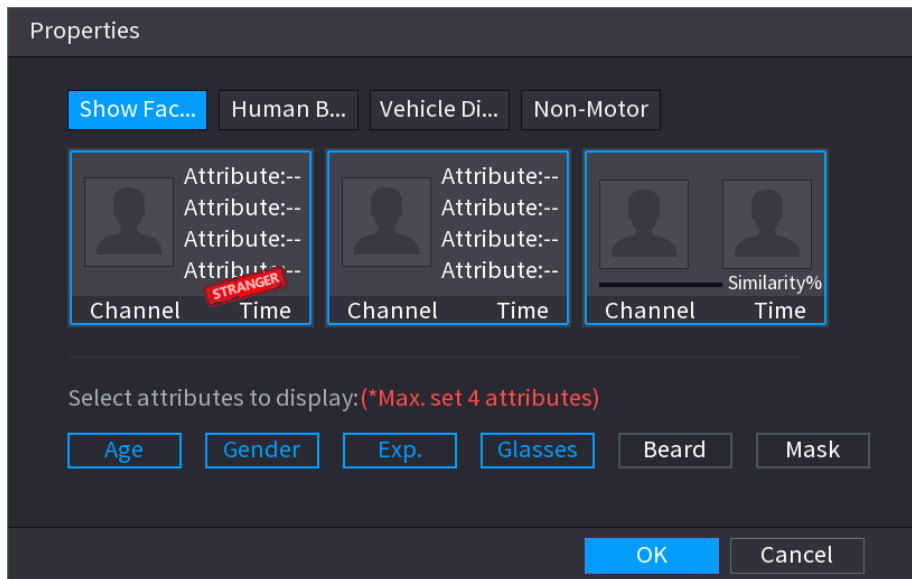
Figure 4-81

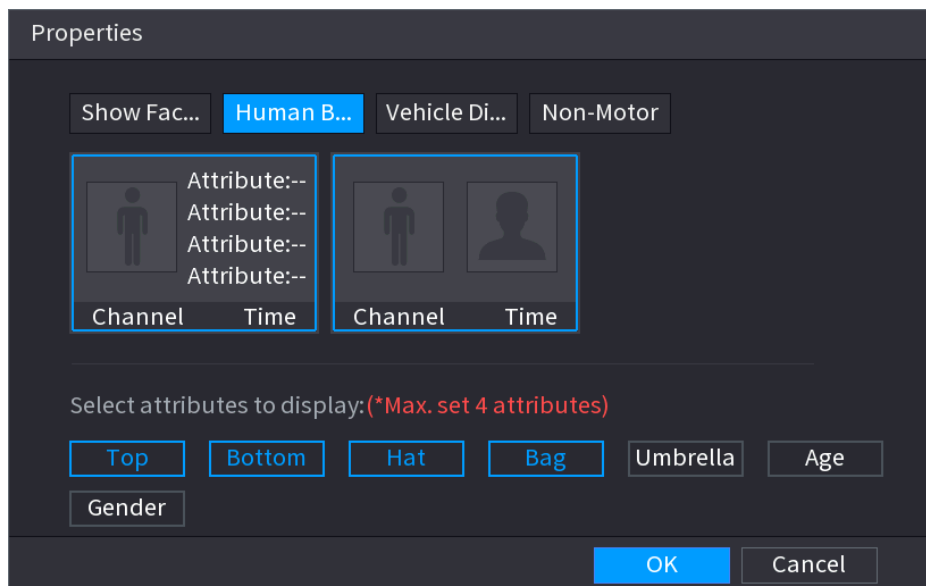

Step 6 (Optional) Click **Vehicle Display** and select attributes to display, including vehicle logo, vehicle color, vehicle model, plate recognition, plate color, seatbelt, call, vehicle decorations and countries & regions.

Figure 4-82

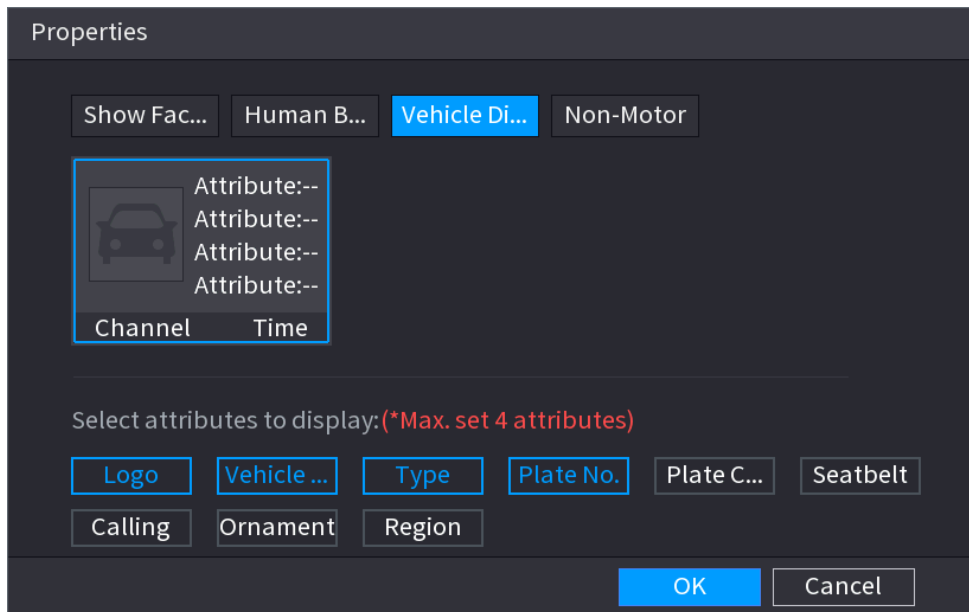

**Step 7** (Optional) Click **Non-Motor** and select attributes to display, including color, type and people number. See Figure 4-83.

Figure 4-83

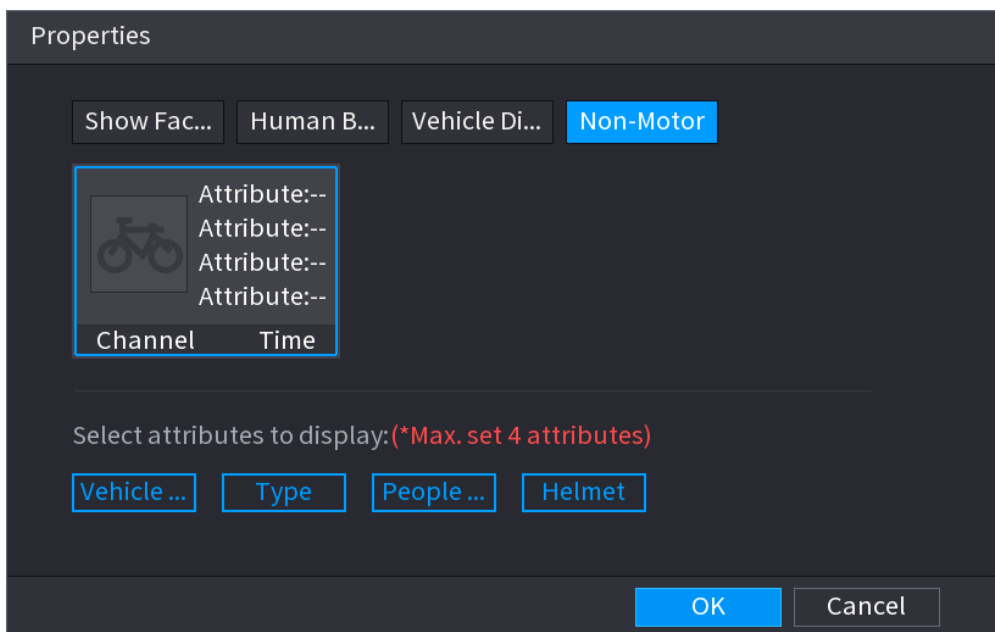

**Step 8** Click **OK** to complete the setting.



The system can display four attributes at most.

## 4.4 PTZ

PTZ is a mechanical platform that carries a camera and a protective cover and performs overall control remotely. A PTZ can move in both horizontal and vertical direction to provide all-around view to the camera.



Before you control the PTZ, make sure the PTZ decoder and the NVR network connection is OK.

### 4.4.1 PTZ Settings

You can set different PTZ parameters for local type and remote type. Before you use local PTZ,

make sure you have set PTZ protocol; otherwise you cannot control the local PTZ.

- Local: The PTZ device connects to the NVR via the cable.
- Remote: The PTZ device connects to the NVR via the network.



This function is for some series products only.

**Step 1** Select **Main menu > CAMERA > PTZ**.

The **PTZ** interface is displayed. See Figure 4-84 (Local) or Figure 4-85 (Remote).

Figure 4-84

Channel	D1
PTZ Type	Local
Protocol	NONE
Address	1
Baud Rate	9600
Data Bits	8
Stop Bits	1
Check	None

Copy Apply Back

Figure 4-85

The screenshot shows a configuration window with a dark background. At the top, there are two dropdown menus: 'Channel' with 'D1' selected and 'PTZ Type' with 'Remote' selected. At the bottom, there are three buttons: 'Copy' (grey), 'Apply' (blue), and 'Back' (grey).

**Step 2** Configure parameters. See Table 4-20.

Table 4-20

Parameter	Description
Channel	In the <b>Channel</b> list, select the channel that you want to connect the PTZ camera to.
PTZ Type	<ul style="list-style-type: none"> <li>Local: Connect through RS-485 port.</li> <li>Remote: Connect through network by adding IP address of PTZ camera to the Device.</li> </ul>
Protocol	In the <b>Protocol</b> list, select the protocol for the PTZ camera such as PELCOD.
Address	In the <b>Address</b> box, enter the address for PTZ camera. The default is 1.  The entered address must be the same with the address configured on the PTZ camera; otherwise the system cannot control PTZ camera.
Baud rate	In the <b>Baud rate</b> list, select the baud rate for the PTZ camera. The default is 9600.
Data Bits	The default is 8.
Stop Bits	The default is 1.
Parity	The default is NONE.

**Step 3** Click **Apply**.

#### 4.4.2 PTZ Control

PTZ control panel performs the operations such as directing camera in eight directions, adjusting zoom, focus and iris settings, and quick positioning.

## Basic PTZ Control Panel





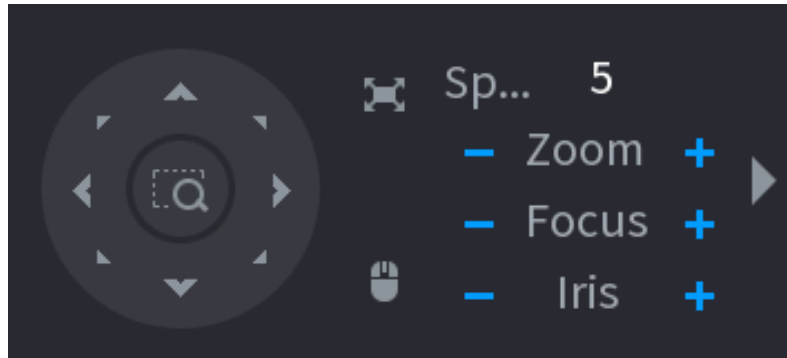







Right-click on the live view screen and then select PTZ. The PTZ control panel is displayed. See Figure 4-86.

Figure 4-86

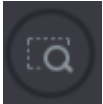

- The gray button means system does not support current function.
- For some series products, the PTZ function is valid in one-window mode.

Table 4-21

Parameter	Description
Speed	Controls the movement speed. The bigger the value is, the faster the movement will be.
Zoom	 : Zoom out.  : Zoom in.
Focus	 : Focus far.  : Focus near.
Iris	 : Image darker.  : Image brighter.
PTZ movement	Supports eight directions.
	Fast positioning button. <ul style="list-style-type: none"> <li>• Positioning: Click  to enter the fast positioning screen, and then click anywhere on the live view screen, the PTZ will turn to this point and move it to the middle of the screen.</li> <li>• Zooming: On the fast positioning screen, drag to draw a square on the view. The square supports zooming.</li> <li>• Dragging upward is to zoom out, and dragging downward is to zoom in.</li> <li>• The smaller the square, the larger the zoom effect.</li> </ul>  This function is for some series products only and can only be controlled through mouse operations.
	Click  , you can control the four directions (left, right, up, and down) PTZ movement through mouse operation.
	Click  to open the expanded PTZ control panel.

## Expanded PTZ Control Panel

On the basic PTZ control panel, click  to open the expanded PTZ control panel to find more options. See Figure 4-87.

Figure 4-87



- The functions with buttons in gray are not supported by the system.
- Right-click once to return to the interface of PTZ basic control panel.

Table 4-22

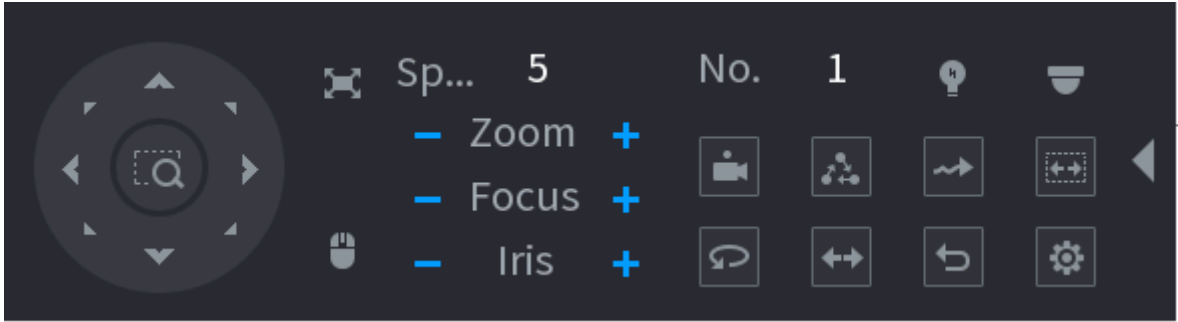
Icon	Function	Icon	Function
	Preset		Auto Pan
	Tour		Flip
	Pattern		Reset
	Auto scan		Click the <b>AUX Config</b> icon to open the PTZ functions settings interface.
	AUX Switch		Click the <b>Enter Menu</b> icon to open the <b>MENU OPERATION</b> interface.

### 4.4.3 Configuring PTZ Functions

#### 4.4.3.1 Configuring Presets

- Step 1 On the Expanded PTZ Control Panel, click . The **Preset** interface is displayed. See Figure 4-88.

Figure 4-88

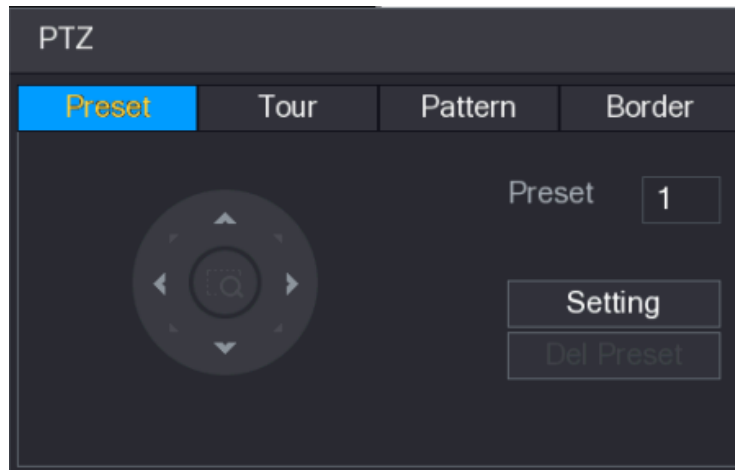

Step 2 Click the direction arrows to the required position.

Step 3 In the **Preset** box, enter the value to represent the required position.

Step 4 Click **Setting** to complete the preset settings.

#### 4.4.3.2 Configuring Tours

Step 1 On the Expanded PTZ Control Panel, click .  
The **PTZ** interface is displayed.

Step 2 Click the **Tour** tab.  
The **Tour** tab is displayed. See Figure 4-89.

Figure 4-89

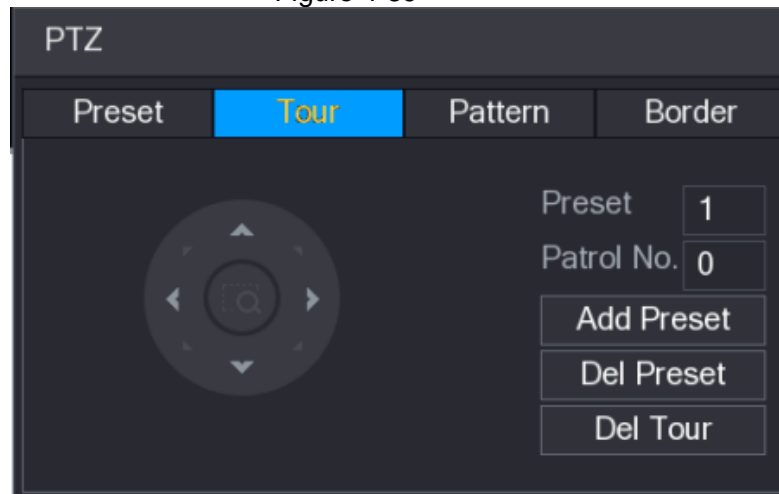

Step 3 In the **Patrol No.** box, enter the value for the tour route.

Step 4 In the **Preset** box, enter the preset value.

Step 5 Click **Add Preset**.

A preset will be added for this tour.



- You can repeat adding more presets.
- Click **Del Preset** to delete the preset for this tour. This operation can be repeated to delete more presets. Some protocols do not support deleting.

#### 4.4.3.3 Configuring Patterns

Step 1 On the Expanded PTZ Control Panel, click .  
The **PTZ** interface is displayed.

Step 2 Click the **Pattern** tab.  
The **Pattern** interface is displayed. See Figure 4-90.



Figure 4-90

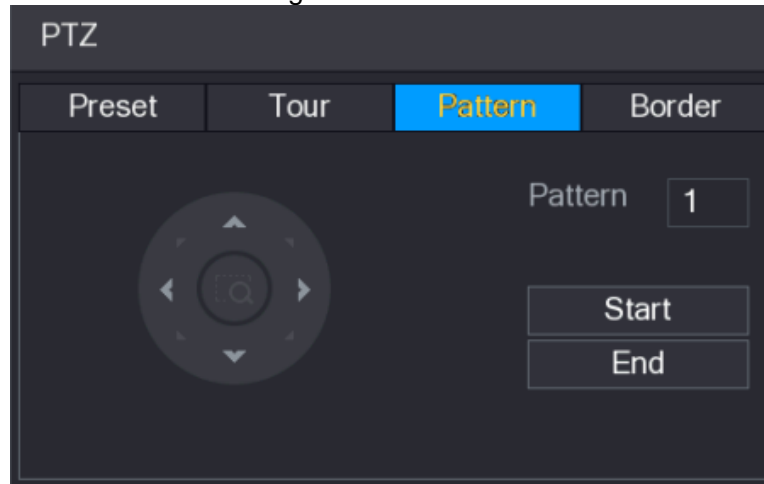

**Step 3** In the **Pattern** box, enter the value for pattern.

**Step 4** Click **Start** to perform the directions operations. You can also go to the PTZ Control Panel to perform the operations of adjusting zoom, focus, iris, and directions.

**Step 5** On the **PTZ** interface, click **End** to complete the settings.

#### 4.4.3.4 Configuring AutoScan

**Step 1** On the Expanded PTZ Control Panel, click . The **PTZ** interface is displayed.

**Step 2** Click the **Border** tab. The **Border** interface is displayed. See Figure 4-91.

Figure 4-91

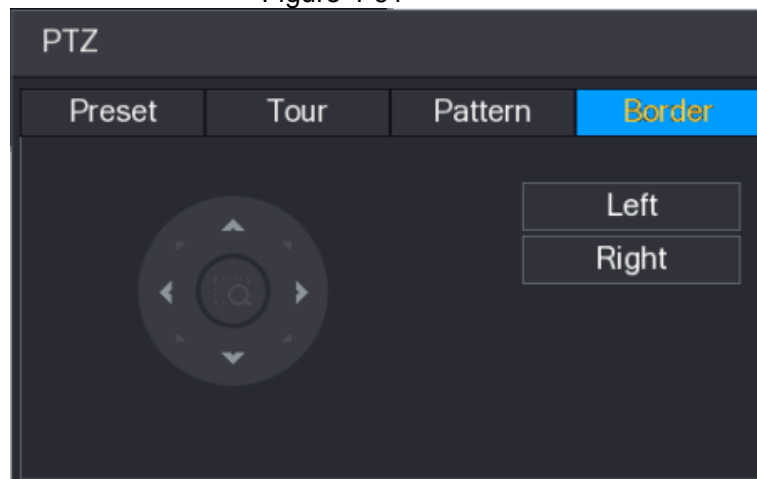

**Step 3** Click the direction arrows to position the left and right borders.

#### 4.4.4 Calling PTZ Functions

After you have configured the PTZ settings, you can call the PTZ functions for monitoring from the Expanded PTZ Control Panel. See Figure 4-92.

Figure 4-92

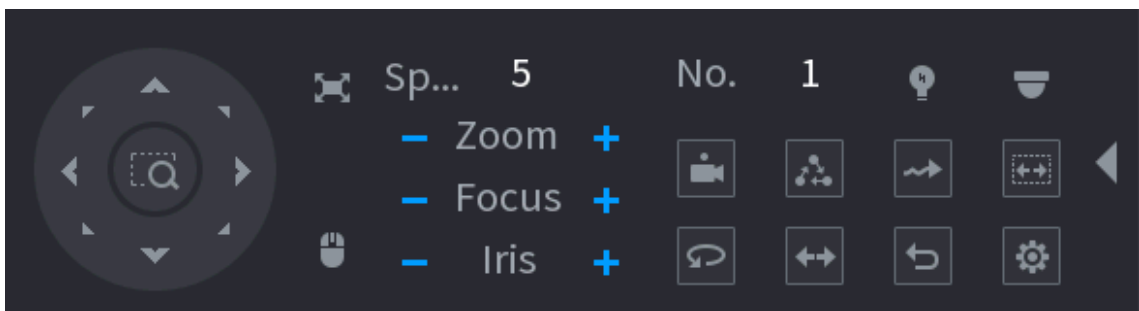

##### 4.4.4.1 Calling Presets

**Step 1** On the Expanded PTZ Control Panel, in the **No.** box, enter the value of the preset that you want to call.

**Step 2** Click  to call the preset.

**Step 3** Click  again to stop calling the preset.

#### 4.4.4.2 Calling Tours

**Step 1** On the Expanded PTZ Control Panel, in the **No.** box, enter the value of the tour that you want to call.

**Step 2** Click  to call the tour.

**Step 3** Click  again to stop calling the tour.

#### 4.4.4.3 Calling Patterns

**Step 1** On the Expanded PTZ Control Panel, in the **No.** box, enter the value of the pattern that you want to call.

**Step 2** Call  to call the pattern.  
The PTZ camera moves according to the configured pattern repeatedly.

**Step 3** Click  again to stop calling the pattern.

#### 4.4.4.4 Calling AutoScan

**Step 1** On the Expanded PTZ Control Panel, in the **No.** box, enter the value of the border that you want to call.

**Step 2** Click .  
The PTZ camera performs scanning according to the configured borders.

**Step 3** Click  again to stop auto scanning.

#### 4.4.4.5 Calling AutoPan

**Step 1** On the Expanded PTZ Control Panel, click  to start moving in horizontal direction.

**Step 2** Click  again to stop moving.

#### 4.4.4.6 Using AUX Button

On the Expanded PTZ Control Panel, click , the AUX setting interface is displayed. See Figure 4-93.

In the **Direct Aux** list, select the option that corresponds to the applied protocol.

In the **Aux Num** box, enter the number that corresponds to the AUX switch on the decoder.

Figure 4-93

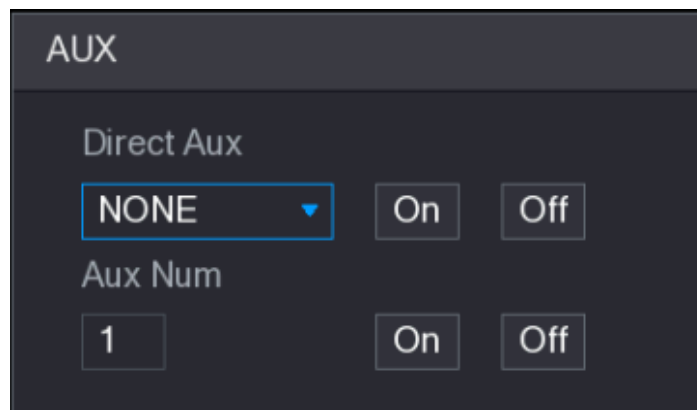

## 4.5 Record File

Device adopts 24-hour continuous record by default. It supports customized record period and record type. Refer to "4.1.4.6 Schedule" for detailed information.

## 4.6 Playback and Search

### 4.6.1 Instant Playback

You can view the record file of previous 5 to 60 minutes. Refer to "4.3.2 Navigation bar" for instant playback information.

## 4.6.2 Search Interface

You can search and playback the record file on the NVR.

Select **Main Menu > PLAYBACK**, or on the preview interface right click mouse and then select **Search**, you can go to the following interface. See Figure 4-94.



The following figure for reference only.

Figure 4-94

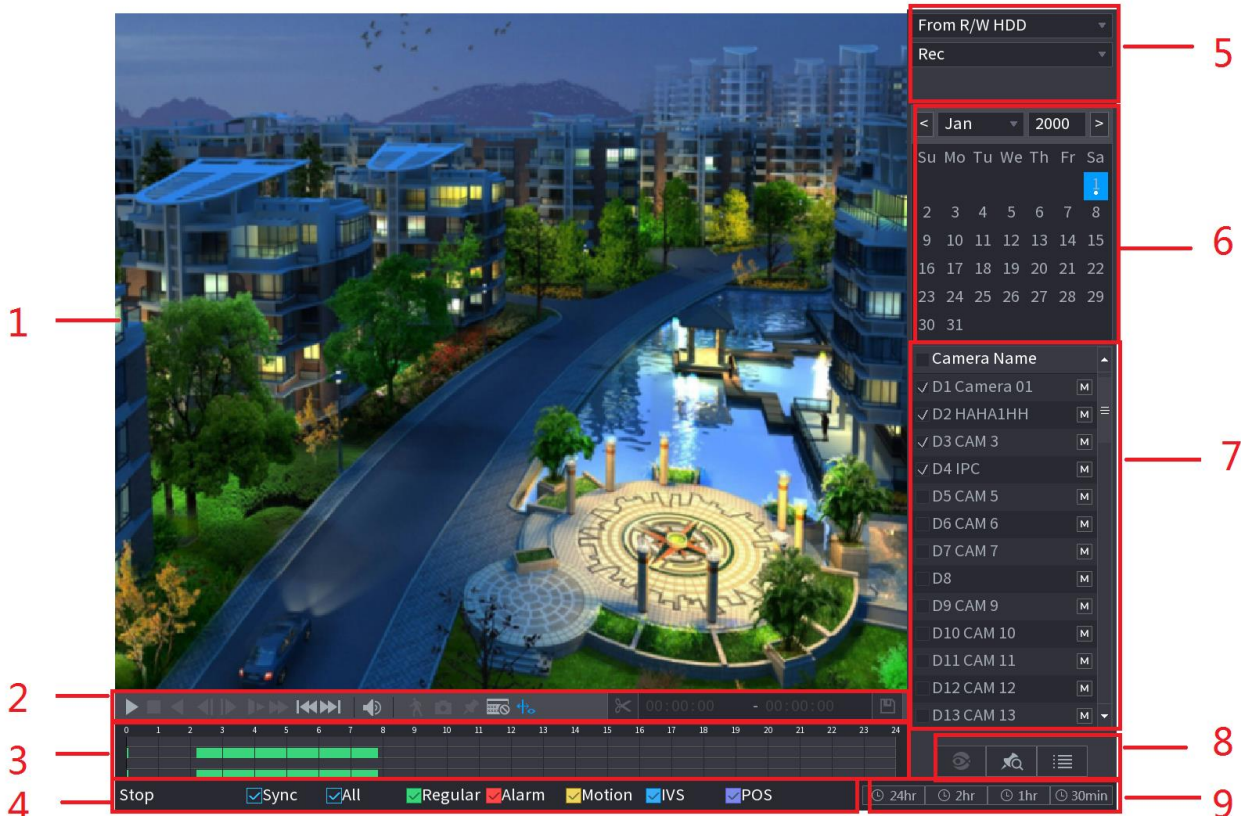









Table 4-23

No.	Function	Description
1	Display Window	<p>Display the searched recorded video or picture. It supports playing in single-channel, 4-channel, 9-channel, and 16-channel simultaneously.</p> <p> When playing back in a single channel mode, hold down the left mouse button to select the area that you want to enlarge. The area is enlarged after the left mouse button is released. To exit the enlarged status, right-click on the image.</p>
2	Playback Controls Bar	Playback control buttons. Refer to "4.6.2.1 Playback Control" for detailed information.
	Clip	Click  to edit the record file and then save specified footages. Refer to "4.6.2.3 Clip" for detailed information.
	Backup	Click  to backup record. Refer to "4.6.2.4 Record Backup" for detailed information.

No.	Function	Description
3	Time Bar	<p>Display the type and time period of the current recorded video.</p> <ul style="list-style-type: none"> <li>In the 4-channel layout, there are four time bars are displayed; in the other view layouts, only one time bar is displayed.</li> <li>Click on the colored area to start playback from a certain time.</li> <li>In the situation when you are configuring the settings, rotate the wheel button on the time bar, the time bar is zooming in from 0. In the situation when playback is ongoing, rotate the wheel button on the time bar, the time bar is zooming from the time point where the playback is located.</li> <li>Time bar colors: Green indicates general type; Red indicates external alarm; Yellow indicates motion detection; Blue indicates intelligent events; Purple indicates POS events.</li> <li>For some models, when you are clicking on the blank area in the time bar, the system automatically jumps to the next time point where there is a recorded video located.</li> </ul>
4	Play Status	Includes two playback status: <b>Play</b> and <b>Stop</b> .
	Sync	Select the <b>Sync</b> check box to simultaneously play recorded videos of different channels in the same period in multi-channel view.
	Record type	Select the check box to define the recording type to search for.
5	Search type	Select the content to play back: <b>Record, PIC, Splice Playback</b> . For details about the selecting search type, refer to "4.6.2.2 Search Type" for detailed information.
6	Calendar	<p>Click the date that you want to search, the time bar displays the corresponding record.</p> <p>The dates with record or snapshot have a small solid circle under the date.</p>
7	View Layout and Channel Selection	<ul style="list-style-type: none"> <li>In the <b>CAM NAME</b> list, select the channel(s) that you want to play back.</li> <li>The window split is decided by how you select the channel(s). For example, if you select one channel, the playback is displayed in the single-channel view; if you select two to four channels, the playback is displayed in the four-channel view. The maximum is eight channels.</li> <li>Click  to switch the streams.  indicates main stream, and  indicates sub stream.</li> </ul>
8	List Display	<p>This area includes <b>Mark List</b> and <b>File List</b>.</p> <p> Different series products have different functions. The icons displayed may vary. The actual product shall prevail.</p> <ul style="list-style-type: none"> <li>: Click the <b>Mark List</b> button, the marked recorded video list is displayed. Double-click the file to start playing.</li> <li>: Click the <b>File List</b> button, the searched recorded video list is displayed. You can lock/unlock the files. Refer to "4.6.7 File List " for detailed information.</li> <li>: Fisheye dewarp. It is to display the dewarp fisheye video. Refer to "4.3.6.2 Fish eye de-warp during playback" for detailed information.</li> </ul>
14	Time Bar Unit	You can select 24hr, 2hr, 1hr, or 30min as the unit of time bar. The time bar display changes with the setting.



All the operations here (such as playback speed, channel, time and progress) have relationship with hardware version. Some series NVRs do not support some functions or playback speeds.

#### 4.6.2.1 Playback Control

The playback control interface is shown as below. See Figure 4-95.



Figure 4-95



Refer to the following sheet for more information. See Table 4-24.

Table 4-24

Icon	Function
	Play/Pause In slow play mode, click it to switch between play/pause.
	Stop When playing back, click to stop current playback process.
	Backward play <ul style="list-style-type: none"> <li>● In normal play mode, left click the button, the file begins backward play. Click it again to pause current play.</li> <li>● In backward play mode, click  or  to restore normal play.</li> </ul>
	Display previous frame/next frame. <ul style="list-style-type: none"> <li>● When pause the normal playback file, click  or  to playback frame by frame.</li> <li>● In frame by frame playback mode, click  or  to resume normal playback mode.</li> </ul>
	Slow play In playback mode, click it to realize various slow play modes such as slow play 1, slow play 2, and etc.
	Fast forward In playback mode, click to realize various fast play modes such as fast play 1, fast play 2 and etc.
	Adjust the volume of the playback.
	Smart search . Refer to "4.6.3 Smart Search Playback" for detailed information.
	Click the snapshot button in the full-screen mode, the system can snapshot 1 picture. System supports custom snap picture saved path. Connect the peripheral device first, click snap button on the full-screen mode, you can select or create path. Click Start button, the snapshot picture can be saved to the specified path.
	Mark button. This function is for some series product only. Make sure there is a mark button in the playback control pane. Refer to "4.6.4 Mark Playback" for detailed information.
	Display/hide POS information. In 1-channel playback mode, you can click it to display/hide POS information on the video.

Icon	Function
	In 1-channel playback mode, click it to enable/disable display IVS rule information on the video.  This function is for some series only.

#### 4.6.2.2 Search Type

You can search the recorded videos, splice, or snapshots from HDD or external storage device.

- **From R/W HDD:** Recorded videos or snapshots playback from HDD of the Device. See Figure 4-96.

Figure 4-96

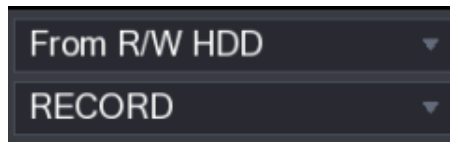

- **From I/O Device:** Recorded videos playback from external storage device. See Figure 4-97.

Click **Browse**, select the save path of recorded video file that you want to play.

Double-click the video file or click  to start playing.

Figure 4-97



#### 4.6.2.3 Clip

This function allows you to clip some footages to a new file and then save it to the USB device. See Figure 2-4. Follow the steps listed below.

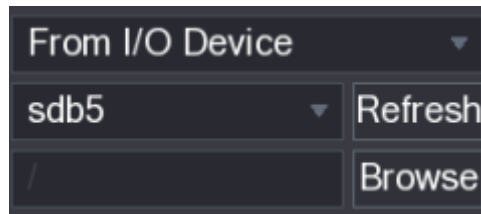
Step 1 Select a record first and then click  to playback.

Step 2 Select a time at the time bar and then click  to start clip,

Step 3 Select a time at the time bar and then click  to stop clip,

Step 4 Click , system pops up dialogue box to save the clip file.

Figure 4-98



- Clip function is for one-channel/multiple-channel.
- Max save 1024 files at the same time.
- This function is not for the file already checked in the file list.

#### 4.6.2.4 Record Backup

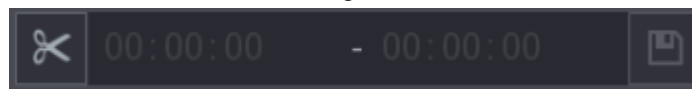
This function is to backup files you checked in the file list, or the file you just clip.

Step 1 Select the recorded video file that you want to back up. You can select the following two types of files:

- Recorded video file: Click , the **File List** area is displayed. Select the file(s) that you want to back up.
- Saves the clip footages as a record file.

Step 2 Click , the **BACKUP** interface is displayed. See Figure 4-99.

Figure 4-99

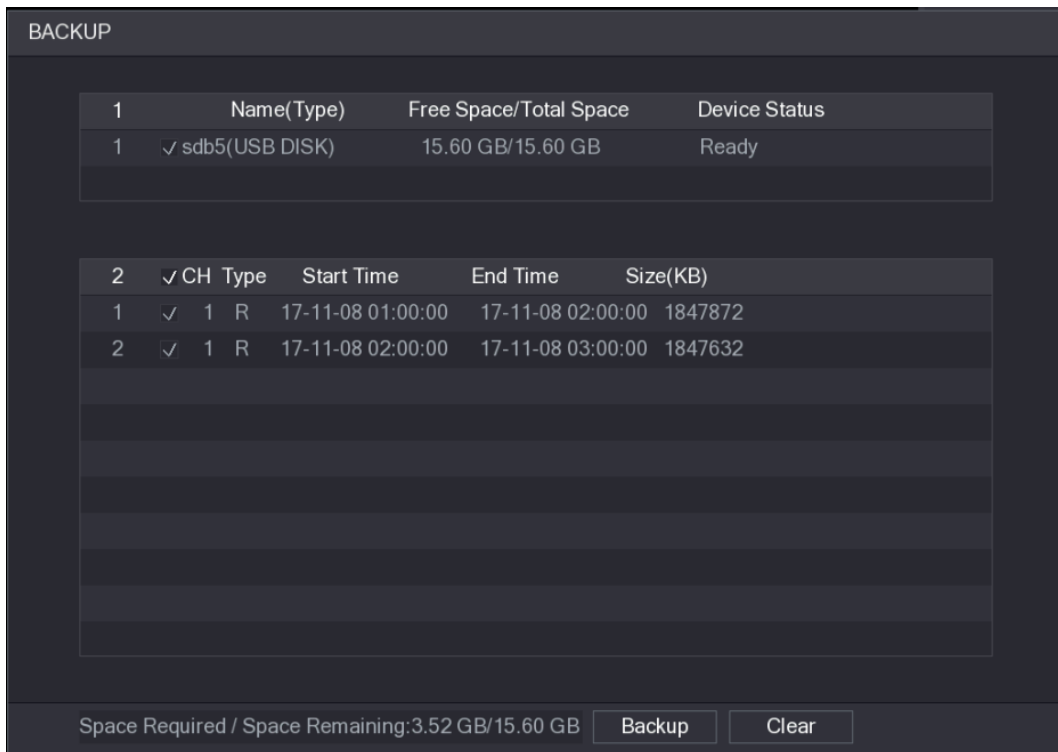

Step 3 Click **Backup** to begin the process.

### 4.6.3 Smart Search Playback



This function is for some series product only.

During playback process, it can analyze the motion detect zone in the scene and give the analysis result.

This function is for channel that already enabled motion detect function (**Main Menu > ALARM > VIDEO DETECT > Motion Detect**).

Step 1 Select a channel to playback video and then click . You can view the grids on the playback video.



- This function is for one-channel playback mode.
- If you are in multiple-channel playback mode, double-click a channel first to switch to one-channel playback mode.

Step 2 Left click mouse and then drag to select smart search zones(22\*18 (PAL) , 22\*15 (NTSC) ).



Step 3 Click  to go to smart search and playback. System is going to playback all motion detect record footages.

Step 4 Click  again to stop smart search function.



- The motion detect region cannot be the full screen zone.
- The motion detect region adopts the current whole play pane by default.
- Selects the other file on the list, system begins playing the motion detect footages of other file.
- The time bar unit switch, backward play, frame by frame are null when system is playing motion detect file.

### 4.6.4 Mark Playback

When you are playback record, you can mark the record when there is important information. After playback, you can use time or the mark key words to search corresponding record and

then play. It is very easy for you to get the important video information.

- Add Mark

When system is playback, click Mark button , you can go to the following interface. See Figure 4-100.

Figure 4-100

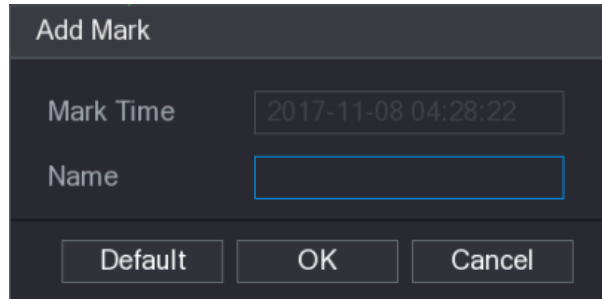

The 'Add Mark' dialog box contains the following fields and buttons:

- Mark Time: 2017-11-08 04:28:22
- Name: (empty text box)
- Buttons: Default, OK, Cancel

- Playback Mark

During 1-window playback mode, click mark file list button  in Figure 4-94, you can go to mark file list interface. Double-click one mark file, you can begin playback from the mark time.

- Play before mark time

Here you can set to begin playback from previous N seconds of the mark time.



Usually, system can playbacks previous N seconds record if there is such kind of record file. Otherwise, system playbacks from the previous X seconds when there is such as kind of record.

- Mark Manager

Click the mark manager button  on the Search interface (Figure 4-94); you can go to **Manager** interface. See Figure 4-101. System can manage all the record mark information of current channel by default. You can view all mark information of current channel by time.

Figure 4-101



The 'Manager' dialog box contains the following fields and table:

- Channel: 5
- Start Time: 2017-11-08 00:00:00
- End Time: 2017-11-09 00:00:00
- Search button
- Table:

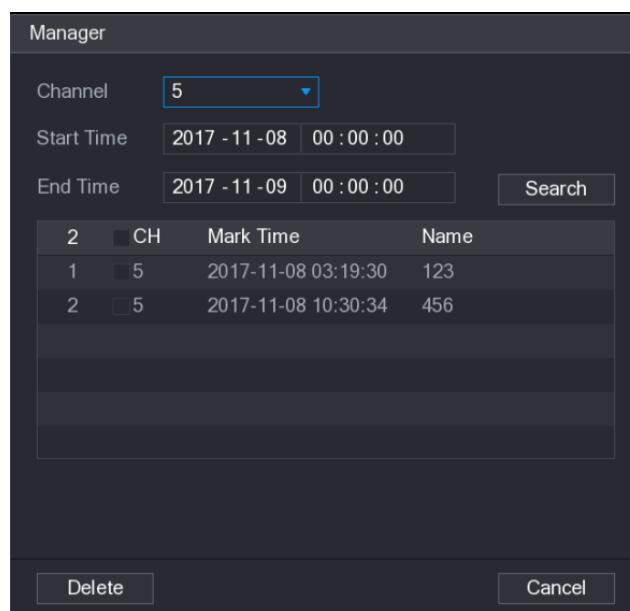
	CH	Mark Time	Name
1	5	2017-11-08 03:19:30	123
2	5	2017-11-08 10:30:34	456

Buttons: Delete, Cancel

- Modify

Double-click one mark information item, you can see system pops up a dialogue box for you to



change mark information. You can only change mark name here.

- **Delete**

Here you can check the mark information item you want to delete and then click Delete button, you can remove one mark item.



- After you go to the mark management interface, system needs to pause current playback. System resume playback after you exit mark management interface.
- If the mark file you want to playback has been removed, system begins playback from the first file in the list.

#### 4.6.5 Playback Image

Here you can search and play the image. Follow the steps listed below.

Step 1 Select **Main Menu > PLAYBACK**, or on the preview window right click mouse and then click **Search**, you can go to the **Search** interface.

Step 2 At the top right corner, select image and then input playback interval.

Step 3 Select date and channel, click  to play.

#### 4.6.6 Splice Playback

You can clip the recorded video files into splices and then play back at the same time to save your time.



This function is for some series products only.

Step 1 Select **Main Menu > PLAYBACK**, the **PLAYBACK** interface is displayed.

Step 2 In the **Search Type** list, select **Splice Playback**; In the Split Mode list, select **4, 9, or 16**. See Figure 4-102.

Figure 4-102

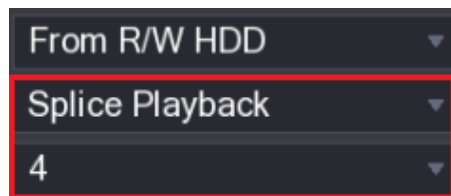

Step 3 In the **Calendar** area, select a date.

Step 4 In the **CAM NAME** list, select a channel.



Only single-channel supports this function.

Step 5 Start playing back splices. See Figure 4-103.

- Click , the playback starts from the beginning.
- Double-click anywhere on the time bar, the playback starts from where you click.

Figure 4-103



#### 4.6.7 File List



Click , system displays file list. It displays the first channel of the record. See Figure 4-104.

Figure 4-104

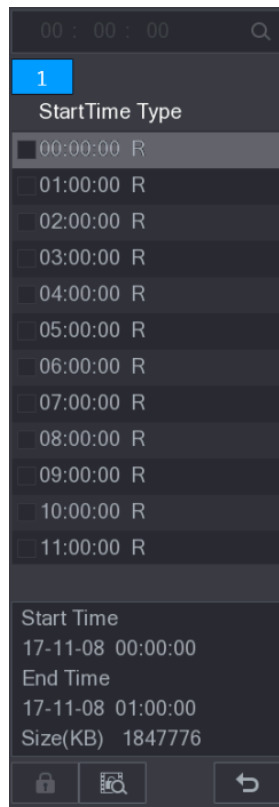

- Check a file name, double-click the file or click  to play.
- Input accurate time at the top column, you can search records of current day.
- System max displays 128 record files in one list.
- Click  to go back to the calendar/channel selection interface.

#### Lock or Unlock File



- To lock the recorded video, on the **File List** interface, select the check box of the recorded video, and then click . The locked video will not be overwritten.
- To view the locked information, click , the **FILE LOCKED** interface is displayed.  
  
The recorded video that is under writing or overwriting cannot be locked.
- To unlock the recorded video, in the **FILE LOCKED** interface, select the video, and then click **Unlock**. See Figure 4-105.

Figure 4-105



## 4.6.8 Other Aux Functions

### 4.6.8.1 Digital Zoom

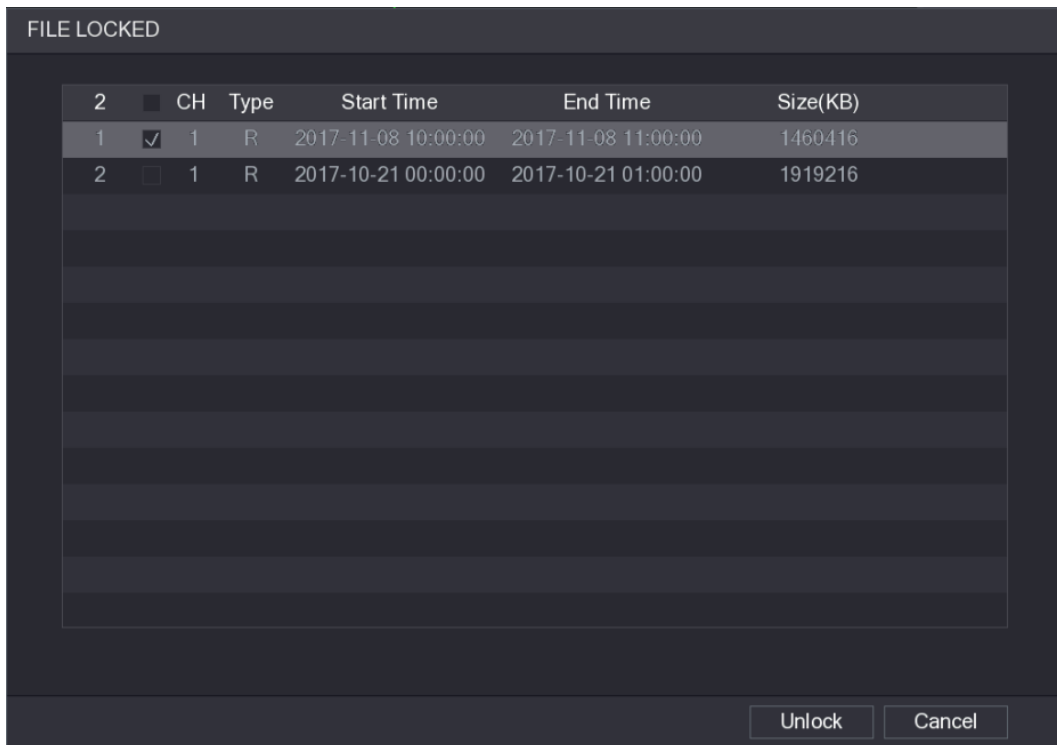
In 1-window playback mode, left click mouse to select any zone on the screen, you can zoom in current zone. Right click mouse to exit.

### 4.6.8.2 Switch Channel

- During playback mode, select from the dropdown list to switch playback channel.
- The smart search channel does not support this function either.
- When system is playing back the record file, click the number button at the front panel, system begins playing the record file of selected channel dated the same time.

## 4.7 AI

### 4.7.1 AI Search

You can search the record file on the NVR and filter the record file meets the corresponding rule. It is suitable for you to play the specified file.



This series NVR products support playback the AI by camera file only. AI by camera means the connected camera does all the AI analytics, and then gives the results to the NVR.

#### 4.7.1.1 Face Detection

You can search the detected faces and play back.

- Step 1** Select **Main Menu > AI > SMART SEARCH > FACE DETECTION**.  
The **FACE DETECTION** interface is displayed. See Figure 4-106.

Figure 4-106

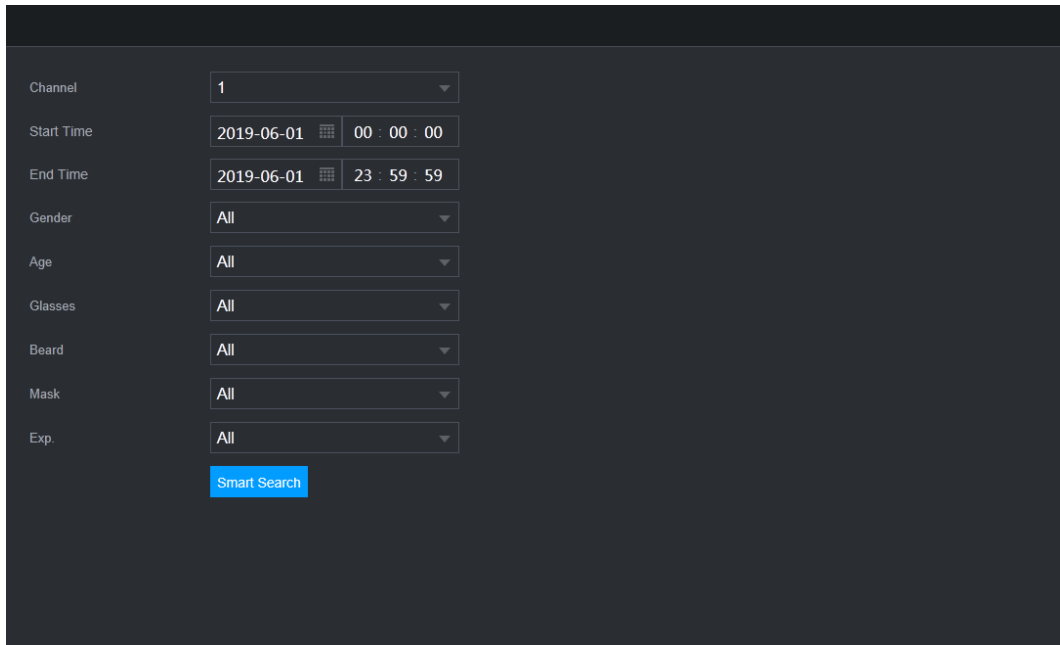

**Step 2** Select the channel, enter the start time and end time, and set for the gender, age, glasses, beard, and mask. Click **Smart Search**. The results are displayed. See Figure 4-107.



For privacy reason, the human face in the image is pixelated. The actual image is clear.

Figure 4-107

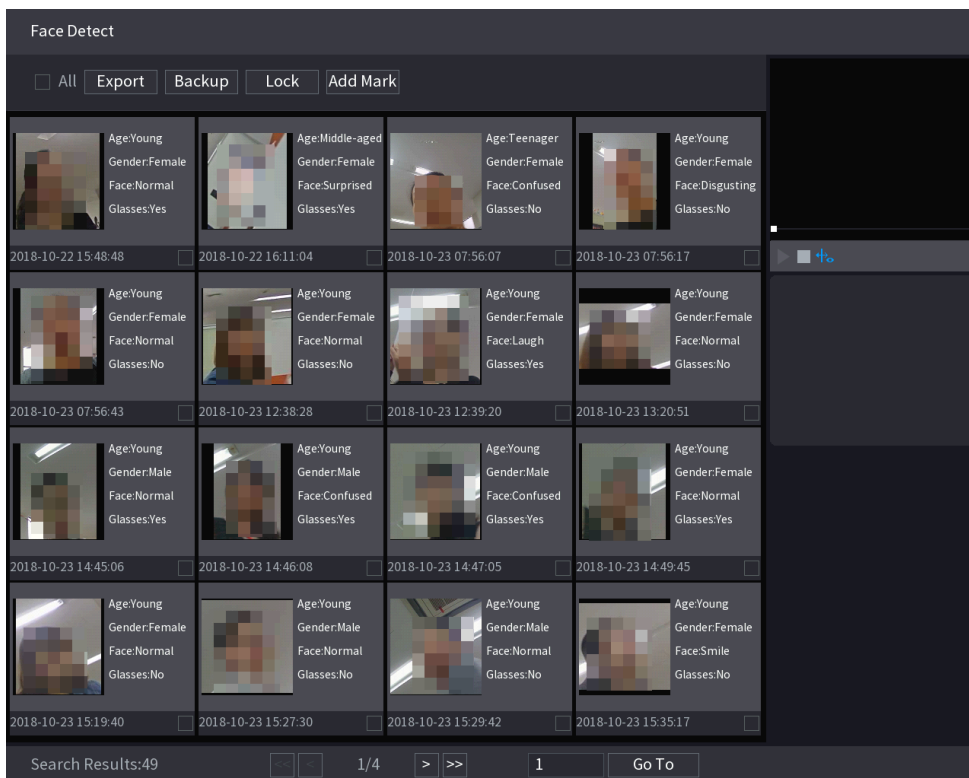

**Step 3** Select the face that you want to play back.  
The picture with registered information is displayed.  
You can also do the following operations to the recorded files.

- To back up the recorded files to the external storage device, select files, click **Backup**, select the save path and file type, and then click **Start**. See Figure 4-108.

Figure 4-108

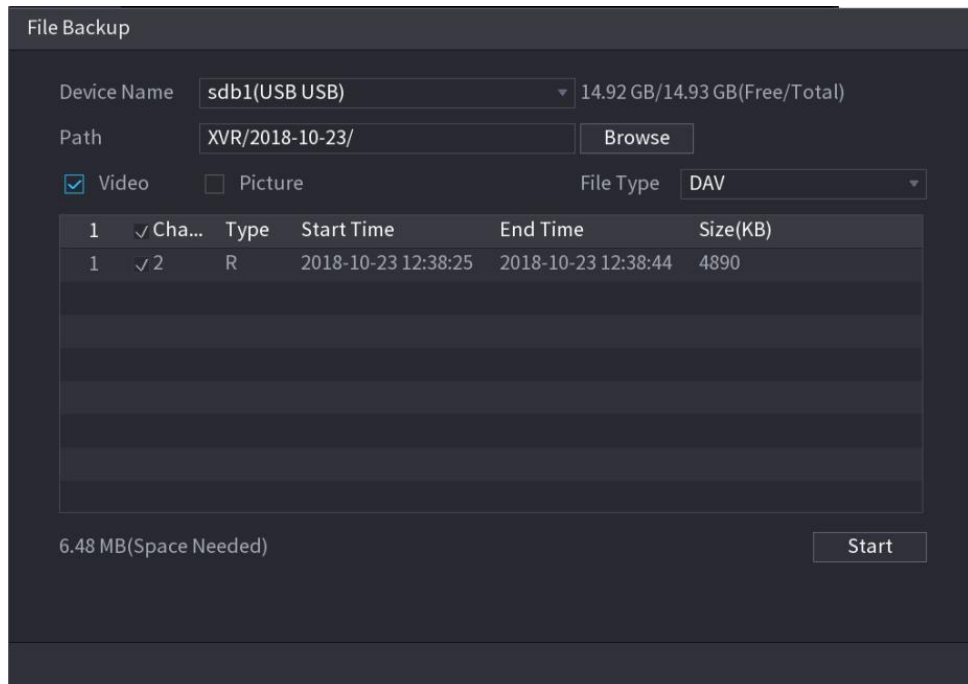

- To lock the files to make it unable to be overwritten, select the files, and then click **Lock**.
- To add a mark to the file, select the files and then click **Add Mark**.
- Go to **Face Properties** and **Person Details** to view detailed information.

#### 4.7.1.2 Face Recognition

System can search and compare the human face on the video with the face image on the database, and playback the corresponding record file.

The AI search includes two ways: Search by attributes and search by image.



This function is for some series products only.

##### 4.7.1.2.1 Searching by Attributes

Step 1 Select **Main Menu > AI > SMART SEARCH > FACE RECOGNITION > Search by Attributes**.

The **Search by Attributes** interface is displayed. See Figure 4-109.

Figure 4-109

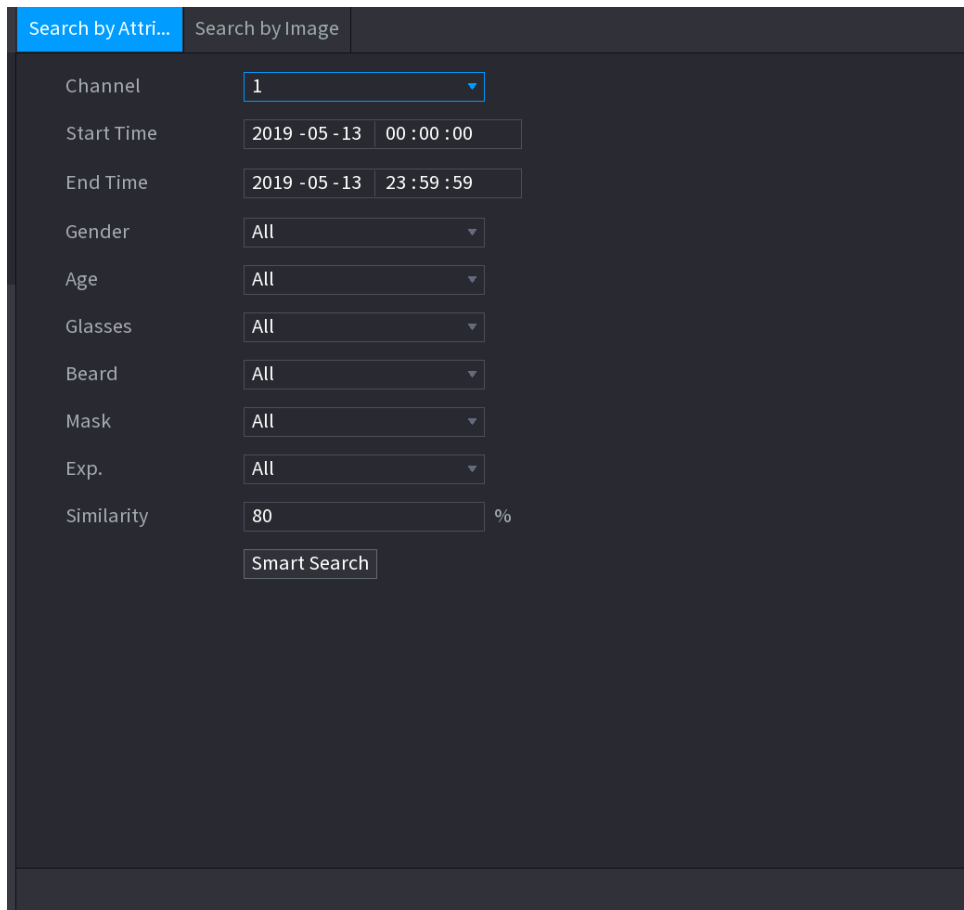

The screenshot shows a search interface with two tabs: "Search by Attri..." (highlighted in blue) and "Search by Image". Below the tabs are several filter fields:

- Channel: 1
- Start Time: 2019 -05 -13 00 :00 :00
- End Time: 2019 -05 -13 23 :59 :59
- Gender: All
- Age: All
- Glasses: All
- Beard: All
- Mask: All
- Exp.: All
- Similarity: 80 %

At the bottom of the filter section is a button labeled "Smart Search".

Step 2 Select the channel and set the parameters such as start time, end time, gender, age, glasses, beard, mask, and similarity according to your requirement.

Step 3 Click **Smart Search**.

The search result is displayed. See Figure 4-110.



The human face in the image is pixelated. The actual image is clear.

Figure 4-110

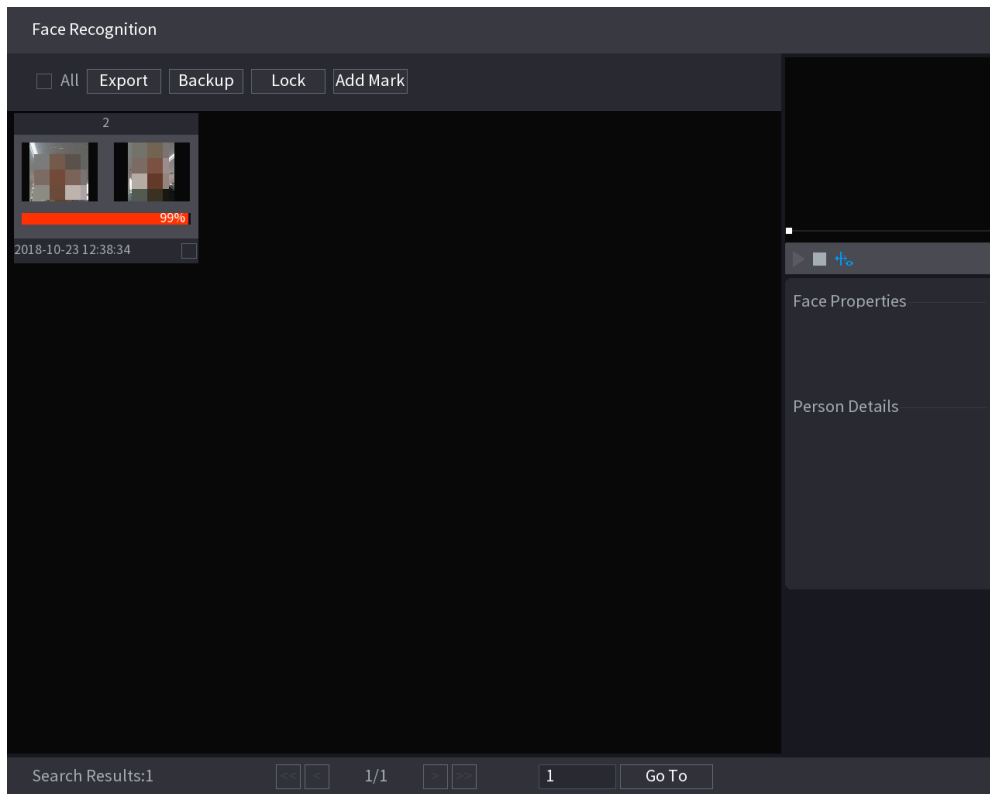

**Step 4** Click the picture that you want to play back.

The picture with registered information is displayed.

You can also do the following operations to the recorded files.

- To back up the recorded files to the external storage device, select files, click **Backup**, select the save path and file type, and then click **Start**. See .
- To lock the files to make it unable to be overwritten, select the files, and then click **Lock**.
- To add a mark to the file, select the files and then click **Add Mark**.
- Go to the **Face Properties** and **Person Details** to view detailed information.

#### 4.7.1.2.2 Search by Image

**Step 1** Select **Main Menu > AI > SMART SEARCH > FACE RECOGNITION > Search by Image**.

The **Search by Image** interface is displayed. See Figure 4-111.

Figure 4-111

Search by Attri... Search by Image

Face Library Local Upload \*Max. upload 30 images.\* Clear 0/0

Channel 1

Start Time 2019-05-13 00:00:00

End Time 2019-05-13 23:59:59

Similarity 80 % (50%~100%)

Smart Search

Step 2 Select the channel and set the parameters such as start time, end time, gender, age, glasses, beard, mask, and similarity according to your requirement.

Step 3 Click **Smart Search**.

The search result is displayed. See Figure 4-112.



The human face in the image is pixelated. The actual image is clear.



Figure 4-112

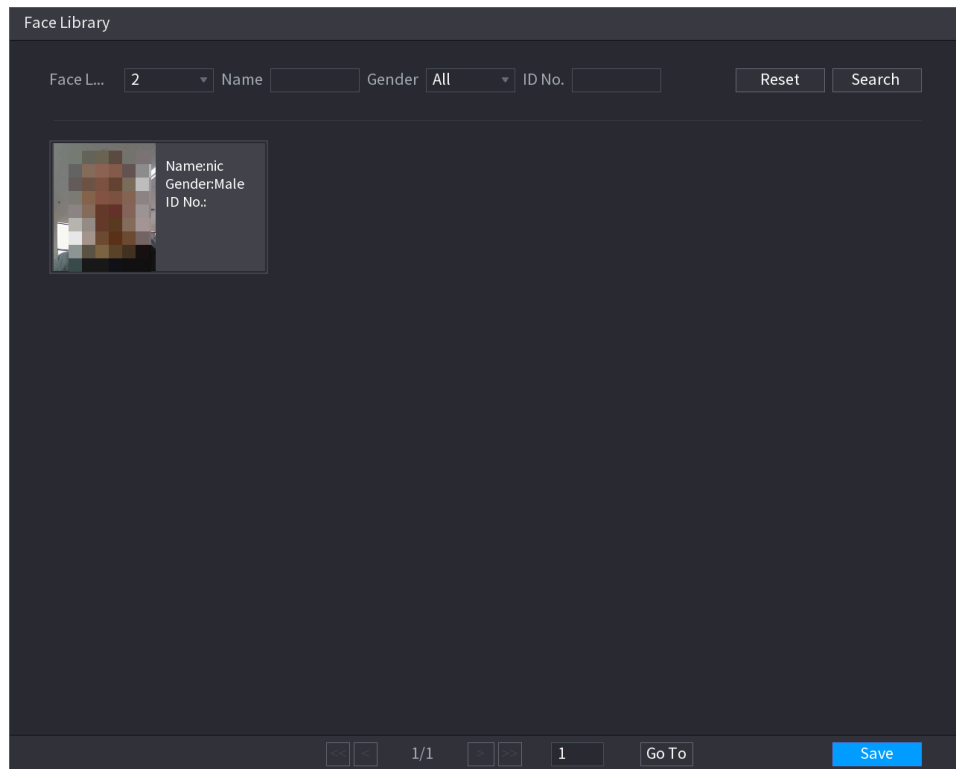

**Step 4** Click the picture that you want to play back.

The picture with registered information is displayed.

You can also do the following operations to the recorded files.

- To back up the recorded files to the external storage device, select files, click **Backup**, select the save path and file type, and then click **Start**.
- To lock the files to make it unable to be overwritten, select the files, and then click **Lock**.
- To add a mark to the file, select the files and then click **Add Mark**.
- Go to the **Face Properties** and **Person Details** to view detailed information.

#### 4.7.1.3 IVS

You can search and playback the alarm record files.

**Step 1** Select **Main Menu > AI > SMART SEARCH > IVS**.

The **IVS** interface is displayed. See Figure 4-113.

Figure 4-113

The screenshot shows a search configuration interface with the following fields and options:

- Channel:** A dropdown menu set to '1'.
- Start Time:** A date and time selector set to '2019-06-01 00 : 00 : 00'.
- End Time:** A date and time selector set to '2019-06-01 23 : 59 : 59'.
- Event Type:** A dropdown menu set to 'All'.
- Effective Target:** Three checkboxes labeled 'Person', 'Vehicle', and 'Non-Motor', all of which are currently unchecked.
- Smart Search:** A prominent blue button located below the checkboxes.

**Step 2** Select a channel, start time, end time, event type, and then click Smart search, The search result is displayed.

**Step 3** Click the picture that you want to play back.

You can also do the following operations to the recorded files.

- To back up the recorded files to the external storage device, select files, click **Backup**, select the save path and file type, and then click **Start**.
- To lock the files to make it unable to be overwritten, select the files, and then click **Lock**.
- To add a mark to the file, select the files and then click **Add Mark**.
- Go to the **Face Properties** and **Person Details** to view detailed information.

#### 4.7.1.4 Human Body Detection

You can search the human body and search the alarm record during the specified period.

**Step 1** Select **Main Menu > AI > SMART SEARCH > HUMAN BODY DETECTION**. The **Human Body Detection** interface is displayed. See Figure 4-114.

Figure 4-114

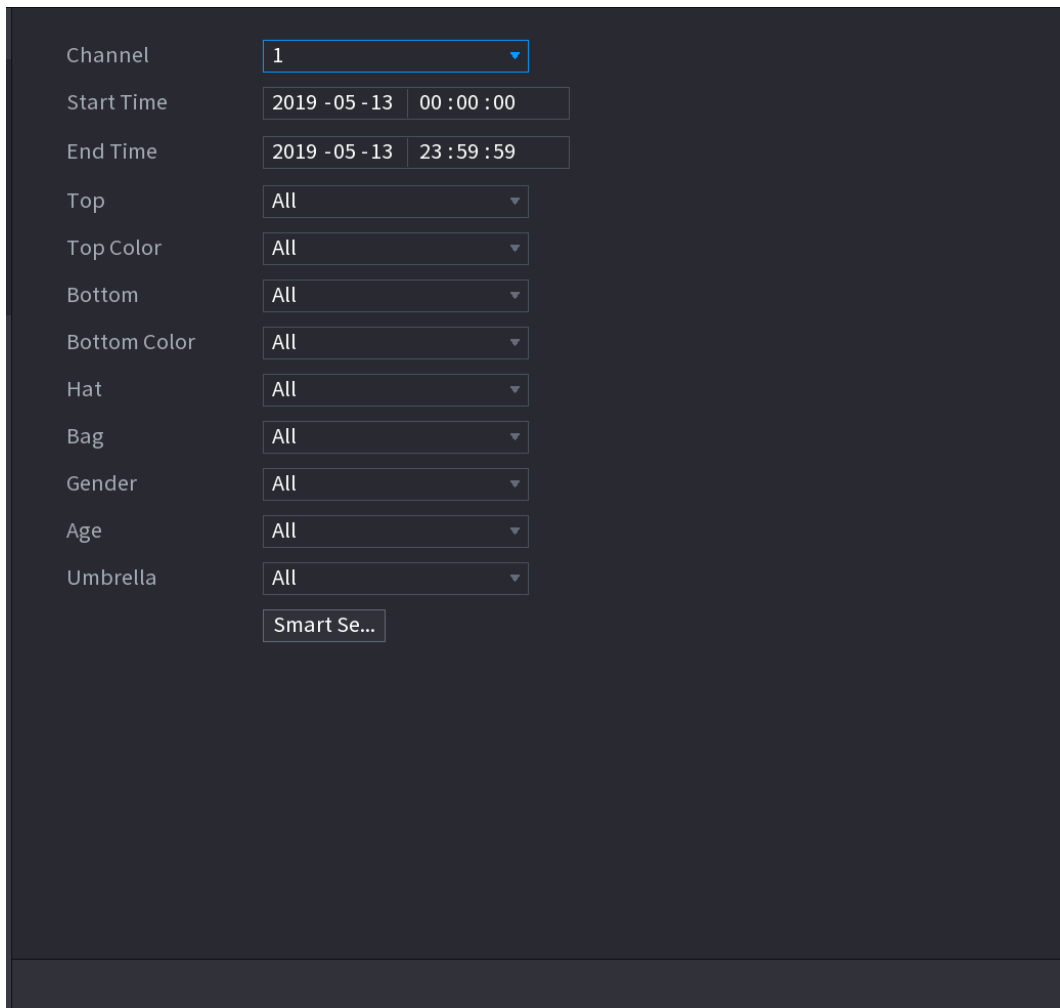

The screenshot shows a search filter interface with the following fields:

Channel	1
Start Time	2019 -05 -13 00 :00 :00
End Time	2019 -05 -13 23 :59 :59
Top	All
Top Color	All
Bottom	All
Bottom Color	All
Hat	All
Bag	All
Gender	All
Age	All
Umbrella	All
	Smart Se...

Step 2 Select a channel, start time, end time, and set corresponding parameters.

Step 3 Click **Smart search**.

The search result is displayed. See Figure 4-115.



For privacy reason, the human face in the image is pixelated.

Figure 4-115

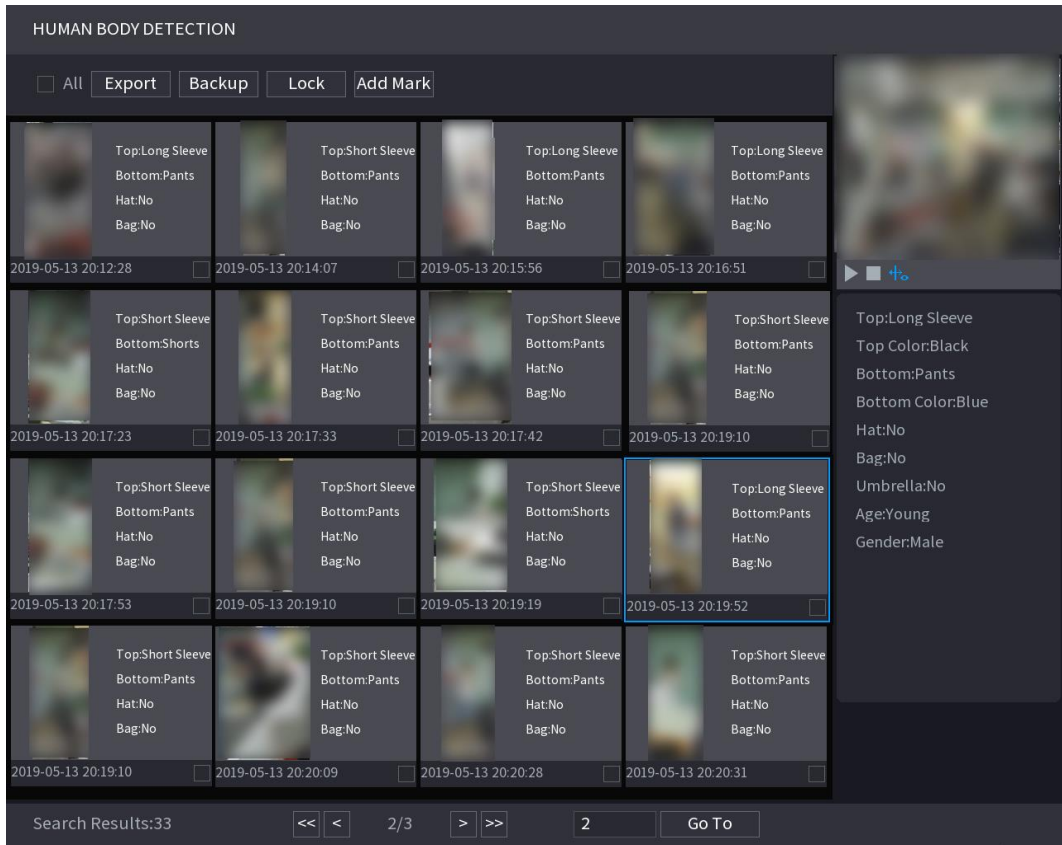

**Step 4** Select one or multiple results, and then you can

- To back up the recorded files to the external storage device, select files, click **Backup**, select the save path and file type, and then click **Start**.
- To lock the files to make it unable to be overwritten, select the files, and then click **Lock**.
- To add a mark to the file, select the files and then click **Add Mark**.
- Go to the **Face Properties** and **Person Details** to view detailed information.

#### 4.7.1.5 Vehicle Detection

You can search according to the vehicle parameters and search the alarm record during the specified period.



This function is for some series products only.

**Step 1** Select **Main Menu > AI > SMART SEARCH > VEHICLE DETECTION**.

The **VEHICLE DETECTION** interface is displayed. See Figure 4-116.

Figure 4-116

The screenshot shows a search configuration interface with the following fields:

Channel	1
Start Time	2019-06-01 00 : 00 : 00
End Time	2019-06-01 23 : 59 : 59
Plate No.	All
Vehicle Color	All
Type	All
Logo	All
Plate Color	All
Ornament	All
Calling	All
Seatbelt	All

Smart Search

Step 2 Select a channel and set parameters.



- System supports plate fuzzy search.
- System searches all plate numbers by default if you have not set a plate number.

Step 3 Click Smart search.

The search result is displayed.

Step 4 Select one or multiple results, and then you can:

- To back up the recorded files to the external storage device, select files, click **Backup**, select the save path and file type, and then click **Start**.
- To lock the files to make it unable to be overwritten, select the files, and then click **Lock**.
- To add a mark to the file, select the files and then click **Add Mark**.

#### 4.7.1.6 Non-motor Vehicle Detection

You can search according to the non-motor vehicle parameters and search the alarm record during the specified period.



This function is for some series products only.

Step 1 Select **Main Menu > AI > SMART SEARCH > NON-MOTOR VEHICLE DETECTION**.

The **NON-MOTOR VEHICLE DETECTION** interface is displayed. See Figure 4-117.

Figure 4-117

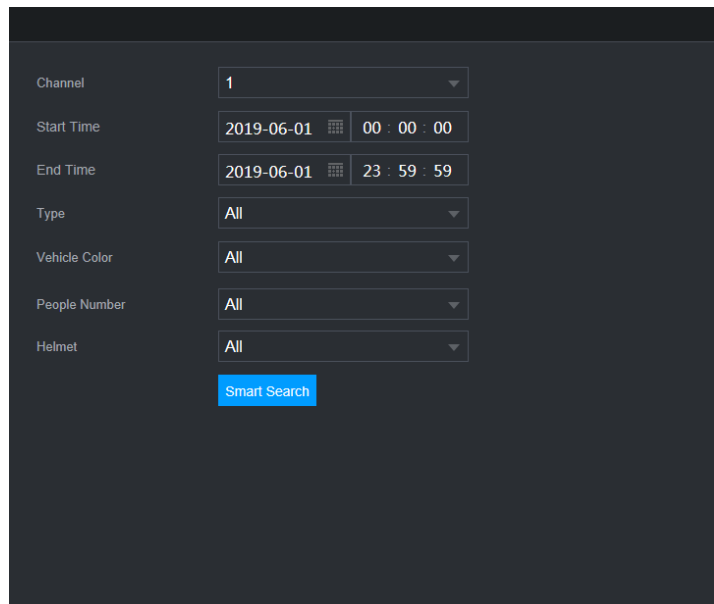

**Step 2** Select the channel and the time, and then select one or multiple features from **Type**, **Vehicle Color**, **People Number**, or **Helmet**.

**Step 3** Click **Smart Search**.

The search result is displayed. See Figure 4-118.

Figure 4-118

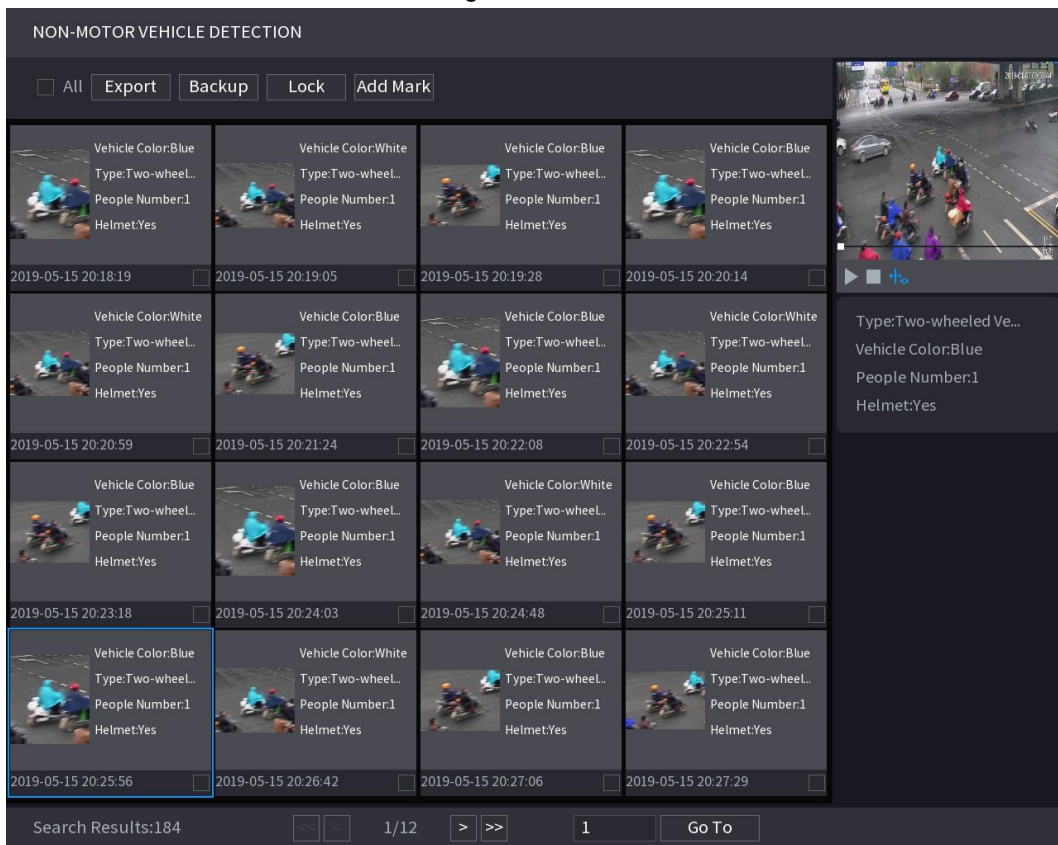

**Step 4** Select one or multiple results, and then you can

- To back up the recorded files to the external storage device, select files, click **Backup**, select the save path and file type, and then click **Start**.
- To lock the files to make it unable to be overwritten, select the files, and then click **Lock**.
- To add a mark to the file, select the files and then click **Add Mark**.

#### 4.7.1.7 People Counting

You can detect the people amount in the specified zone, and display the statistics image.

**Step 1** Select **Main Menu > AI > SMART SEARCH > PEOPLE COUNTING**.  
The **PEOPLE COUNTING** interface is displayed. See Figure 4-119.

Figure 4-119

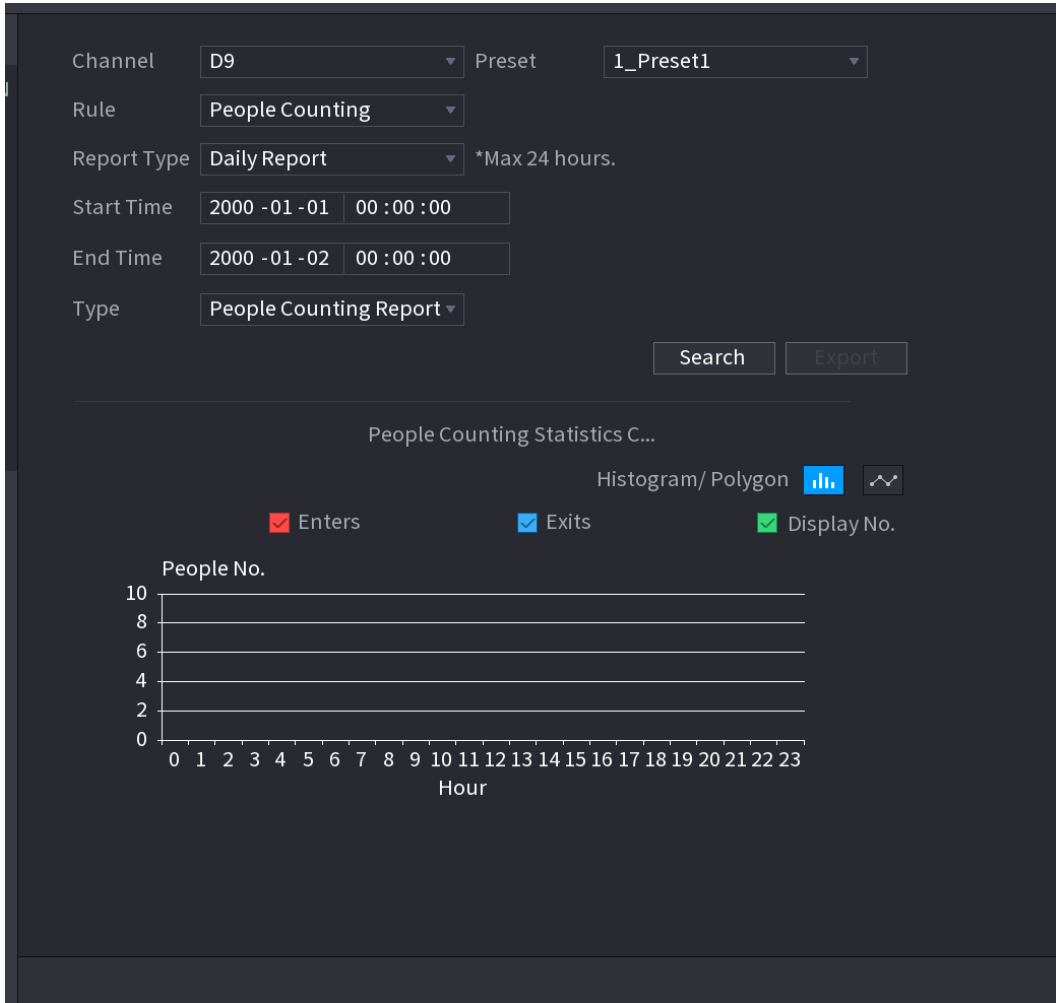

**Step 2** Set parameters such as channel, report type, start time, end time, etc. See Table 4-25.

Table 4-25

Parameter	Description
Channel	Select the channel you want to search people amount.
Rule	Select the rule from the dropdown list.
Report Type	Select report type from the dropdown list: daily report, monthly report, yearly report.
Start time/end time	Set search start time and end time.
Type	Select from the dropdown list.

#### 4.7.1.8 Heat map

You can detect the active objects distribution in the monitor zone during the specified period, and use different colors to display on the heat map report.

##### 4.7.1.8.1 Normal

**Step 1** Select **Main Menu > AI > SMART SEARCH > HEAT MAP > NORMAL**.  
The **Normal** interface is displayed. See Figure 4-120.

Figure 4-120

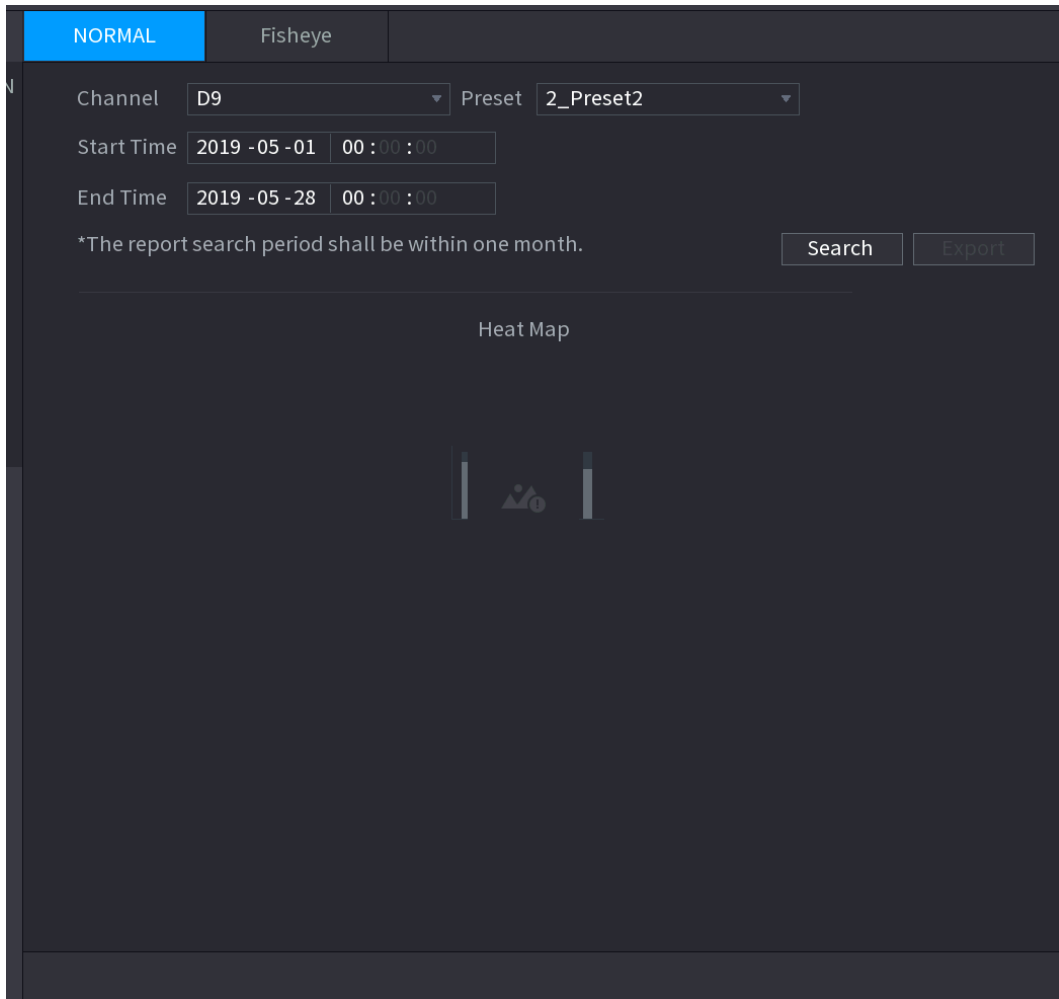

Step 2 Select channel, start time, end time.

Step 3 Click **Search**.

Step 4 System display heat map report.



Click **Export**, and then select path. Click Save to save current report to the USB device.

#### 4.7.1.8.2 Fisheye

Step 1 Select **Main Menu > AI > SMART SEARCH > HEAT MAP > Fisheye**.

The **Fisheye** interface is displayed. See Figure 4-121.



Figure 4-121

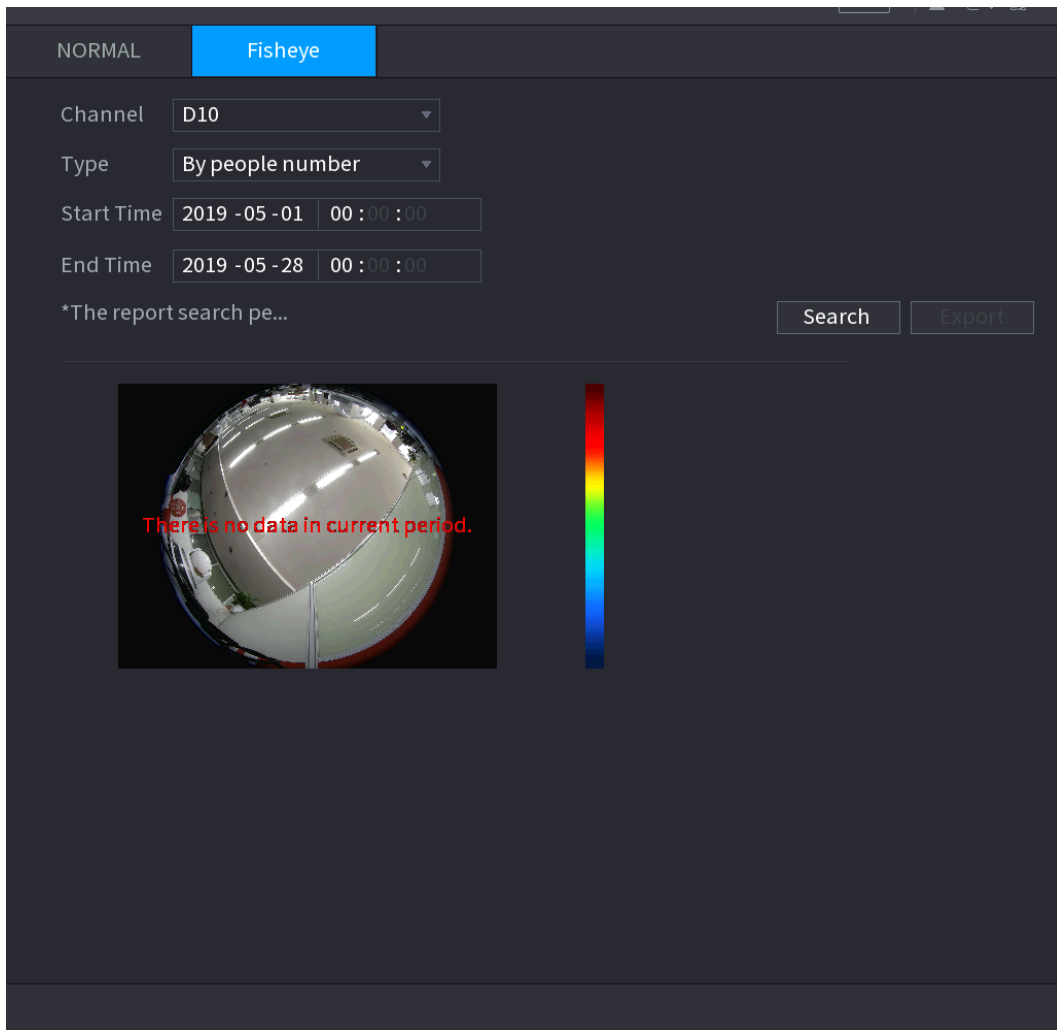

Step 2 Set **Channel**, **Type**, **Start Time**, **End time**.

Step 3 Click **Search**.

Step 4 System displays heat map report.



Click **Export** and then select saved path, click **Save** to save the heat map report to the USB device.

## 4.7.2 Parameters

### 4.7.2.1 Smart Plan

The smart plan is for the smart network camera. It includes IVS, human face detection, human face recognition, human body detection, people counting, heat map. If you do not set a rule here, you cannot use these AI intelligent functions when you are connecting to a smart network camera.

This series NVR products support AI by camera only. Make sure the connected network camera supports intelligent functions. For NVR, it just displays the intelligent alarm information from the smart network camera and set or playback the record file.

Step 1 Select **Main menu > AI > PARAMETERS > SMART PLAN**.  
The **SMART PLAN** interface is displayed. See Figure 4-122.

Figure 4-122

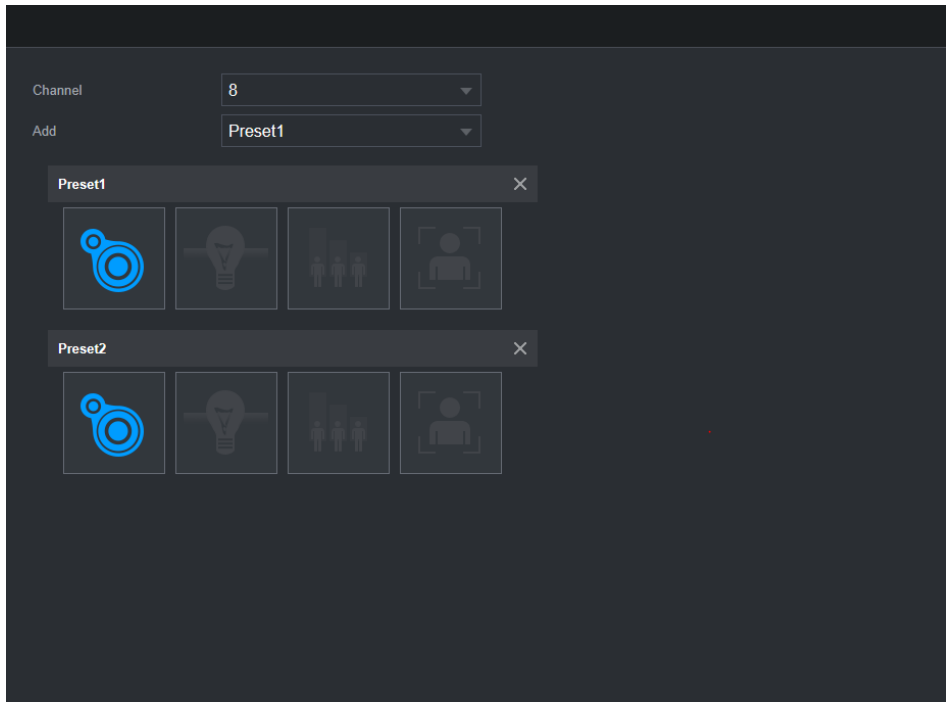

- Step 2** Select a channel number.  
System displays different smart plan interfaces since the remote device may supports different functions.
- The interface is shown as Figure 4-123 if the remote device supports preset function.

Figure 4-123

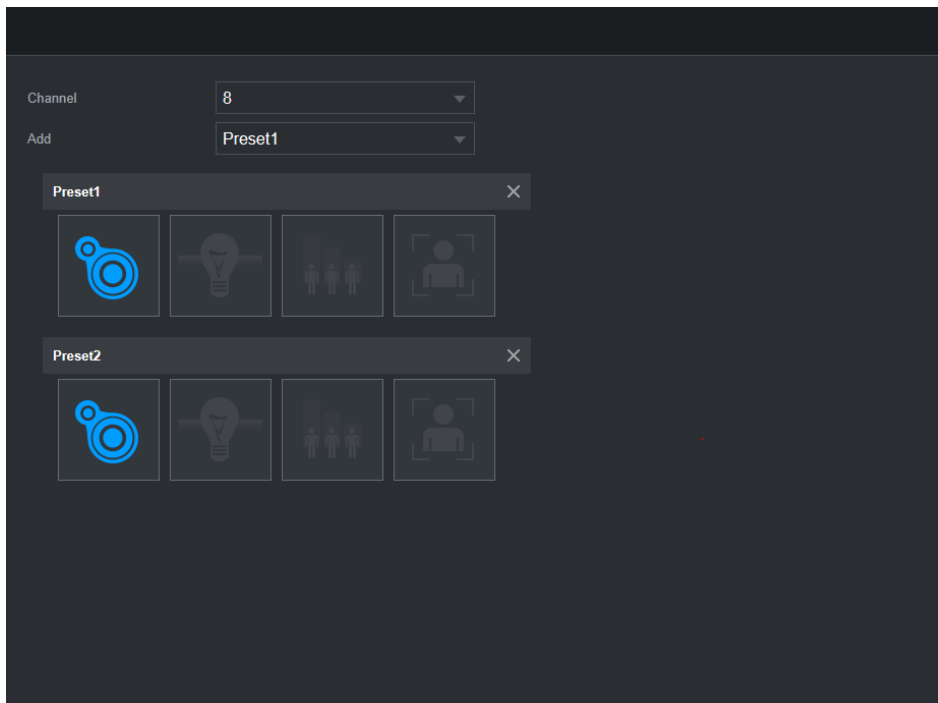

- 1) Select a channel.
- 2) Select a preset.
- 3) Click the smart plan icon at the bottom left. The icon becomes highlighted.
- 4) Click **Apply**.



- Click  to delete the preset.
- Click **Add** to add a preset.

- Once the remote device does not support preset function, the interface is shown as in Figure 4-124.

Figure 4-124

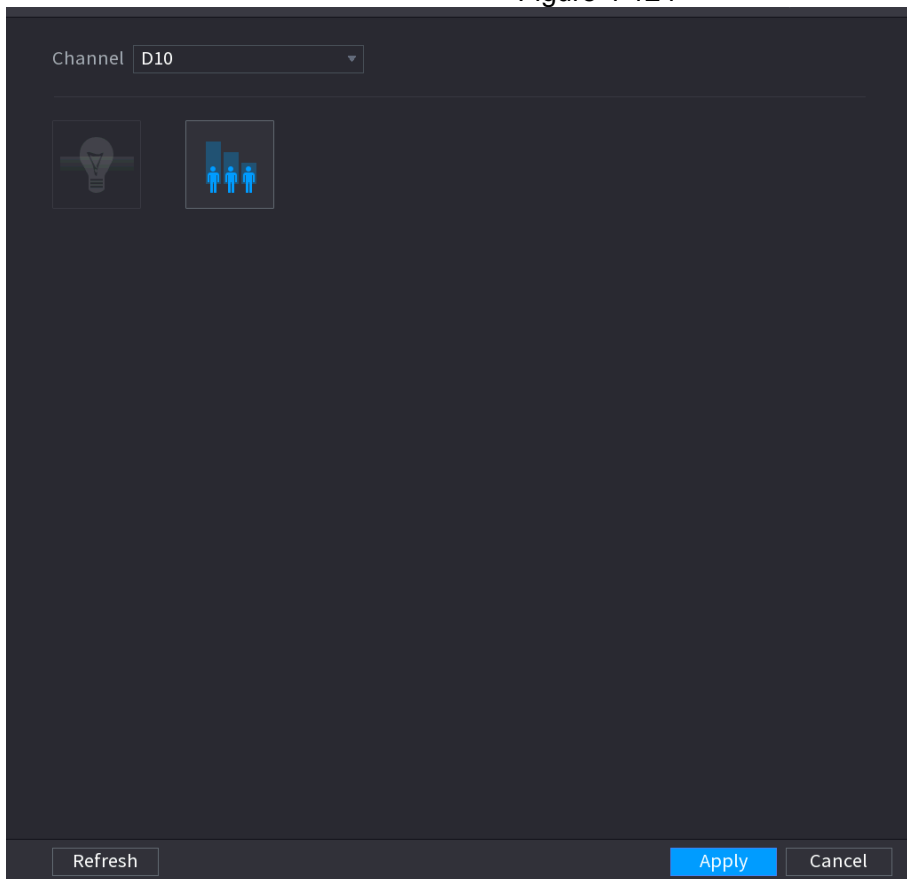

- 1) Select a channel.
- 2) Click the smart plan icon. The icon becomes blue highlighted.
- 3) Click **Apply**.

#### 4.7.2.2 Face Detection

The Device can analyze the pictures captured by the camera to detect whether the faces are on the pictures. You can search and filter the recorded videos the faces and play back.

### Preparations

The connected camera shall support human face detection function.

- Step 1 Select **Main Menu > AI > PARAMETERS > FACE DETECTION**.  
The **FACE DETECTION** interface is displayed. See Figure 4-125.

Figure 4-125

Channel: D2 Type: AI by Camera

Enable:  Rule: Setting

Face ROI:

Period: Setting

Alarm Out: Setting Latch: 0 Sec.

Alarm Upload  Send Email

Record Channel: Setting

PTZ Activation: Setting Post-Record: 10 Sec.

Tour: Setting

Buzzer  Log

Voice Prompts: None







Default Refresh Apply Back

**Step 2** In the **Channel** list, select a channel that you want to configure face detection function, and then enable it.

**Step 3** Configure the parameters. See Table 4-26.

Table 4-26

Parameter	Description
Type	This series NVR products support AI by Camera only. AI by Camera means the connected camera does all the AI analytics, and then gives the results to the NVR.
Face Rol	Check the box to enable Face Rol function, system displays human face at the enhanced way.
Rule	Click <b>Setting</b> to draw areas to filter the target. You can configure two filtering targets (maximum size and minimum size). When the target is smaller than the minimum size or larger than the maximum size, no alarms will be activated. The maximum size should be larger than the minimum size. Left click to drag the four angles to adjust the size.
Period	Configure the period and in the set time range, the corresponding configuration item will be linked to start the alarm.
Alarm Out	The alarm device (such as lights, sirens, etc.) is connected to the alarm output port. When an alarm occurs, the NVR device transmits the alarm information to the alarm device.
Latch	When the alarm ends, the alarm extended for a period of time. The time range is from 0 seconds to 300 seconds.

Parameter	Description
Alarm Upload	Select the check box. When an alarm occurs, the NVR device uploads an alarm signal to the network (including the alarm center).  <ul style="list-style-type: none"> <li>This function is for some series products only.</li> <li>You need to set the alarm center first. For details, see "4.12.11 Alarm Cente."</li> </ul>
Send Email	Select the check box. When an alarm occurs, the NVR device sends an email to the set mailbox to notify the user.  You need to set the email first. For details, see "4.12.8 Email."
Record Channel	Select the check box and select the needed recording channel (support multiple choices). When an alarm occurs, the NVR device activates the channel for recording.  You need to enable intelligent recording and auto recording first. For details, see "4.1.4.6 Schedule."
PTZ Activation	Select the check box and click <b>Setting</b> to select the channel and PTZ action. When an alarm occurs, the NVR device associates the channel to perform the corresponding PTZ action. For example, activate the PTZ in channel one to turn to the preset point X.  <ul style="list-style-type: none"> <li>Tripwire alarm supports to activate PTZ preset point only.</li> <li>You need to set the corresponding PTZ actions first, see "4.4.3 Configuring PTZ Functions."</li> </ul>
Delay	At the end of the alarm, the recording extends for a period of time. The time range is from 10 seconds to 300 seconds.
Tour	Select the check box and select the channel for tour. When an alarm occurs, the local interface of the NVR device displays the selected channel screen.  <ul style="list-style-type: none"> <li>You need to set the time interval and mode for tour first, see "4.17.2 Tour. "</li> <li>After the tour is over, the preview interface is restored to the screen split mode before the tour.</li> </ul>
Log	Select the check box, the NVR device records the alarm information in the log when an alarm occurs.
Voice Prompts	Check the box and then select the corresponding audio file from the dropdown list. System plays the audio file when the alarm occurs.  Refer to "4.18.1 File Manage " to add audio file first.
Buzzer	Select the check box to activate the buzzer when an alarm occurs.

**Step 4** Click **Apply** to complete the settings.

#### 4.7.2.3 Face Recognition

You can compare the detected faces with the faces in the library to judge if the detected face belongs to the library. The comparison result will be displayed on the AI mode live view screen and smart search interface, and link the alarms.

This series NVR products support AI by camera only.

You can use the connected camera to realize AI function. Make sure the connected camera supports human face detection function.

**Step 1** Select **Main Menu > AI > PARAMETERS > FACE RECOGNITION**.

The **FACE RECOGNITION** interface is displayed. See Figure 4-126.

Figure 4-126

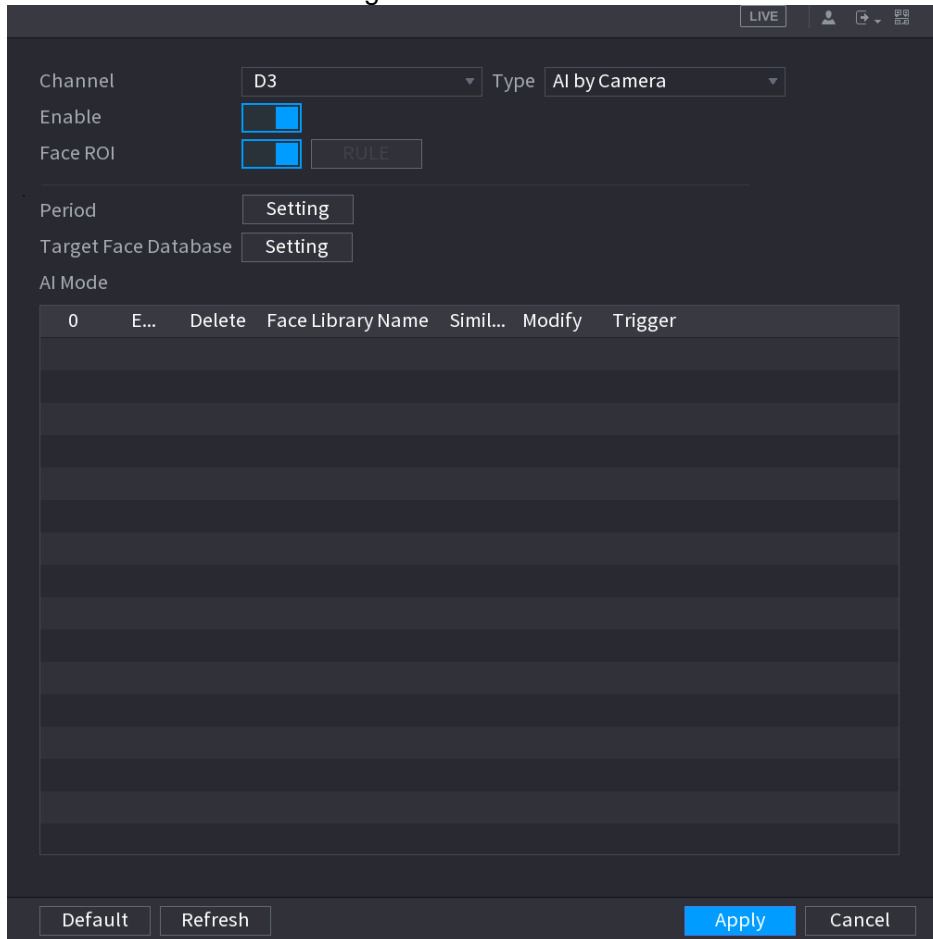

**Step 2** In the **Channel** list, select a channel that you want to configure face recognition function, and then enable it.

**Step 3** At **Type**, system supports **AI by Camera** only.

**Step 4** Set parameters. See Table 4-27.

Table 4-27

Parameter	Description
Rol	Check the box to enable Rol function, system displays human face at the enhanced way.
Rule	Click <b>Setting</b> to draw areas to filter the target. You can configure two filtering targets (maximum size and minimum size). When the target is smaller than the minimum size or larger than the maximum size, no alarms will be activated. The maximum size should be larger than the minimum size. Left click to drag the four angles to adjust the size.
Period	Configure the period and in the set time range, the corresponding configuration item will be linked to start the alarm.
Target Face Database	Click Target Face Database, system displays face database list. Select a database from the dropdown list to compare.

**Step 5** Set the **Target Face Database**.

**Step 6** (Optional) Click  to modify the similarity. The lower the number is, the easier the alarm linkage will trigger.

**Step 7** Click  to set the alarm linkage. See Figure 4-127.









Refer to "4.7.3 Database" for human target database settings information.

Figure 4-127

**Step 8** Configure the parameters. See Table 4-28.

Table 4-28

Parameter	Description
Period	Configure the period and in the set time range, the corresponding configuration item will be linked to start the alarm.
Alarm Out	The alarm device (such as lights, sirens, etc.) is connected to the alarm output port. When an alarm occurs, the NVR device transmits the alarm information to the alarm device.
Latch	When the alarm ends, the alarm extended for a period of time. The time range is from 0 seconds to 300 seconds.
Alarm Upload	Select the check box. When an alarm occurs, the NVR device uploads an alarm signal to the network (including the alarm center).  <ul style="list-style-type: none"> <li>This function is for some series products only.</li> <li>You need to set the alarm center first. For details, see "4.12.11 Alarm Cente."</li> </ul>
Send Email	Select the check box. When an alarm occurs, the NVR device sends an email to the set mailbox to notify the user.  <p>You need to set the email first. For details, see "4.12.8 Email."</p>
Record Channel	Select the check box and select the needed recording channel (support multiple choices). When an alarm occurs, the NVR device activates the channel for recording.  <p>You need to enable intelligent recording and auto recording first. For details, see "4.1.4.6 Schedule."</p>
PTZ Activation	Select the check box and click <b>Setting</b> to select the channel and PTZ action. When an alarm occurs, the NVR device associates the channel to perform the corresponding PTZ action. For example, activate the PTZ in channel one to turn to the preset point X.  <ul style="list-style-type: none"> <li>Tripwire alarm supports to activate PTZ preset point only.</li> <li>You need to set the corresponding PTZ actions first, see "4.4.3 Configuring PTZ Functions."</li> </ul>

Parameter	Description
Delay	At the end of the alarm, the recording extends for a period of time. The time range is from 10 seconds to 300 seconds.
Tour	Select the check box and select the channel for tour. When an alarm occurs, the local interface of the NVR device displays the selected channel screen.  <ul style="list-style-type: none"> <li>You need to set the time interval and mode for tour first, see "4.17.2 Tour. "</li> <li>After the tour is over, the preview interface is restored to the screen split mode before the tour.</li> </ul>
Log	Select the check box, the NVR device records the alarm information in the log when an alarm occurs.
Voice Prompts	Check the box and then select the corresponding audio file from the dropdown list. System plays the audio file when the alarm occurs.  <p>Refer to "4.18.1 File Manage " to add audio file first.</p>
Buzzer	Select the check box to activate the buzzer when an alarm occurs.

**Step 9** Click **OK**, system goes back to human face recognition interface.

**Step 10** Click **Apply** to complete the settings.

The interface is shown as Figure 4-128 if there is matched result.

Figure 4-128

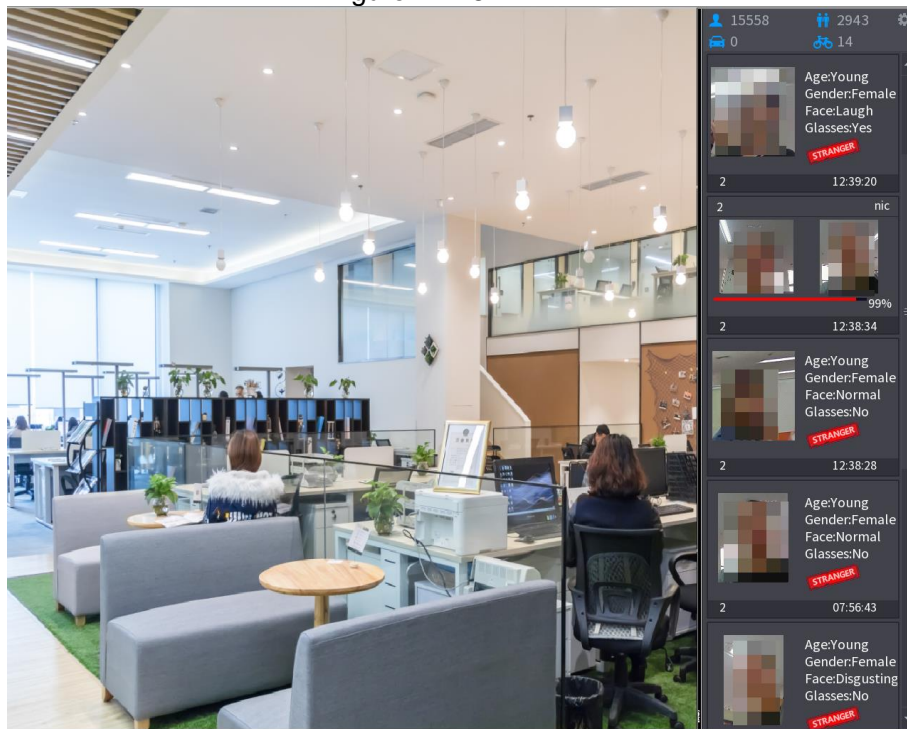

#### 4.7.2.4 IVS (General Behavior Analytics)

The IVS function processes and analyzes the images to extract the key information to match with the specified rules. When the detected behaviors match with the rules, the system activates alarms.



- This function is for some series product only.
- IVS function and human face detection function cannot be valid at the same time.

The IVS function environment shall meet the following requirements:

- The object total size shall not be more than 10% of the whole video.
- The object size on the video shall not be more than 10pixels\*10 pixels. The abandoned object size shall be more than 15pixels\*15 pixels (CIF resolution). The object width shall not be more than 1/3 of the video height and width. The recommended height is 10% of the



video.

- The object and the background brightness different shall be more than 10 grey levels.
- The object shall remain on the video for more than 2 seconds. The moving distance is larger than its own width and shall not be smaller than 15pixels (CIF resolution).
- The surveillance environment shall not be too complicated. The IVS function is not suitable for the environment of too many objects or the changing light.
- The surveillance environment shall not contain glasses, reflection light from the ground, and water. Free of tree branches, shadow, mosquito and bugs. Do not use the IVS function in the backlight environment, avoid direct sunlight.

**Step 1** Select **Main Menu > AI > PARAMETERS > IVS**.  
The **IVS** interface is displayed. See Figure 4-129.

Figure 4-129

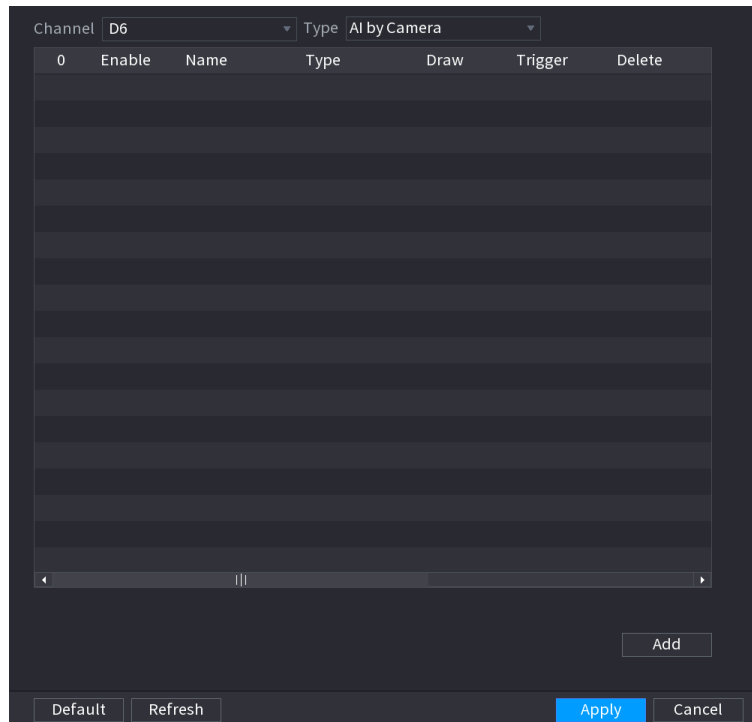

**Step 2** Select a channel from the dropdown list.  
Click **Add** and then set corresponding rule. See Figure 4-130.



Click  to delete the selected rule.

Figure 4-130

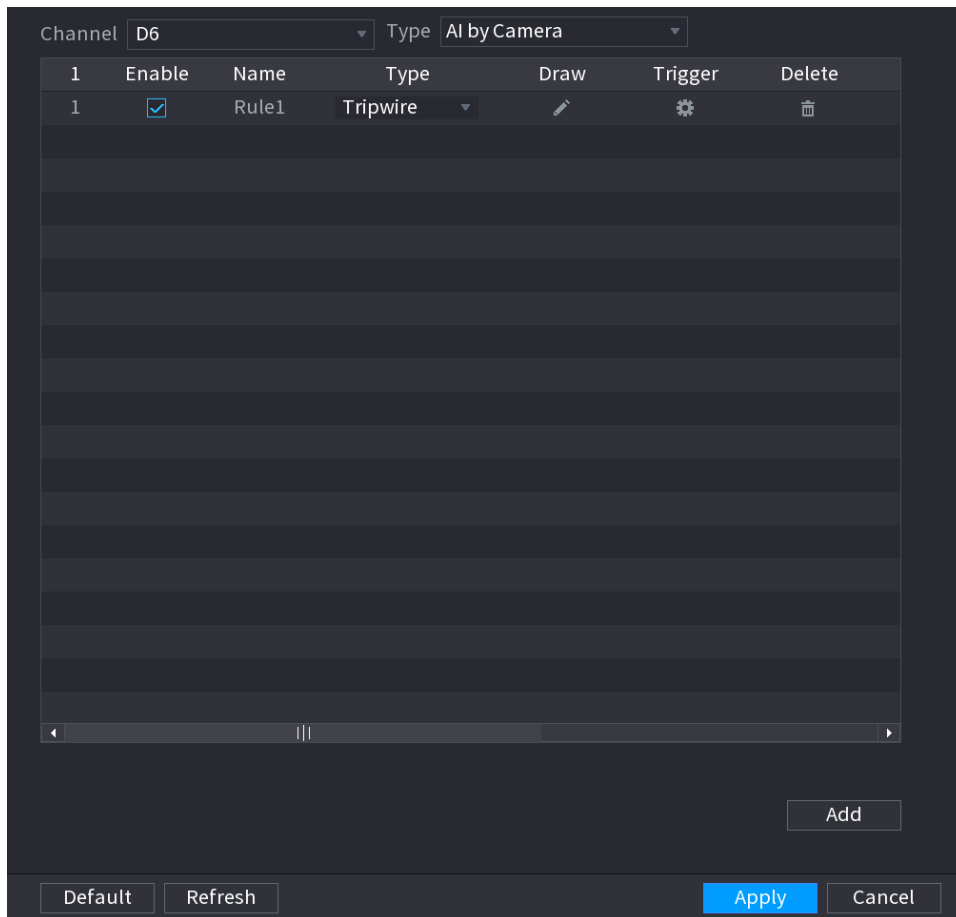

Step 3 Set corresponding parameters.

Step 4 Click **Apply**.

#### 4.7.2.4.1 Tripwire

When the detection target crosses the warning line along the set direction, the system performs an alarm linkage action.

Step 1 Select **Main Menu > AI > PARAMETERS > IVS**.

In the **Type** drop-down list, select **Tripwire**. See Figure 4-131.

Figure 4-131

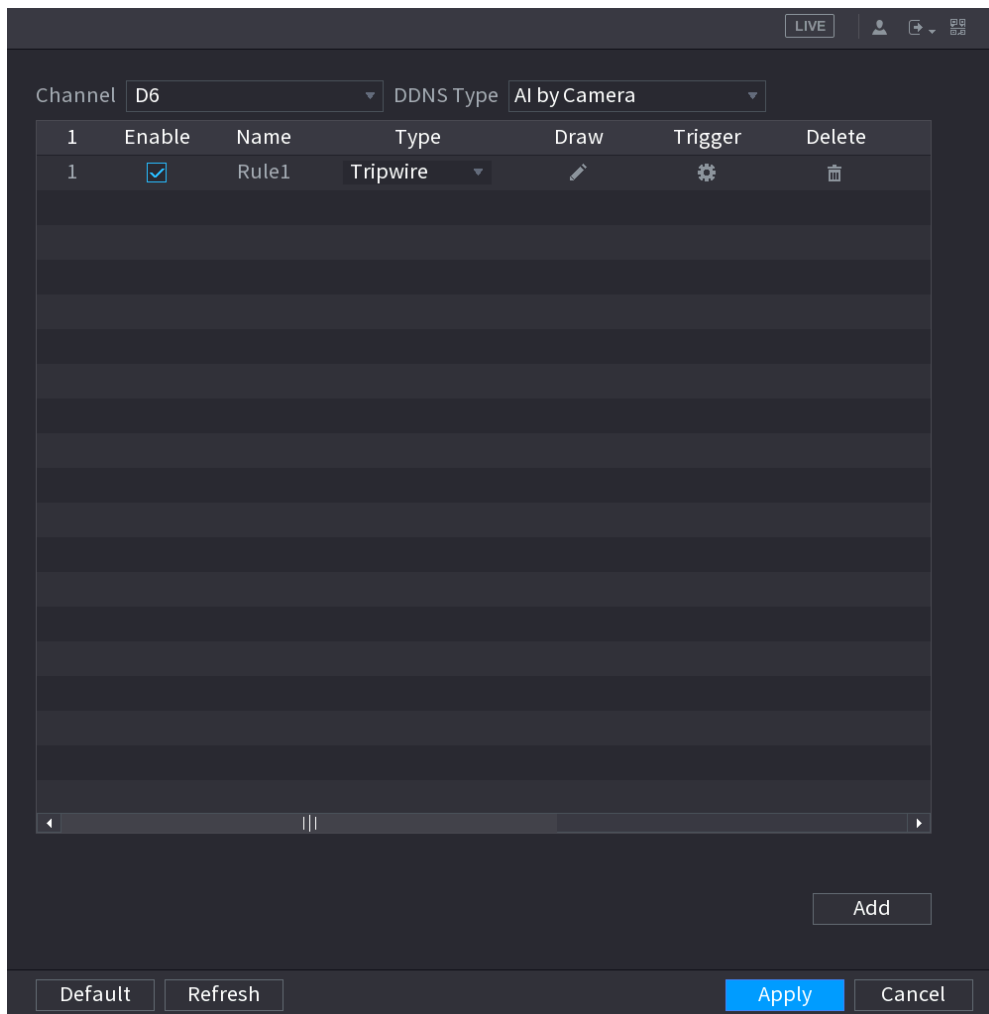

**Step 2** Draw the detection rule.





- 1) Click  to draw the rule on the surveillance video, the system displays as Figure 4-132.

Figure 4-132

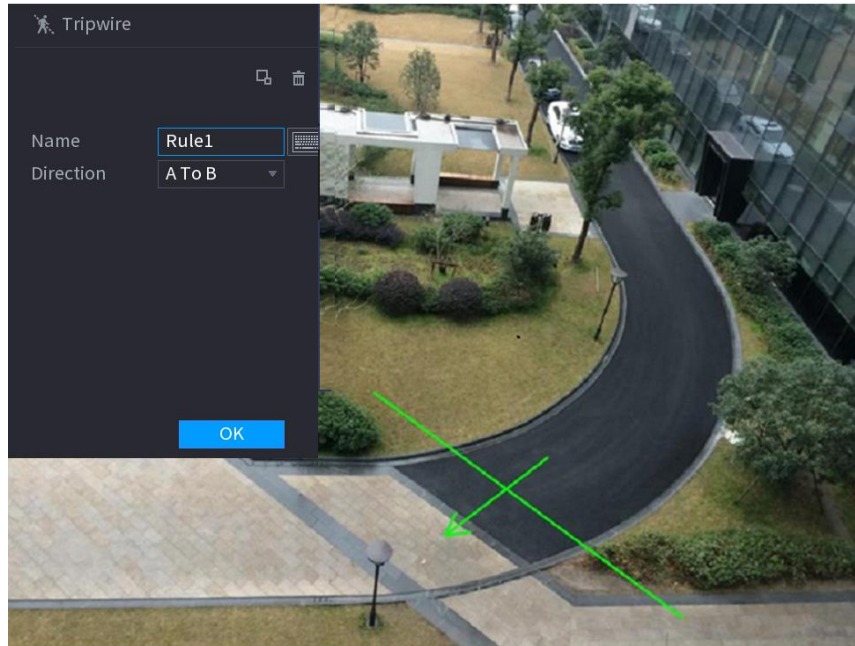

2) Configure the parameters. See Table 4-29.

Table 4-29

Parameter	Description
Name	Customize the rule name.
Direction	Set the tripwire direction, including A→B, B→A and A↔B.
Filter target	<p>Click  to filter the target. Check the blue wireframe and adjust the size of the area with the mouse.</p> <p></p> <p>Each rule can set 2 target filters (maximum size and minimum size), that is, when the passing target is smaller than the minimum target or larger than the maximum target, no alarm will be generated. The maximum size should not be smaller than the minimum size.</p>
AI Recognition	<p>Select AI recognition and the system displays alarm target. The default selection is person and motor vehicle and system automatically identifies the person and motor vehicle appeared within the monitoring range.</p> <p></p> <p>When you select IVS of AI by camera, the connected channel shall support tripwire function.</p>

- 3) Press and hold down the left button on the monitor screen to draw the line. The line can be a straight line or a curve.
- 4) Click **OK** to complete the rule setting.



**Step 3** Click .



System displays the **Trigger** interface. See Figure 4-133.

Figure 4-133

Step 4 Configure the parameters. See Table 4-30.

Table 4-30

Parameter	Description
Period	Configure the period and in the set time range, the corresponding configuration item will be linked to start the alarm.
Alarm Out	The alarm device (such as lights, sirens, etc.) is connected to the alarm output port. When an alarm occurs, the NVR device transmits the alarm information to the alarm device.
Latch	When the alarm ends, the alarm extended for a period of time. The time range is from 0 seconds to 300 seconds.
Alarm Upload	Select the check box. When an alarm occurs, the NVR device uploads an alarm signal to the network (including the alarm center).  <ul style="list-style-type: none"> <li>This function is for some series products only.</li> <li>You need to set the alarm center first. For details, see "4.12.11 Alarm Cente."</li> </ul>
Send Email	Select the check box. When an alarm occurs, the NVR device sends an email to the set mailbox to notify the user.  <p>You need to set the email first. For details, see "4.12.8 Email."</p>
Record Channel	Select the check box and select the needed recording channel (support multiple choices). When an alarm occurs, the NVR device activates the channel for recording.  <p>You need to enable intelligent recording and auto recording first. For details, see "4.1.4.6 Schedule."</p>

Parameter	Description
PTZ Activation	<p>Select the check box and click <b>Setting</b> to select the channel and PTZ action. When an alarm occurs, the NVR device associates the channel to perform the corresponding PTZ action. For example, activate the PTZ in channel one to turn to the preset point X.</p>  <ul style="list-style-type: none"> <li>• Tripwire alarm supports to activate PTZ preset point only.</li> <li>• You need to set the corresponding PTZ actions first, see "4.4.3 Configuring PTZ Functions."</li> </ul>
Delay	At the end of the alarm, the recording extends for a period of time. The time range is from 10 seconds to 300 seconds.
Tour	<p>Select the check box and select the channel for tour. When an alarm occurs, the local interface of the NVR device displays the selected channel screen.</p>  <ul style="list-style-type: none"> <li>• You need to set the time interval and mode for tour first, see "4.17.2 Tour. "</li> <li>• After the tour is over, the preview interface is restored to the screen split mode before the tour.</li> </ul>
Log	Select the check box, the NVR device records the alarm information in the log when an alarm occurs.
Voice Prompts	<p>Check the box and then select the corresponding audio file from the dropdown list. System plays the audio file when the alarm occurs.</p>  <p>Refer to "4.18.1 File Manage " to add audio file first.</p>
Buzzer	Select the check box to activate the buzzer when an alarm occurs.

**Step 5** Click **OK** to save the alarm setting.  
System displays the IVS interface.

**Step 6** Select the **Enable** check box and click **Apply** to complete the tripwire setting.

#### 4.7.2.4.2 Intrusion

When the detection target passes the edge of the monitoring area, and enters, leaves or traverses the monitoring area, the system performs an alarm linkage action.

**Step 1** In the **Type** drop-down list, select **Intrusion**. See Figure 4-134.

Figure 4-134

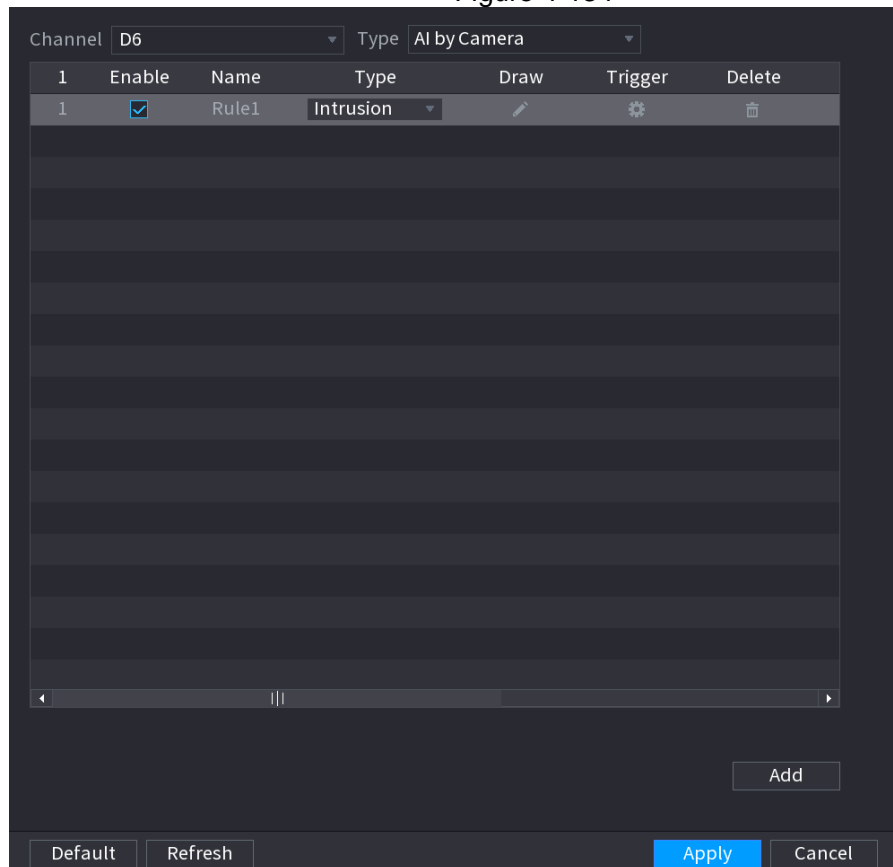

**Step 2** Draw the detection rule.



- 1) Click  to draw the rule on the surveillance video, the system displays as Figure 4-135.

Figure 4-135

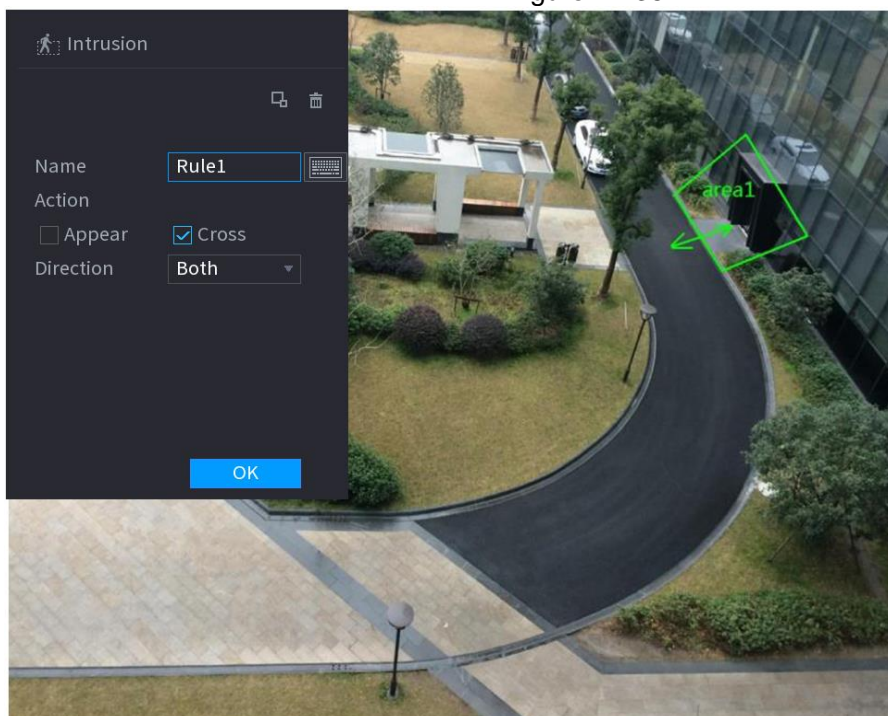

- 2) Configure the parameters. See Table 4-31.

Table 4-31

Parameter	Description
Name	Customize the rule name.
Action	Set the intrusion action, including appear and crossing area.
Direction	Set the direction to cross the area, including enter, exit and both.
Filter target	<p>Click  to filter the target. Check the blue wireframe and adjust the size of the area with the mouse.</p> <p></p> <p>Each rule can set 2 target filters (maximum size and minimum size), that is, when the passing target is smaller than the minimum target or larger than the maximum target, no alarm will be generated. The maximum size should not be smaller than the minimum size.</p>
AI recognition	Select AI recognition and the system displays alarm target. The default selection is person and motor vehicle and system automatically identifies the person and motor vehicle appeared within the monitoring range.

- 3) Press and hold down the left button on the monitoring screen to draw the monitoring area.
- 4) Click **OK** to complete the rule setting.

**Step 3** Click , you can refer to the "4.7.2.4.1 Tripwire" to set other parameters.

**Step 4** Select the **Enable** check box and click **Apply** to complete the intrusion setting.

#### 4.7.2.4.3 Abandoned Object Detection

System generates an alarm when there is abandoned object in the specified zone.

**Step 1** In the **Type** drop-down list, select **Abandoned Object**.

The interface is shown as Figure 4-136.

Figure 4-136

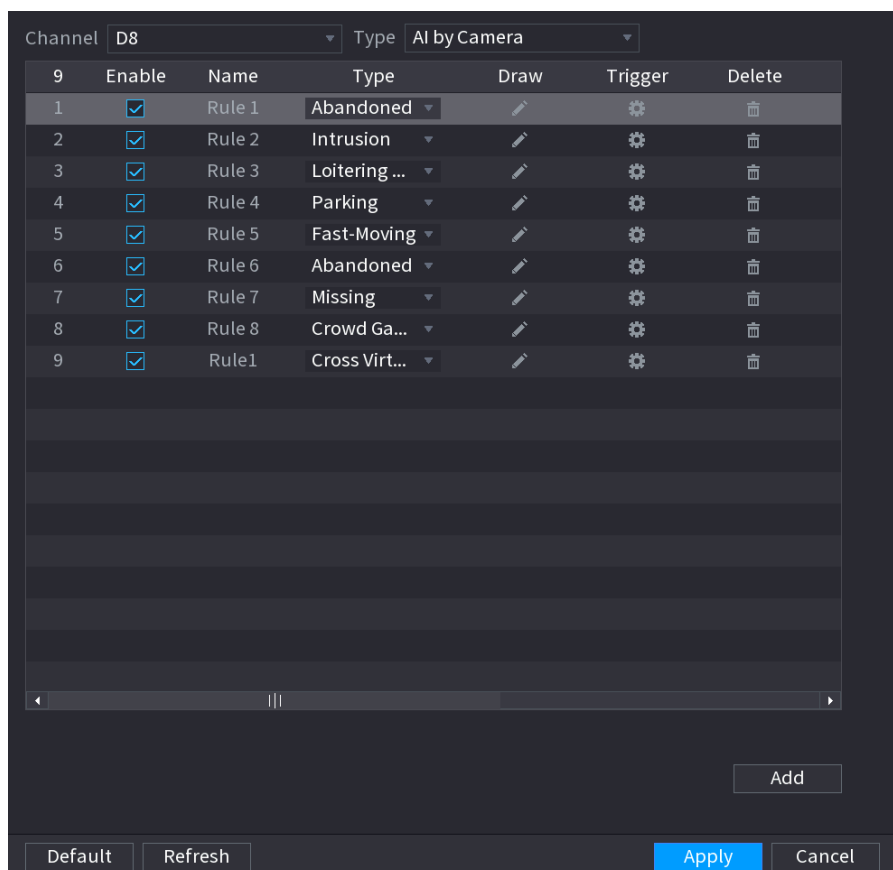

**Step 2** Draw the detection rule.

- 1) Click  to draw the rule on the surveillance video. See Figure 4-137.





Figure 4-137

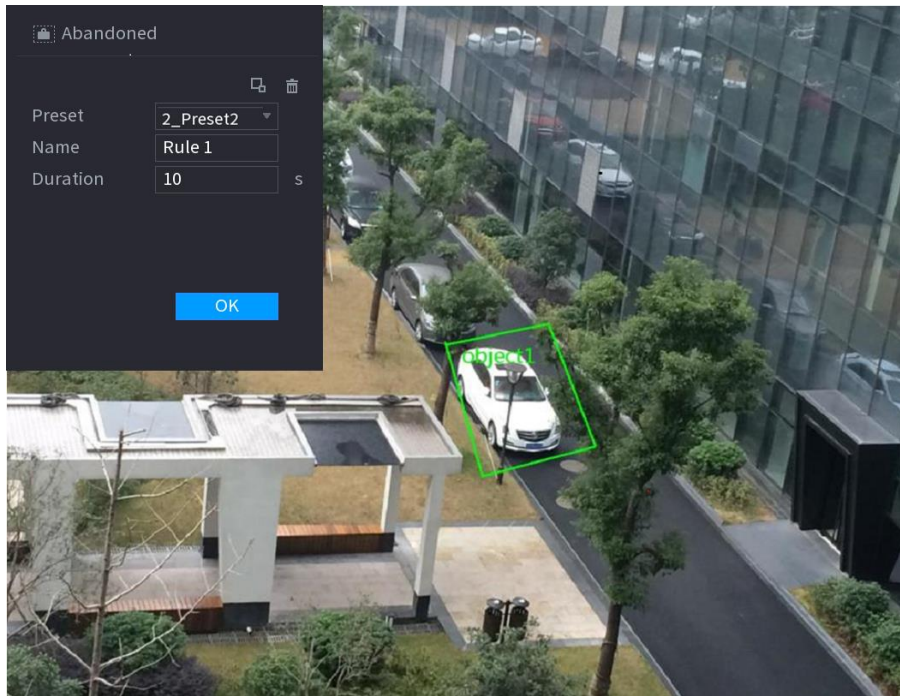

2) Set parameters. See Table 4-32.

Table 4-32

Parameter	Description
Preset	Select a preset you want to use IVS
Name	Input customized rule name
Duration	System can generate an alarm once the object is in the zone for the specified period.
Filter target	<p>Click  to filter the target. Check the blue wireframe and adjust the size of the area with the mouse.</p> <p></p> <p>Each rule can set 2 target filters (maximum size and minimum size), that is, when the passing target is smaller than the minimum target or larger than the maximum target, no alarm will be generated. The maximum size should not be smaller than the minimum size.</p>

- 3) Draw a rule. Left click mouse to draw a zone, until you draw a rectangle, you can right click mouse.
- 4) Click **OK** to complete the rule setting.

Step 3 Click , you can refer to the "4.7.2.4.1 Tripwire" to set other parameters.

Step 4 Click **Apply** to complete the setup.

#### 4.7.2.4.4 Fast moving

You can detect the fast moving object in the specified zone.

Step 1 In the **Type** drop-down list, select **Fast Moving**.  
The interface is shown as below. See Figure 4-138.

Figure 4-138

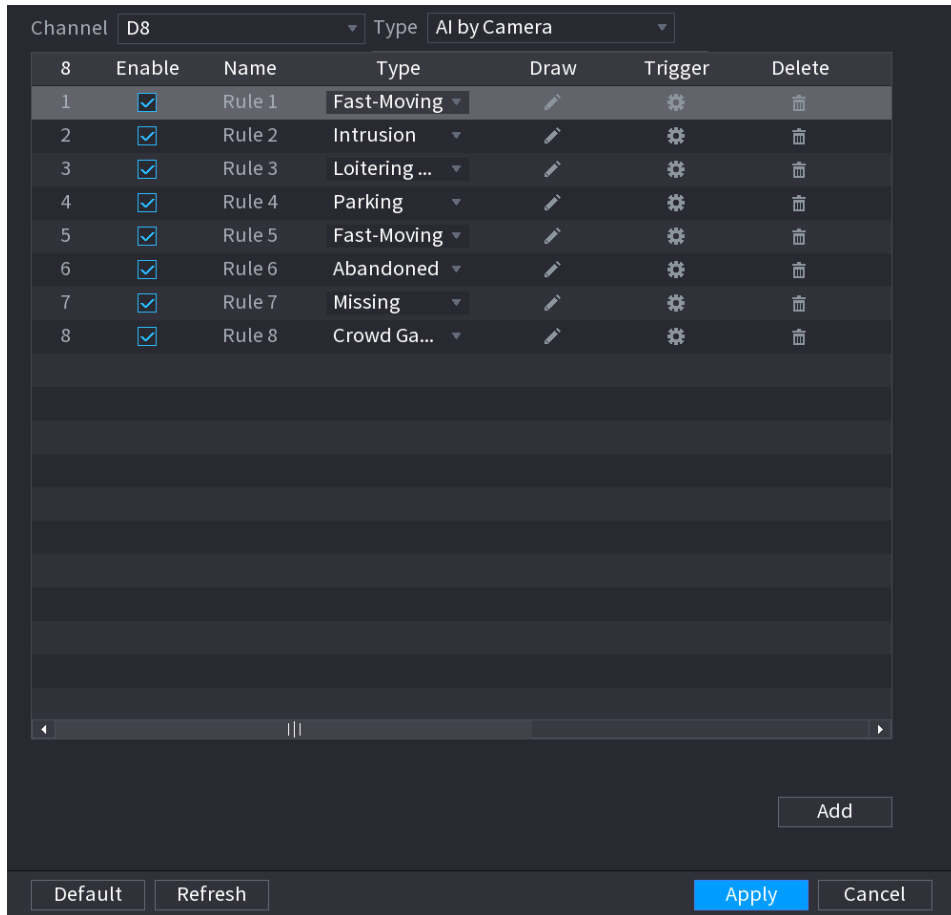

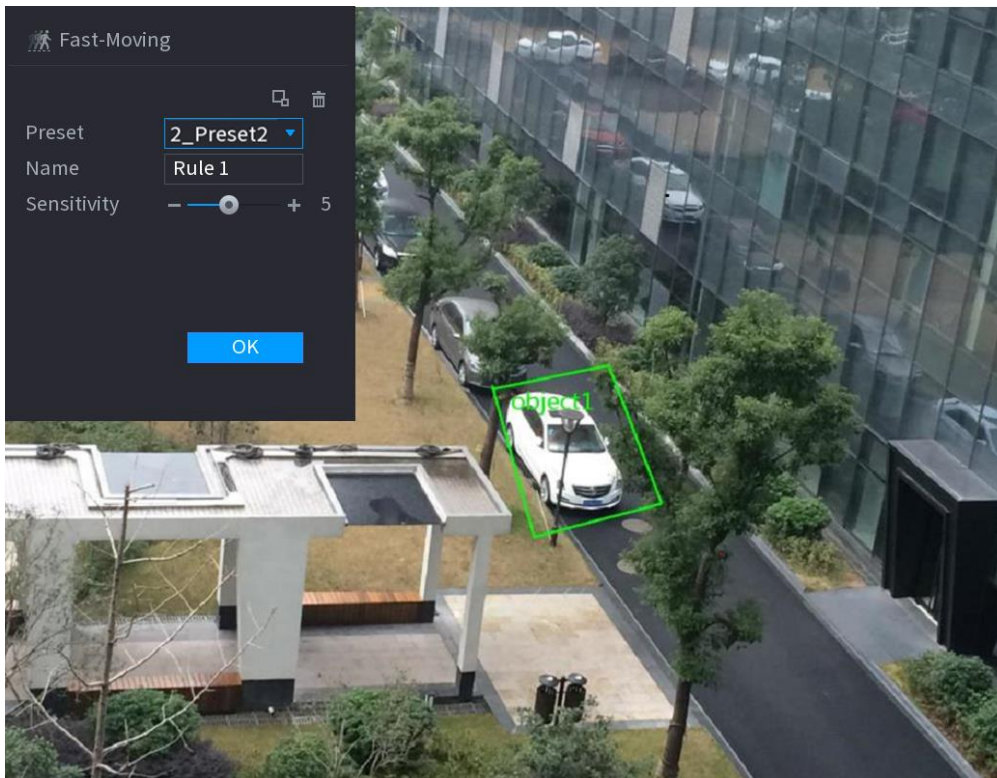

**Step 2** Draw the detection rule.

- 1) Click  to draw the rule on the surveillance video. See Figure 4-139.  
Figure 4-139



- 2) Set parameters. See Table 4-33.

Table 4-33

Parameter	Description
Preset	Select a preset you want to use IVS
Name	Input customized rule name
Sensitivity	You can set alarm sensitivity. The value ranges from 1 to 10. The default setup is 5.
Filter target	<p>Click  to filter the target. Check the blue wireframe and adjust the size of the area with the mouse.</p> <p></p> <p>Each rule can set 2 target filters (maximum size and minimum size), that is, when the passing target is smaller than the minimum target or larger than the maximum target, no alarm will be generated. The maximum size should not be smaller than the minimum size.</p>

- 3) Draw a rule. Left click mouse to draw a zone, until you draw a rectangle, you can right click mouse.
- 4) Click **OK** to complete the rule setting.

Step 3 Click , you can refer to the "4.7.2.4.1 Tripwire" to set other parameters.

Step 4 Click **Apply** to complete the setup.

#### 4.7.2.4.5 Crowd Gathering

System can generate an alarm once the people amount gathering in the specified zone is larger than the threshold.

Step 1 In the **Type** drop-down list, select **Crowd Gathering Estimation**. The interface is shown as below. See Figure 4-140.

Figure 4-140

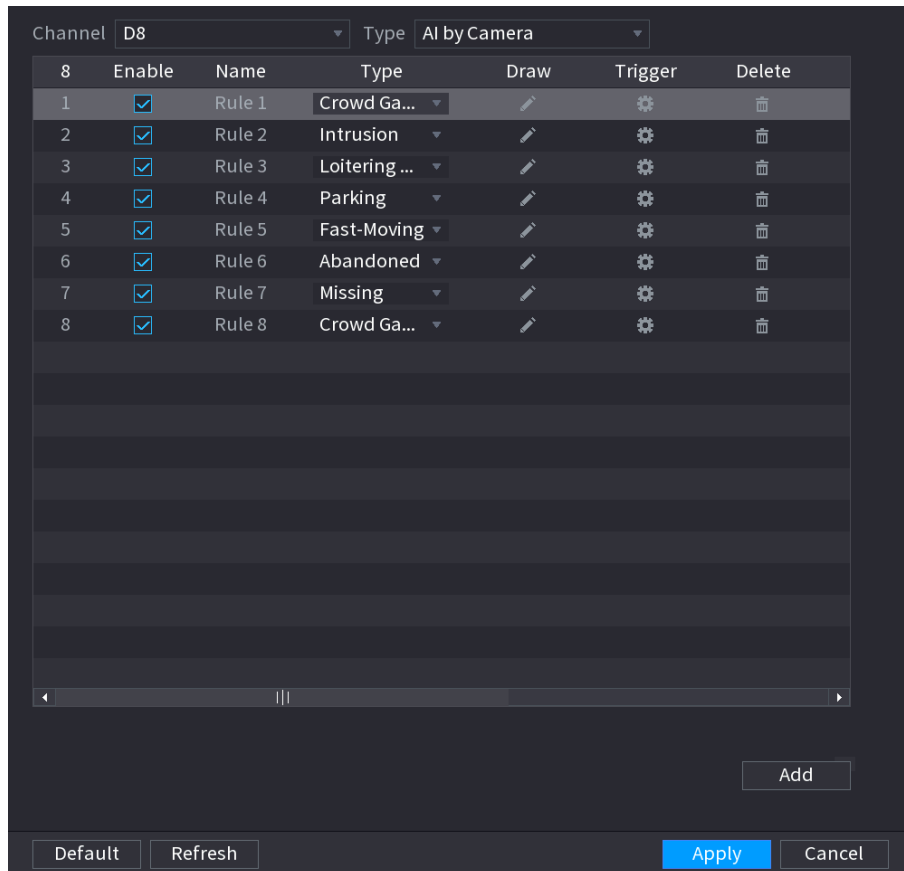

Step 2 Draw the detection rule.



- 1) Click  to draw the rule on the surveillance video. See Figure 4-141.

Figure 4-141

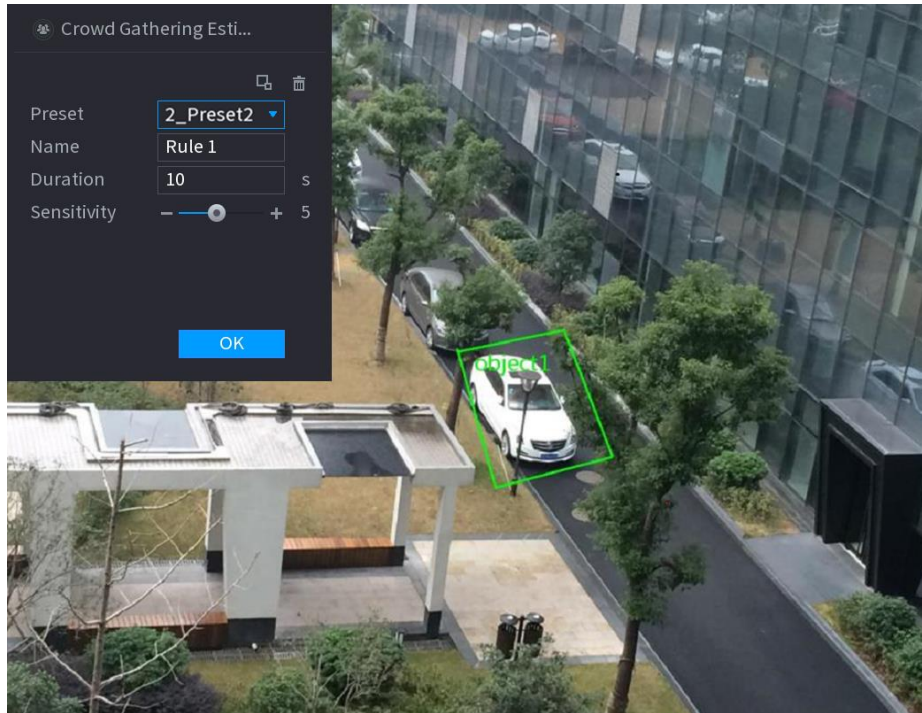

2) Set parameters. See Table 4-34.

Table 4-34

Parameter	Description
Preset	Select a preset you want to use IVS.
Name	Input customized rule name
Duration	Set the minimum time that the object stays until the alarm is triggered.
Filter target	<p>Click  to filter the target. Check the blue wireframe and adjust the size of the area with the mouse.</p> <p></p> <p>Each rule can set 2 target filters (maximum size and minimum size), that is, when the passing target is smaller than the minimum target or larger than the maximum target, no alarm will be generated. The maximum size should not be smaller than the minimum size.</p>

3) Draw a rule. Left click mouse to draw a zone, until you draw a rectangle, you can right click mouse.

4) Click **OK** to complete the rule setting.

Step 3 Click , you can refer to the "4.7.2.4.1 Tripwire" to set other parameters.

Step 4 Click **Apply** to complete the setup.

#### 4.7.2.4.6 Parking

When the detection target stays in the monitoring area for more than the set duration, the system performs alarm linkage action.

Step 1 In the **Type** drop-down list, select **Parking**.  
The interface is shown as below. See Figure 4-142.

Figure 4-142

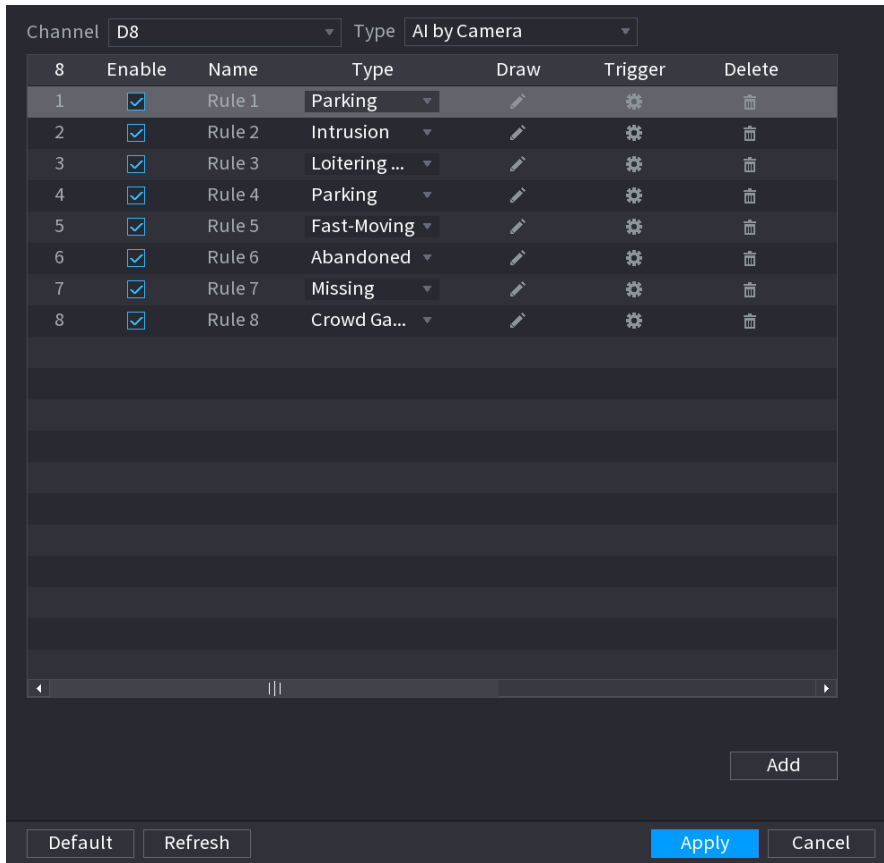

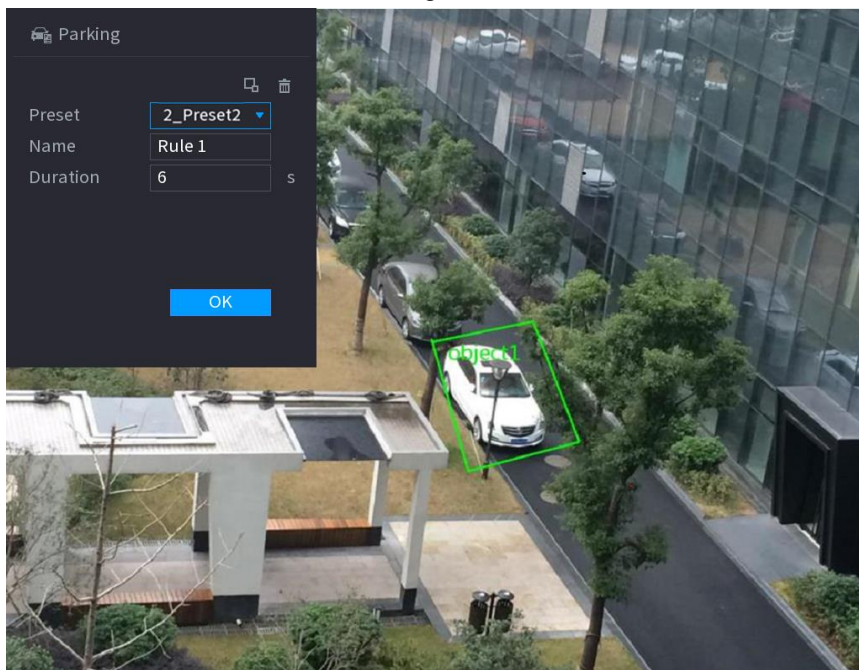

**Step 2** Draw the detection rule.

- 1) Click to draw the rule on the surveillance video. See Figure 4-143.  
Figure 4-143



- 2) Set parameters. See Table 4-35.

Table 4-35

Parameter	Description
Preset	Set the preset point for IVS detection according to the actual needs.
Name	Customize the rule name.
Duration	Set the minimum time that the object stays until the alarm is triggered.
Filter target	<p>Click  to filter the target. Check the blue wireframe and adjust the size of the area with the mouse.</p> <p></p> <p>Each rule can set 2 target filters (maximum size and minimum size), that is, when the passing target is smaller than the minimum target or larger than the maximum target, no alarm will be generated. The maximum size should not be smaller than the minimum size.</p>

- 3) Draw a rule. Left click mouse to draw a zone, until you draw a rectangle, you can right click mouse.
- 4) Click **OK** to complete the rule setting.

**Step 3** Click , you can refer to the "4.7.2.4.1 Tripwire" to set other parameters.

**Step 4** Click **Apply** to complete the setup.

#### 4.7.2.4.7 Missing Object Detection

System generates an alarm when there is missing object in the specified zone.

**Step 1** In the **Type** drop-down list, select **Missing Object**.  
The interface is shown as below. See Figure 4-144.

Figure 4-144

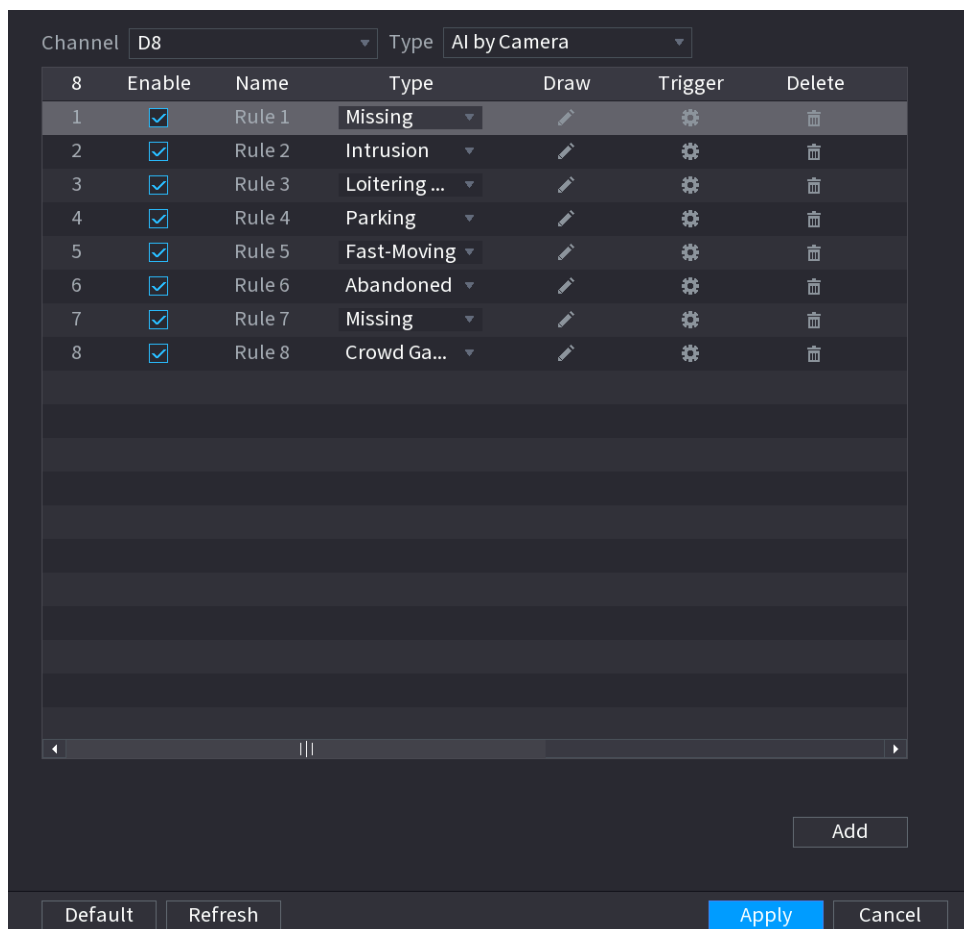

**Step 2** Draw the detection rule.



- 1) Click  to draw the rule on the surveillance video. See Figure 4-145.

Figure 4-145

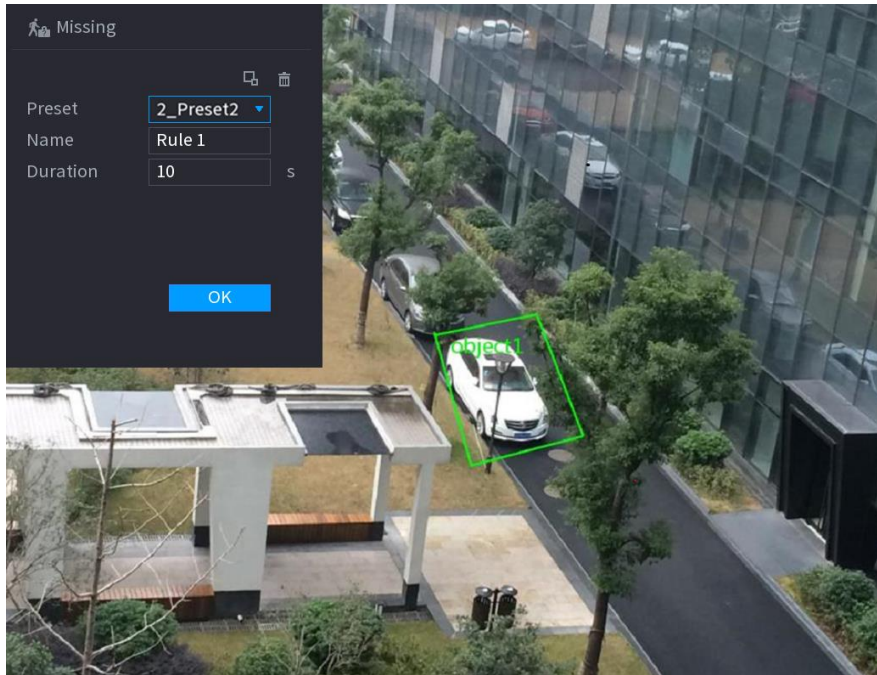

2) Set parameters. See Table 4-36.

Table 4-36

Parameter	Description
Preset	Set the preset point for IVS detection according to the actual needs.
Name	Customize the rule name.
Duration	Set the minimum time that the object stays until the alarm is triggered.
Filter target	<p>Click  to filter the target. Check the blue wireframe and adjust the size of the area with the mouse.</p> <p></p> <p>Each rule can set 2 target filters (maximum size and minimum size), that is, when the passing target is smaller than the minimum target or larger than the maximum target, no alarm will be generated. The maximum size should not be smaller than the minimum size.</p>

3) Draw a rule. Left click mouse to draw a zone, until you draw a rectangle, you can right click mouse.

4) Click **OK** to complete the rule setting.

**Step 3** Click , you can refer to the "4.7.2.4.1 Tripwire" to set other parameters.

**Step 4** Click **Apply** to complete the setup.

#### 4.7.2.4.8 Loitering Detection

System can generate an alarm once the object is staying in the specified zone longer than the threshold.

**Step 1** In the **Type** drop-down list, select **Loitering Detection**.  
The interface is shown as below. See Figure 4-146.

Figure 4-146

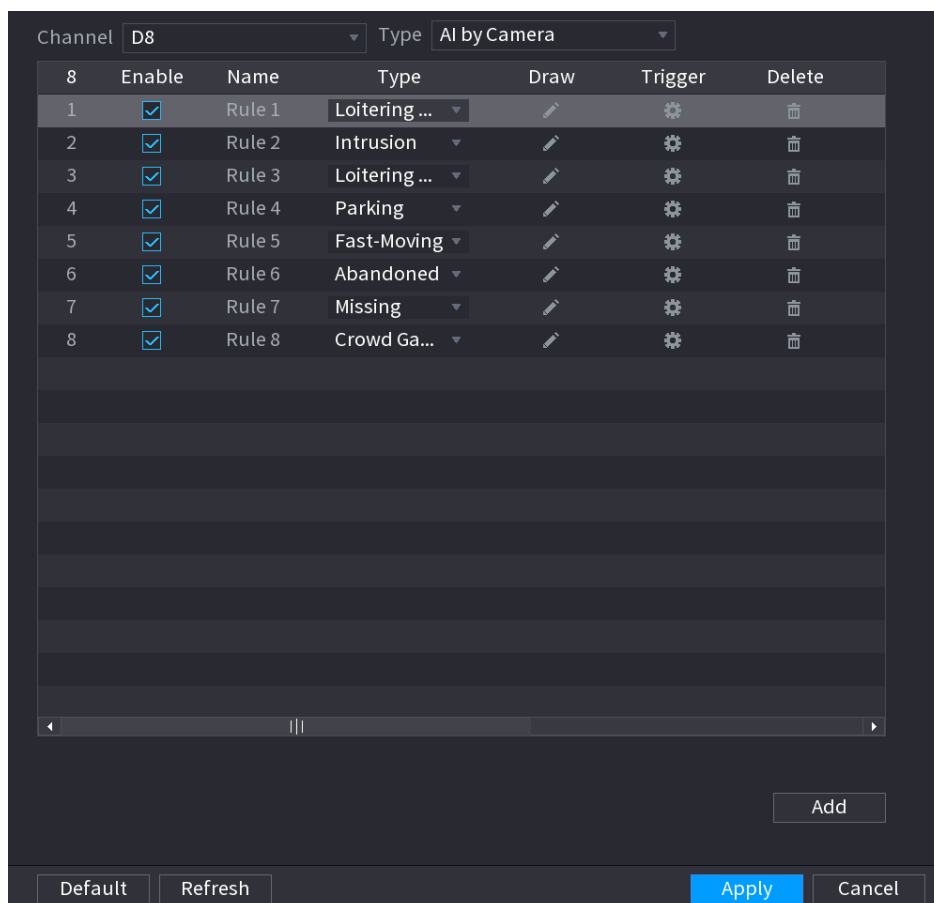

**Step 2** Draw the detection rule.

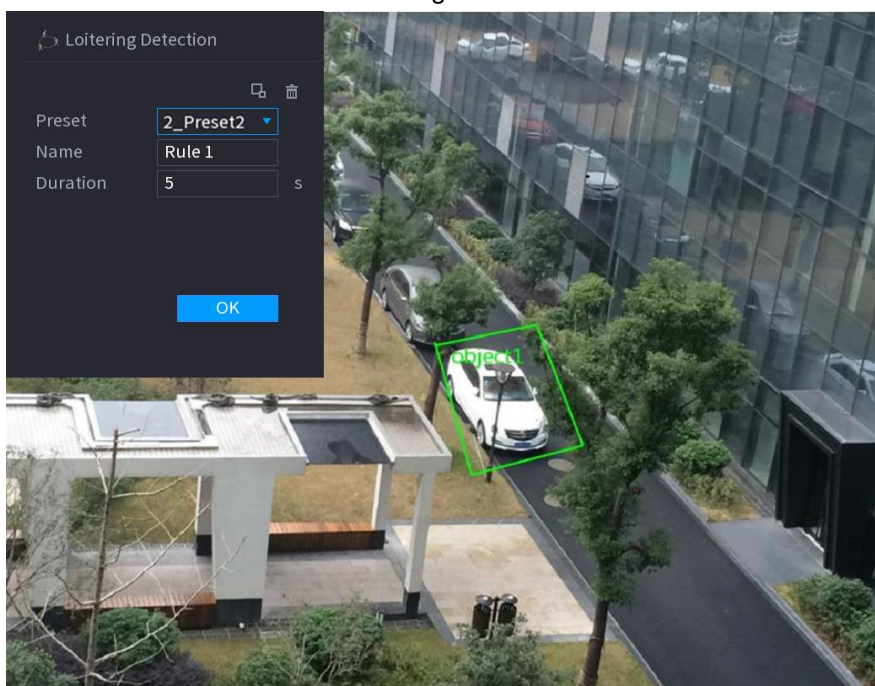

- 1) Click  to draw the rule on the surveillance video. See Figure 4-147.  
Figure 4-147



- 2) Set parameters. See Table 4-37.



Table 4-37

Parameter	Description
Preset	Set the preset point for IVS detection according to the actual needs.
Name	Customize the rule name.
Duration	Set the minimum time that the object stays until the alarm is triggered.
Filter target	<p>Click  to filter the target. Check the blue wireframe and adjust the size of the area with the mouse.</p> <p></p> <p>Each rule can set 2 target filters (maximum size and minimum size), that is, when the passing target is smaller than the minimum target or larger than the maximum target, no alarm will be generated. The maximum size should not be smaller than the minimum size.</p>

- 3) Draw a rule. Left click mouse to draw a zone, until you draw a rectangle, you can right click mouse.
- 4) Click **OK** to complete the rule setting.

Step 3 Click , you can refer to the "4.7.2.4.1 Tripwire" to set other parameters.

Step 4 Click **Apply** to complete the setup.

#### 4.7.2.5 Video Structuring (Metadata)

The device can detect and extract key features from the human body, motor vehicle, and non-motor vehicles in the video, and then build a structured database. You can search any target you need with these features.

After enable the video structuring function, the corresponding smart plan can become valid.

### Preparations

Make sure the connected camera supports video structuring (metadata) function.

Step 1 Select **Main Menu > AI > PARAMETERS > VIDEO STRUCTURING**.  
The **VIDEO STRUCTURING** interface is displayed. See Figure 4-148.

Figure 4-148

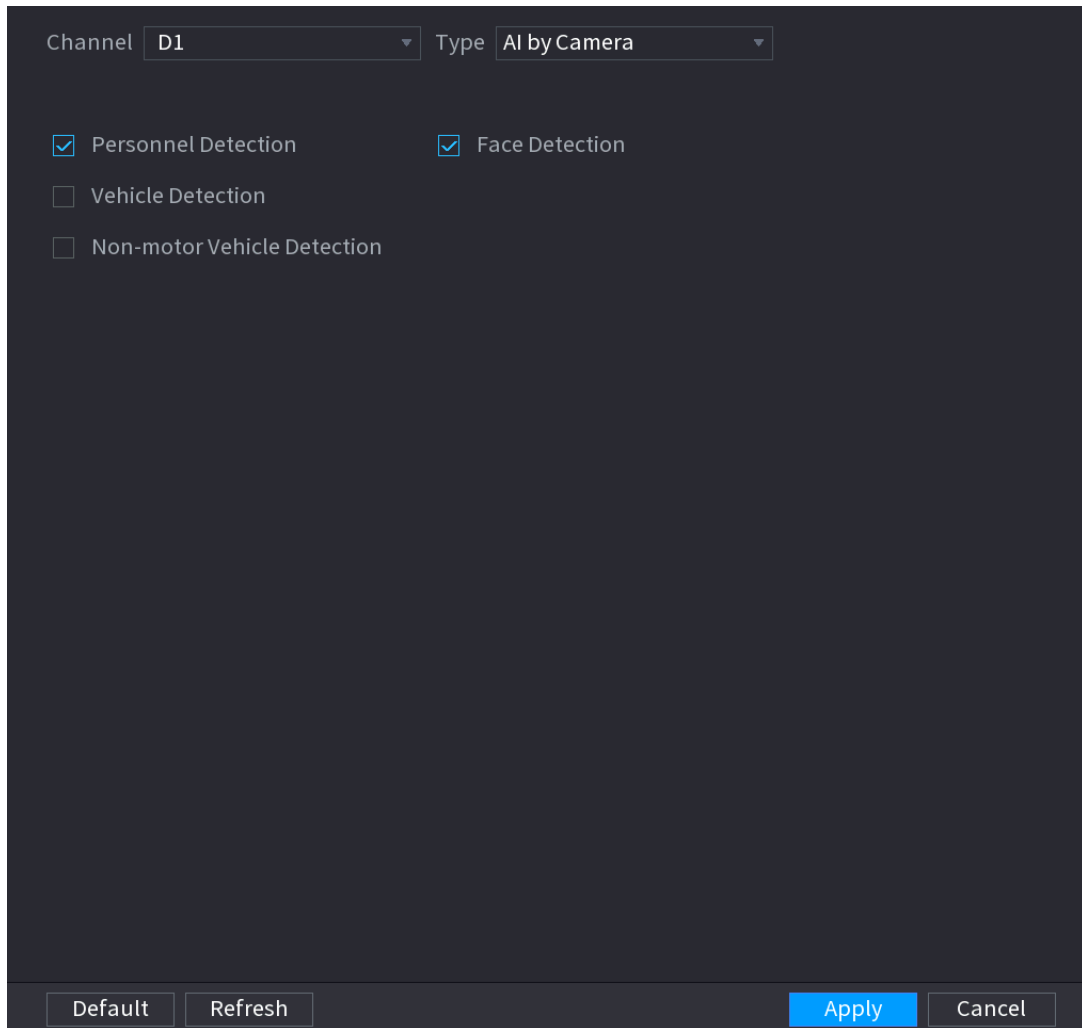

**Step 2** In the **Channel** list, select a channel that you want to configure video structuring function, and then enable it. See Table 4-38.

Table 4-38

Parameter	Description
Human Detection	Select <b>Human detection</b> and then check the box to enable this function.
Face Detect	Select <b>Face Detect</b> and then check the box to enable this function.
Vehicle detection	Select <b>Vehicle detection</b> and then check the box to enable this function.
Non-motor Vehicle	Select <b>Non-motor Vehicle</b> and then check the box to enable this function.

**Step 3** Click **Apply**.

#### 4.7.2.6 Crowd Distribution

Connecting to the front-end device that supports crowd distribution function, system can support the crowd distribution function. It supports crowd distribution event subscription and receive. It supports crowd distribution global and regional density settings, linkage alarm and triggered video storage, or upload the data to the platform. After connecting to the general network camera, the system adopts the algorithm to analyze the crowd density and trigger the corresponding actions.

**Step 1** Select **Main Menu > AI > PARAMETERS > CROWD DISTRIBUTION**. The **CROWD DISTRIBUTION** interface is displayed. See Figure 4-149.

Figure 4-149

The screenshot shows a configuration page for a crowd density alarm. At the top right, there are icons for 'LIVE', a user profile, and a refresh icon. The main configuration area includes:





- Channel:** A dropdown menu set to 'D6'.
- Enable:** A checked checkbox.
- Global:** A checked checkbox.
- Crowd Density:** A text input field containing '4' with the unit 'Human/m<sup>2</sup>'.
- Period:** A 'Setting' button.
- Alarm Out:** A 'Setting' button.
- Latch:** A text input field containing '0' with the unit 'Sec'.
- Alarm Upload:** An unchecked checkbox.
- Send Email:** An unchecked checkbox.
- Record Channel:** An unchecked checkbox with a 'Setting' button.
- PTZ Activation:** An unchecked checkbox with a 'Setting' button.
- Post-Record:** A text input field containing '10' with the unit 'Sec'.
- Tour:** An unchecked checkbox with a 'Setting' button.
- Buzzer:** An unchecked checkbox.
- Log:** An unchecked checkbox.
- Voice Prompts:** A dropdown menu set to 'None'.
- Alarm Tracking:** An unchecked checkbox.

At the bottom of the page, there are four buttons: 'Default', 'Refresh', 'Apply' (highlighted in blue), and 'Back'.

Step 2 Configure parameters. See Table 4-39.

Table 4-39

Parameter	Description
Channel	Select a channel from the dropdown list.
Enable	Check the box to enable the function.
Global	Check the box to enable global crowd distribution alarm.
Crowd Density	Configure the alarm threshold. The default setup is 4 persons/m <sup>2</sup> . The value ranges from 2 to 10.
Period	Configure the period and in the set time range, the corresponding configuration item will be linked to start the alarm.
Alarm Out	The alarm device (such as lights, sirens, etc.) is connected to the alarm output port. When an alarm occurs, the NVR device transmits the alarm information to the alarm device.
Latch	When the alarm ends, the alarm extended for a period of time. The time range is from 0 seconds to 300 seconds.
Alarm Upload	<p>Select the check box. When an alarm occurs, the NVR device uploads an alarm signal to the network (including the alarm center).</p> <p></p> <ul style="list-style-type: none"> <li>This function is for some series products only.</li> <li>You need to set the alarm center first. For details, see "4.12.11 Alarm Cente."</li> </ul>

Parameter	Description
Send Email	Select the check box. When an alarm occurs, the NVR device sends an email to the set mailbox to notify the user.  You need to set the email first. For details, see "4.12.8 Email."
Record Channel	Select the check box and select the needed recording channel (support multiple choices). When an alarm occurs, the NVR device activates the channel for recording.  You need to enable intelligent recording and auto recording first. For details, see "4.1.4.6 Schedule."
PTZ Activation	Select the check box and click <b>Setting</b> to select the channel and PTZ action. When an alarm occurs, the NVR device associates the channel to perform the corresponding PTZ action. For example, activate the PTZ in channel one to turn to the preset point X.  <ul style="list-style-type: none"> <li>• Tripwire alarm supports to activate PTZ preset point only.</li> <li>• You need to set the corresponding PTZ actions first, see "4.4.3 Configuring PTZ Functions."</li> </ul>
Delay	At the end of the alarm, the recording extends for a period of time. The time range is from 10 seconds to 300 seconds.
Tour	Select the check box and select the channel for tour. When an alarm occurs, the local interface of the NVR device displays the selected channel screen.  <ul style="list-style-type: none"> <li>• You need to set the time interval and mode for tour first, see "4.17.2 Tour. "</li> <li>• After the tour is over, the preview interface is restored to the screen split mode before the tour.</li> </ul>
Log	Select the check box, the NVR device records the alarm information in the log when an alarm occurs.
Voice Prompts	Check the box and then select the corresponding audio file from the dropdown list. System plays the audio file when the alarm occurs.  Refer to "4.18.1 File Manage " to add audio file first.
Buzzer	Select the check box to activate the buzzer when an alarm occurs.

**Step 3** Click **Apply** to complete the setup.

#### 4.7.2.7 People Counting

System adopts video image and graphics analysis technology. System can calculate the entry/exit people amount in the specified zone on the video. It can generate an alarm when the amount has exceeded the threshold.

##### 4.7.2.7.1 People Counting

**Step 1** Select **Main Menu > AI > PARAMETERS > PEOPLE COUNTING > PEOPLE COUNTING**.







The **PEOPLE COUNTING** interface is displayed. See Figure 4-150.

Figure 4-150

Step 2 Configure parameters. See Table 4-40.

Table 4-40

Parameter	Description
Channel	Select a channel from the dropdown list.
Enable	Check the box to enable the function.
Rule Type	Select a people counting rule type.
Rule	Click <b>RULE</b> to set statistics region, name, direction.
Alarm	Click <b>Setting</b> to set alarm parameters. <ul style="list-style-type: none"> <li>● <b>OSD Overlay:</b> Check the box here; you can view the people amount on the surveillance video.</li> <li>● <b>Entry No.:</b> You can set people entry amount. System can generate an alarm once the amount has exceeded the threshold.</li> <li>● <b>Exit No.:</b> You can set people exit amount. System can generate an alarm once the amount has exceeded the threshold.</li> <li>● <b>Remaining No.:</b> You can set people staying amount in the zone. System can generate an alarm once the amount has exceeded the threshold.</li> </ul>
Period	Configure the period and in the set time range, the corresponding configuration item will be linked to start the alarm.
Alarm Out	The alarm device (such as lights, sirens, etc.) is connected to the alarm output port. When an alarm occurs, the NVR device transmits the alarm information to the alarm device.

Parameter	Description
Latch	When the alarm ends, the alarm extended for a period of time. The time range is from 0 seconds to 300 seconds.
Alarm Upload	Select the check box. When an alarm occurs, the NVR device uploads an alarm signal to the network (including the alarm center).  <ul style="list-style-type: none"> <li>This function is for some series products only.</li> <li>You need to set the alarm center first. For details, see "4.12.11 Alarm Cente."</li> </ul>
Send Email	Select the check box. When an alarm occurs, the NVR device sends an email to the set mailbox to notify the user.  You need to set the email first. For details, see "4.12.8 Email."
Record Channel	Select the check box and select the needed recording channel (support multiple choices). When an alarm occurs, the NVR device activates the channel for recording.  You need to enable intelligent recording and auto recording first. For details, see "4.1.4.6 Schedule."
PTZ Activation	Select the check box and click <b>Setting</b> to select the channel and PTZ action. When an alarm occurs, the NVR device associates the channel to perform the corresponding PTZ action. For example, activate the PTZ in channel one to turn to the preset point X.  <ul style="list-style-type: none"> <li>Tripwire alarm supports to activate PTZ preset point only.</li> <li>You need to set the corresponding PTZ actions first, see "4.4.3 Configuring PTZ Functions."</li> </ul>
Delay	At the end of the alarm, the recording extends for a period of time. The time range is from 10 seconds to 300 seconds.
Tour	Select the check box and select the channel for tour. When an alarm occurs, the local interface of the NVR device displays the selected channel screen.  <ul style="list-style-type: none"> <li>You need to set the time interval and mode for tour first, see "4.17.2 Tour. "</li> <li>After the tour is over, the preview interface is restored to the screen split mode before the tour.</li> </ul>
Log	Select the check box, the NVR device records the alarm information in the log when an alarm occurs.
Voice Prompts	Check the box and then select the corresponding audio file from the dropdown list. System plays the audio file when the alarm occurs.  Refer to "4.18.1 File Manage " to add audio file first.
Buzzer	Select the check box to activate the buzzer when an alarm occurs.

**Step 3** Click **Apply** to complete the setup.

#### 4.7.2.7.2 Queuing

After connecting to the AI fisheye camera that supports the queuing function, system can realize the corresponding linkage actions once the people amount in the queue or the waiting time has trigger an alarm. Select a region first to set the corresponding actions. For the same line, the queue people number alarm and queue time alarm has the same linkage actions.

**Step 1** Select **Main Menu > AI > PARAMETERS > PEOPLE COUNTING > Queuing**.  
The **Queuing** interface is displayed. See Figure 4-151.

Figure 4-151

PEOPLE COUN... **Queuing**

Channel: D8

Region: [Dropdown]

Alarm Type:  Queue People No. A...  Queue Time Alarm

Period: [Setting]

Alarm Out: [Setting] Latch: 0 Sec.  Send Email

Record Channel: [Setting]

PTZ Activation: [Setting] Post-Record: 10 Sec.

Tour: [Setting]



Buzzer  Log





Voice Prompts: None

[Refresh] [Apply] [Back]

**Step 2** Configure parameters. See Table 4-41.

Table 4-41

Parameter	Description
Channel	Select a channel from the dropdown list.
Region	Set queue detection region.
Alarm Type	Select <b>Queue People No. Alarm</b> or <b>Queue Time Alarm</b> .
Period	Configure the period and in the set time range, the corresponding configuration item will be linked to start the alarm.
Alarm Out	The alarm device (such as lights, sirens, etc.) is connected to the alarm output port. When an alarm occurs, the NVR device transmits the alarm information to the alarm device.
Latch	When the alarm ends, the alarm extended for a period of time. The time range is from 0 seconds to 300 seconds.
Alarm Upload	Select the check box. When an alarm occurs, the NVR device uploads an alarm signal to the network (including the alarm center).  <ul style="list-style-type: none"> <li>This function is for some series products only.</li> <li>You need to set the alarm center first. For details, see "4.12.11 Alarm Cente."</li> </ul>
Send Email	Select the check box. When an alarm occurs, the NVR device sends an email to the set mailbox to notify the user.  <p>You need to set the email first. For details, see "4.12.8 Email."</p>

Parameter	Description
Record Channel	Select the check box and select the needed recording channel (support multiple choices). When an alarm occurs, the NVR device activates the channel for recording.  You need to enable intelligent recording and auto recording first. For details, see "4.1.4.6 Schedule."
PTZ Activation	Select the check box and click <b>Setting</b> to select the channel and PTZ action. When an alarm occurs, the NVR device associates the channel to perform the corresponding PTZ action. For example, activate the PTZ in channel one to turn to the preset point X.  <ul style="list-style-type: none"> <li>• Tripwire alarm supports to activate PTZ preset point only.</li> <li>• You need to set the corresponding PTZ actions first, see "4.4.3 Configuring PTZ Functions."</li> </ul>
Delay	At the end of the alarm, the recording extends for a period of time. The time range is from 10 seconds to 300 seconds.
Tour	Select the check box and select the channel for tour. When an alarm occurs, the local interface of the NVR device displays the selected channel screen.  <ul style="list-style-type: none"> <li>• You need to set the time interval and mode for tour first, see "4.17.2 Tour. "</li> <li>• After the tour is over, the preview interface is restored to the screen split mode before the tour.</li> </ul>
Log	Select the check box, the NVR device records the alarm information in the log when an alarm occurs.
Voice Prompts	Check the box and then select the corresponding audio file from the dropdown list. System plays the audio file when the alarm occurs.  Refer to "4.18.1 File Manage " to add audio file first.
Buzzer	Select the check box to activate the buzzer when an alarm occurs.

**Step 3** Click **Apply** to complete the setup.

#### 4.7.2.8 Heat map

Heat map technology can monitor the active objects distribution status on the specified zone during a period of time, and use the different colors to display on the heat map.

**Step 1** Select **Main Menu > AI > PARAMETERS > HEAT MAP**.  
The **HEAT MAP** interface is displayed. See Figure 4-152.



Figure 4-152

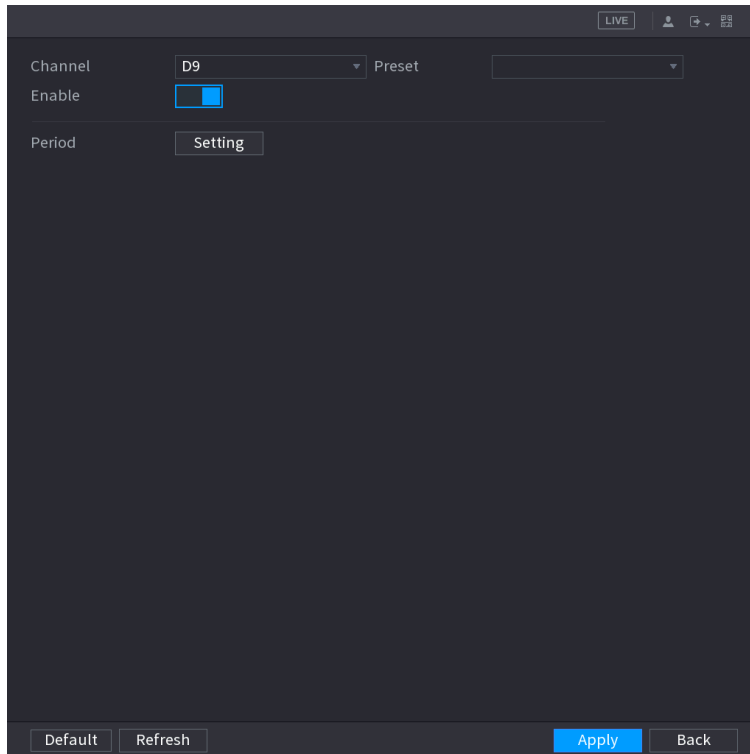

Step 2 Select a channel number and then check the box to enable the function.





Step 3 Click **Setting** button.

The **Setting** interface is displayed. See Figure 4-153.

Figure 4-153



Step 4 Set arm/disarm period. There are two modes for you to set the period so that the system can detect the specified zone.

- Define the period by drawing.
  1. Select the corresponding date and then use mouse to drag the bar to set period.
    - ◇ Define for the whole week: Click  next to **All**, all the icon switches to  , you can define the period for all the days simultaneously.
    - ◇ Define for several days of a week: Click  before each day one by one, the icon switches to  . You can define the period for the selected days simultaneously.
- Define the period by editing.
  - 1) Click the  of the corresponding date, and then set the period on the pop-up interface. Click OK to save.
  - ◇ There are six periods for you to set for each day.

- ◇ Under **Copy**, select **All** to apply the settings to all the days of a week, or select specific day(s) that you want to apply the settings to.
- 2) Click **Apply** to save the settings.

**Step 5** Click **Apply** button to complete setup.



After set the heat map parameters, go to **Main Menu > INFO > EVENT > HEAT MAP** to view heat map report. Refer to “4.7.1.8 Heat map” for detailed setup information.

#### 4.7.2.9 ANPR

System uses the video recognition technology to extract the plate number on the surveillance video and then compare it with the specified plate information. System can trigger an alarm once there is a matched result.

You can set different plate recognition rule, alarm linkage actions in different environments (blacklist, whitelist and regular).

**Step 1** Select **Main Menu > AI > PARAMETERS > ANPR**.  
The **ANPR** interface is displayed. See Figure 4-154.

Figure 4-154

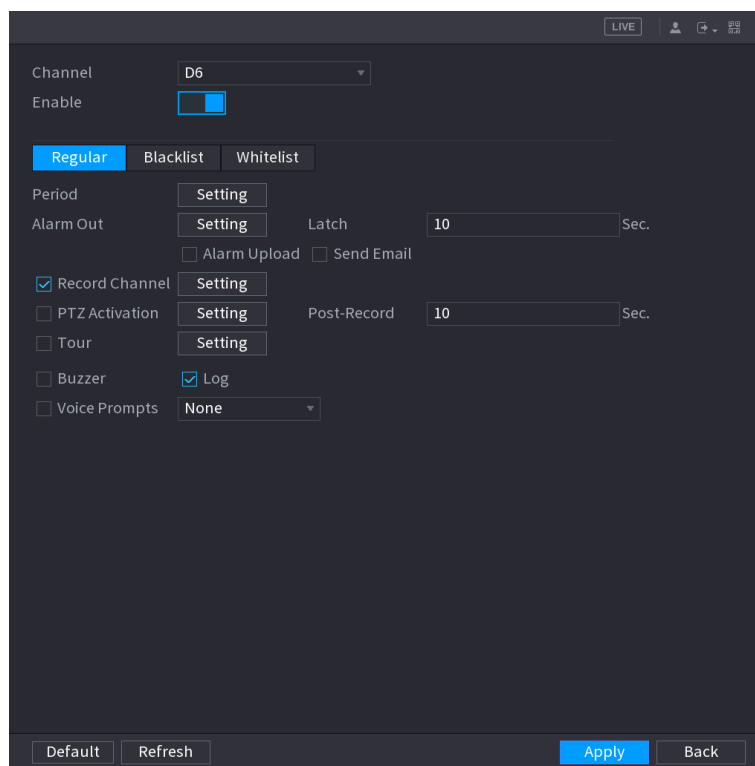

**Step 2** Select the Enable check box to enable ANPR.

**Step 3** Click **Regular** (default), **Blacklist** or **Whitelist** tab to configure it.









Before activate blacklist alarm or whitelist alarm, you need to add the corresponding plate information. Refer to "4.7.3.2 B/W List" for detailed information.

- Regular: Device triggers an alarm when it detects any plate number.
- Blacklist: Device triggers an alarm when it detects plate number in the blacklist.
- Whitelist: Device triggers an alarm when it detects plate number in the whitelist.

**Step 4** Set parameters. See Table 4-42.

Table 4-42

Parameter	Description
Period	Configure the period and in the set time range, the corresponding configuration item will be linked to start the alarm.
Alarm Out	The alarm device (such as lights, sirens, etc.) is connected to the alarm output port. When an alarm occurs, the NVR device transmits the alarm information to the alarm device.

Parameter	Description
Latch	When the alarm ends, the alarm extended for a period of time. The time range is from 0 seconds to 300 seconds.
Alarm Upload	Select the check box. When an alarm occurs, the NVR device uploads an alarm signal to the network (including the alarm center).  <ul style="list-style-type: none"> <li>This function is for some series products only.</li> <li>You need to set the alarm center first. For details, see "4.12.11 Alarm Cente."</li> </ul>
Send Email	Select the check box. When an alarm occurs, the NVR device sends an email to the set mailbox to notify the user.  You need to set the email first. For details, see "4.12.8 Email."
Record Channel	Select the check box and select the needed recording channel (support multiple choices). When an alarm occurs, the NVR device activates the channel for recording.  You need to enable intelligent recording and auto recording first. For details, see "4.1.4.6 Schedule."
PTZ Activation	Select the check box and click <b>Setting</b> to select the channel and PTZ action. When an alarm occurs, the NVR device associates the channel to perform the corresponding PTZ action. For example, activate the PTZ in channel one to turn to the preset point X.  <ul style="list-style-type: none"> <li>Tripwire alarm supports to activate PTZ preset point only.</li> <li>You need to set the corresponding PTZ actions first, see "4.4.3 Configuring PTZ Functions."</li> </ul>
Delay	At the end of the alarm, the recording extends for a period of time. The time range is from 10 seconds to 300 seconds.
Tour	Select the check box and select the channel for tour. When an alarm occurs, the local interface of the NVR device displays the selected channel screen.  <ul style="list-style-type: none"> <li>You need to set the time interval and mode for tour first, see "4.17.2 Tour. "</li> <li>After the tour is over, the preview interface is restored to the screen split mode before the tour.</li> </ul>
Log	Select the check box, the NVR device records the alarm information in the log when an alarm occurs.
Voice Prompts	Check the box and then select the corresponding audio file from the dropdown list. System plays the audio file when the alarm occurs.  Refer to "4.18.1 File Manage " to add audio file first.
Buzzer	Select the check box to activate the buzzer when an alarm occurs.

**Step 5** Click **Apply**.

### 4.7.3 Database

After you successfully set the face library, the detected human face can compare with the image on the face library. The face library settings include create face library, add human face and human face modeling.



For privacy reason, the human face is pixelated.

#### 4.7.3.1 Creating Human Face Library

**Step 1** Select **Main Menu > AI > DATABASE > FACE LIBRARY**.

The **FACE LIBRARY** interface is displayed. See Figure 4-155.

Figure 4-155

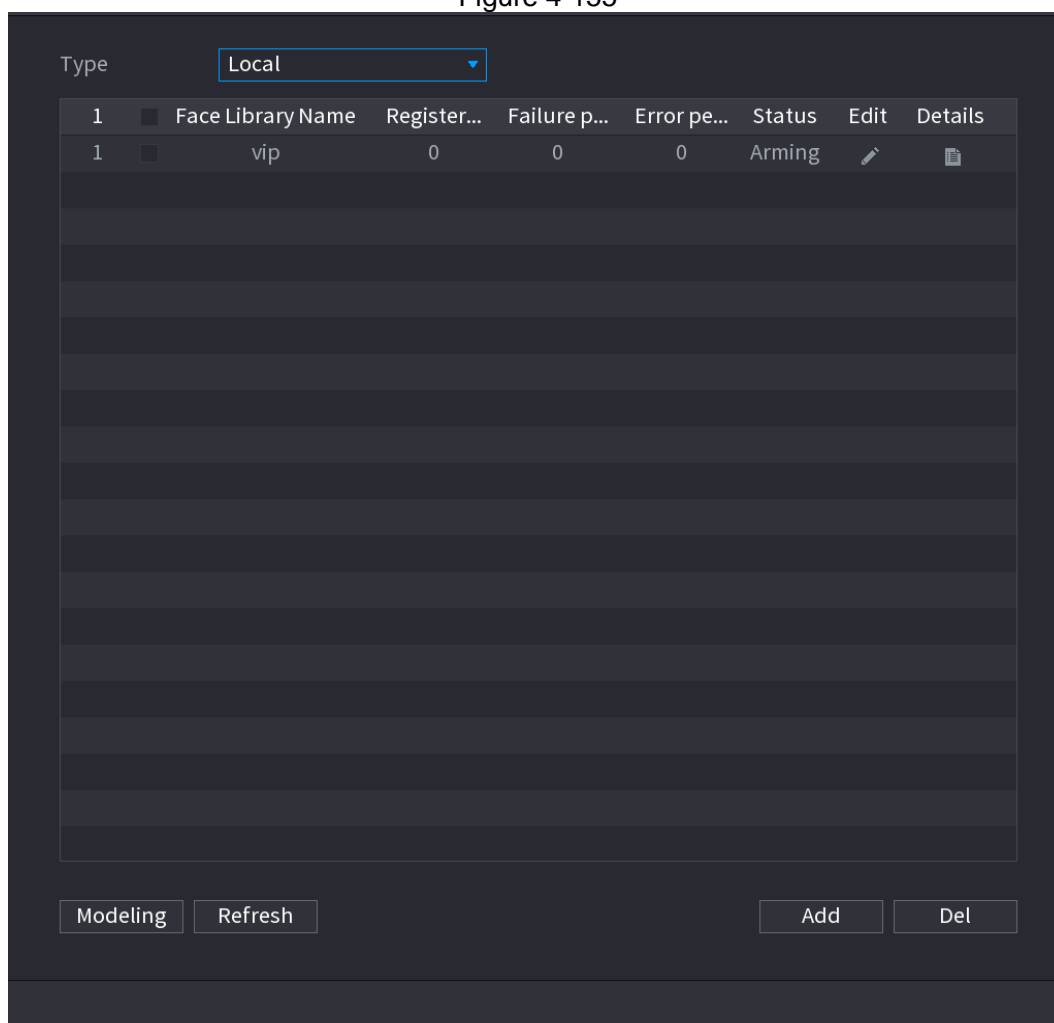

**Step 2** Select a channel and then click **Add**.  
System displays **Add** interface. See Figure 4-156.

Figure 4-156

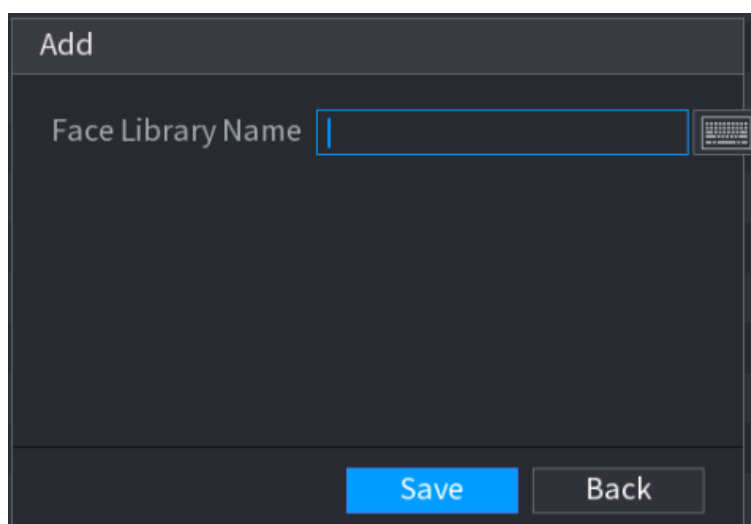

**Step 3** Input human face library name and then click **Save**.  
System successfully saves the face library.

## Adding Face Pictures

You can add face pictures to the existing libraries one by one or by batch, or add from the detected faces.



To add face pictures one by one or by batch, you need to get the pictures from the USB storage device. The picture size should be smaller than 256K with resolution between 200×200–6000×5000.

## Adding One Face Picture

You can add one face picture to the database. It is for the scenario that the registered human face picture amount is small.

**Step 1** Select **Main Menu > AI > DATABASE > FACE LIBRARY**.

The **FACE LIBRARY** interface is displayed.

**Step 2** Click  of the library that you want to configure.

The **Details** interface is displayed. See Figure 4-157.

Figure 4-157

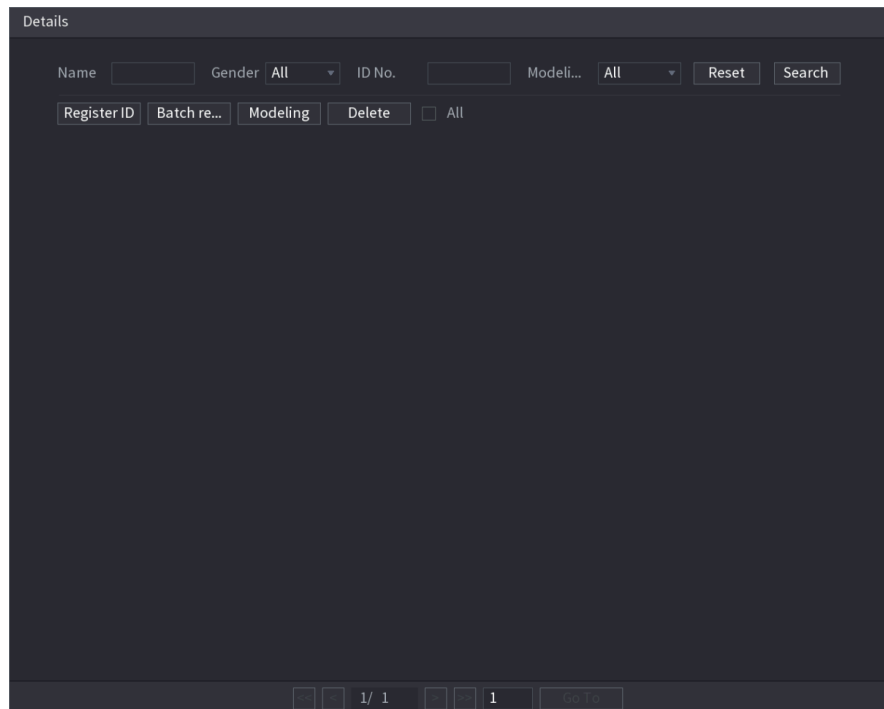

**Step 3** Click **Register ID**.

The **Register ID** interface is displayed. See Figure 4-158.

Figure 4-158

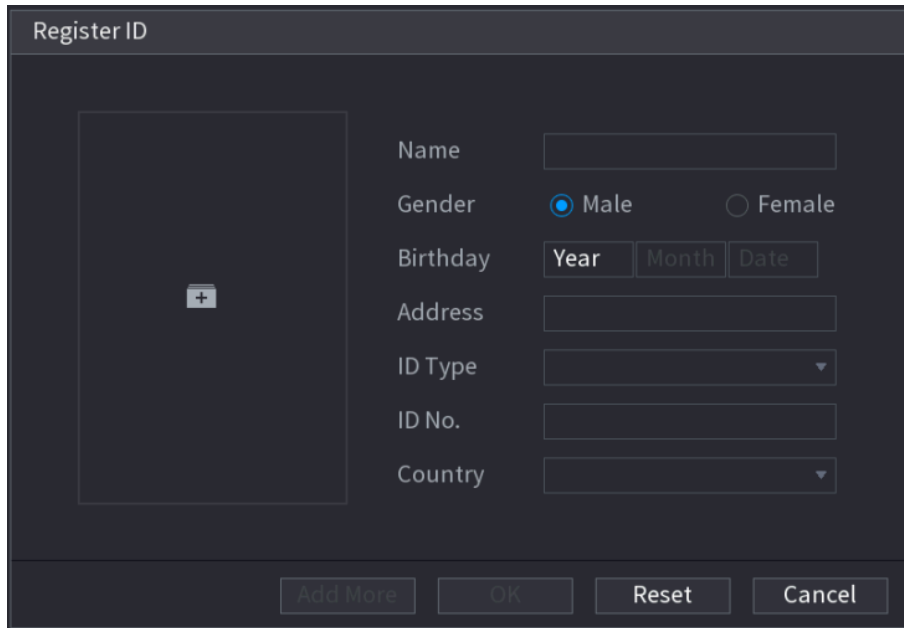

The 'Register ID' form contains the following fields and controls:

- Name: Text input field
- Gender: Radio buttons for Male (selected) and Female
- Birthdate: Three input fields for Year, Month, and Date
- Address: Text input field
- ID Type: Dropdown menu
- ID No.: Text input field
- Country: Dropdown menu
- Image placeholder: A large box with a '+' icon for adding a face picture.
- Buttons: Add More, OK, Reset, and Cancel.



**Step 4** Click  to add a face picture. The **Browse** interface is displayed. See Figure 4-159.

Figure 4-159

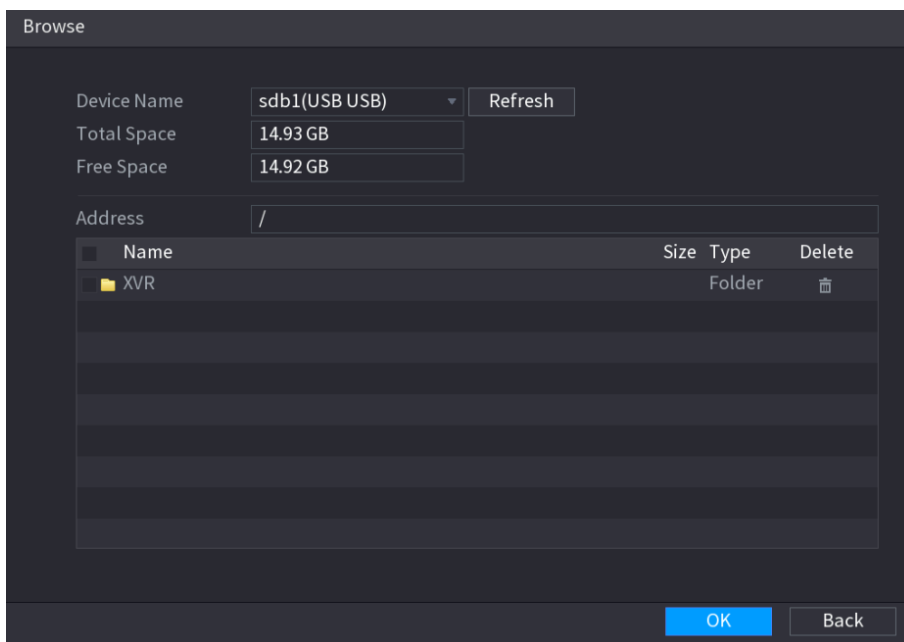

The 'Browse' interface displays the following information:

- Device Name: sdb1(USB USB) with a Refresh button.
- Total Space: 14.93 GB
- Free Space: 14.92 GB
- Address: /
- File list table:

Name	Size	Type	Delete
XVR		Folder	

Buttons: OK and Back.

**Step 5** Select a face picture and enter the registration information. See Figure 4-160.

Figure 4-160

Register ID

Name: margie

Gender:  Male  Female

Birthday: 1996 03 07

Address: TTYUI

ID Type: Passport

ID No.: 1111111111111155555

Country: United States

Buttons: Add More, OK, Reset, Cancel

**Step 6** Click **OK**.

The system prompts the registration is successful.

**Step 7** On the **Details** interface, click **Search**.

The system prompts modeling is successful. See Figure 4-161.



If the system prompts the message indicating modeling is in process, wait a while and then click **Search** again. If modeling is failed, the registered face picture cannot be used for face recognition.

Figure 4-161

Details

Name: [ ] Gender: All ID No.: [ ] Modeli...: All [Reset] [Search]

Buttons: Register ID, Batch re..., Modeling, Delete, [ ] All

Name	Gender	ID No.	Modeli...	Status
nic	Male	[ ]	[ ]	Modeling Successful
margie	Female	1111111111111155555	[ ]	Modeling Successful

Footer: 1/1 [Go To]

## Adding Face Pictures in Batch

System supports batch add if you want to import several human face image at the same time.

**Step 1** Give a name to the face picture by referring to the following table. See Table 4-43.

Table 4-43

Naming format	Description
Name	Enter the name.
Gender	Enter 1 or 2. 1 represents male, and 2 represents female.
Birthday	Enter numbers in the format of yyyy-mm-dd.
Country	Enter the abbreviation of country. For example, CN for China.
ID Type	1 represents ID card; 2 represents passport; 3 represents military officer password.
ID No.	Enter the ID number.
Address	Enter the address.

**Step 2** Select **Main Menu > AI > DATABASE > FACE LIBRARY**.  
The **FACE LIBRARY** interface is displayed.

**Step 3** Click  of the library that you want to configure.  
The **Details** interface is displayed. See Figure 4-157.

**Step 4** On the **Details** interface, click **Batch register**.  
The **Batch register** interface is displayed. See Figure 4-162.  
Figure 4-162

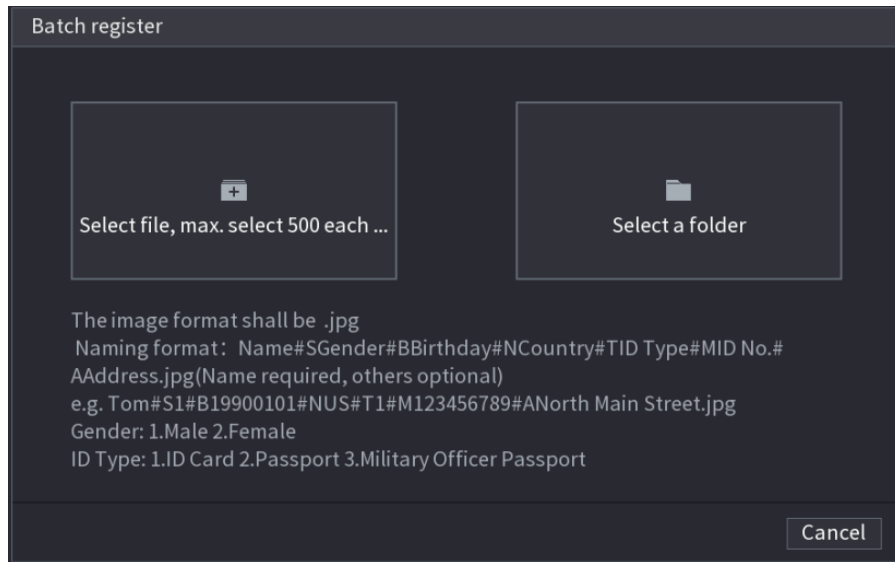

**Step 5** Click **Select file, max select 500 each time** or **Select a folder** to import face pictures.

**Step 6** Click **OK** to complete batch registration.

#### 4.7.3.2 Black/whitelist

To manage vehicle management, you can add the corresponding plate number on the blacklist or whitelist. System can compare the detected plate information with the plate on the blacklist/whitelist and then trigger the corresponding alarm linkage.

After enable black/whitelist, on the preview interface, the plate in the blacklist is displayed as red on the plate list, the plate in the whitelist is displayed as green on the plate list. For the plate not in the black/whitelist, the plate is displayed as white.

### Adding B/W List

**Step 1** Select **Main Menu > AI > DATABASE > B/WLIST**.  
The **B/W List** interface is displayed. See Figure 4-163.



Figure 4-163

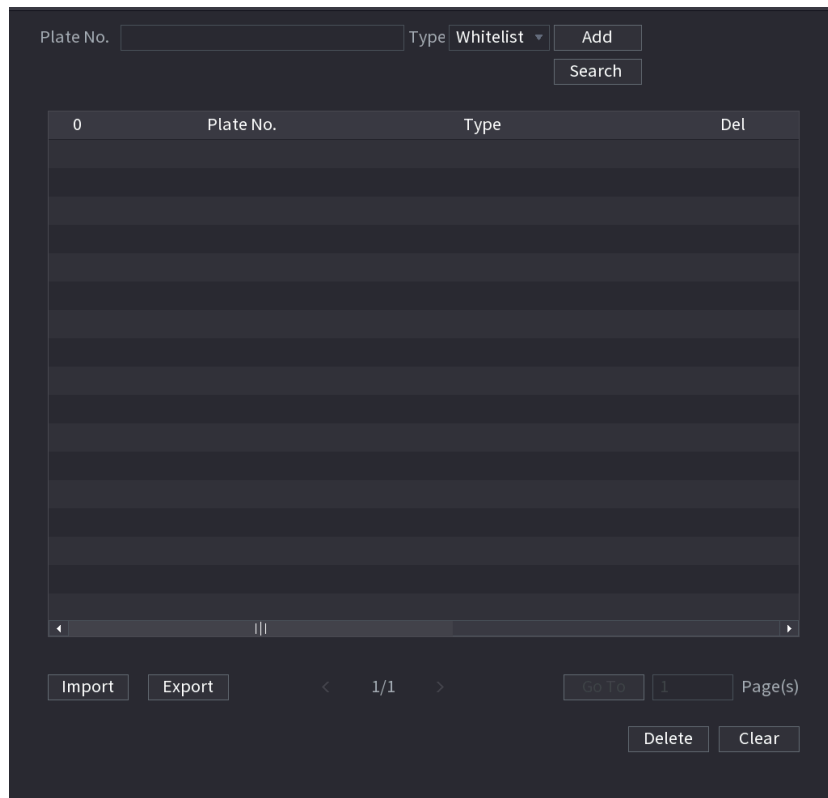

**Step 2** Set plate information and then select **Blacklist** or **Whitelist**.

**Step 3** Click **Add**.

## Deleting Black/Whitelist

Set type as **Whitelist**, **Blacklist**, or **All**, and then click **Search**. System displays black/whitelist information. See Figure 4-164.

- On the searched results list, check the box before the plate number and then click **Delete**, or click the  of the corresponding plate number, you can delete the plate information on the black/whitelist.
- Click **Clear** to delete all plate information on the black/whitelist.

Figure 4-164



## Import/Export Black/whitelist

System supports export black/whitelist to the USB device, or import black/whitelist from the USB device. System supports .csv or .xlsx file. The export file format is .csv.

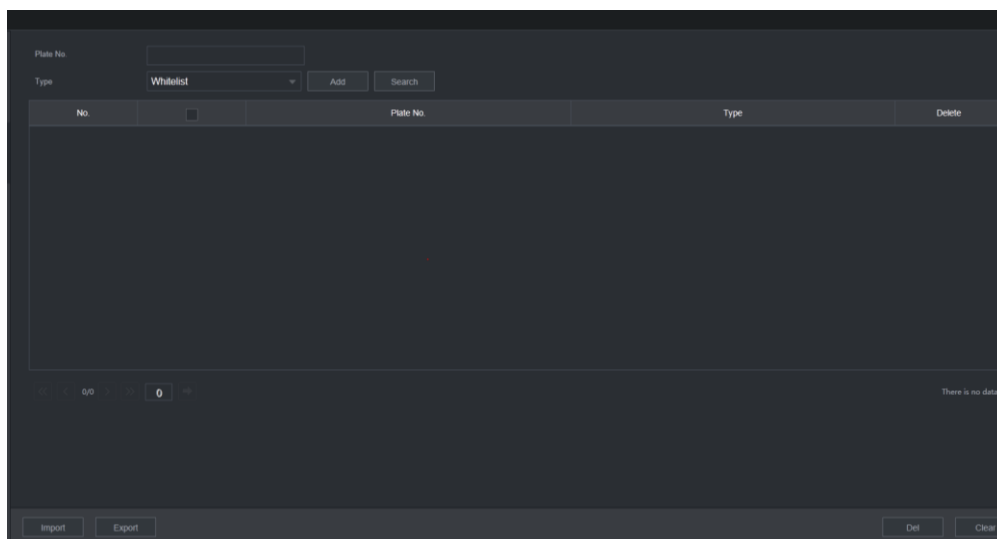
- Import black/whitelist: Click **Import** and then select the corresponding file, click **Browse** to import the file.
- Export black/whitelist: Click **Export** and then select the file storage path and then click **Save**.

## 4.8 Event Manager

### 4.8.1 Alarm Info

You can search, view and back up the alarm information.

**Step 1** Select **Main Menu > ALARM > ALARM INFO**.

The **ALARM INFO** interface is displayed. See Figure 4-165.

Figure 4-165

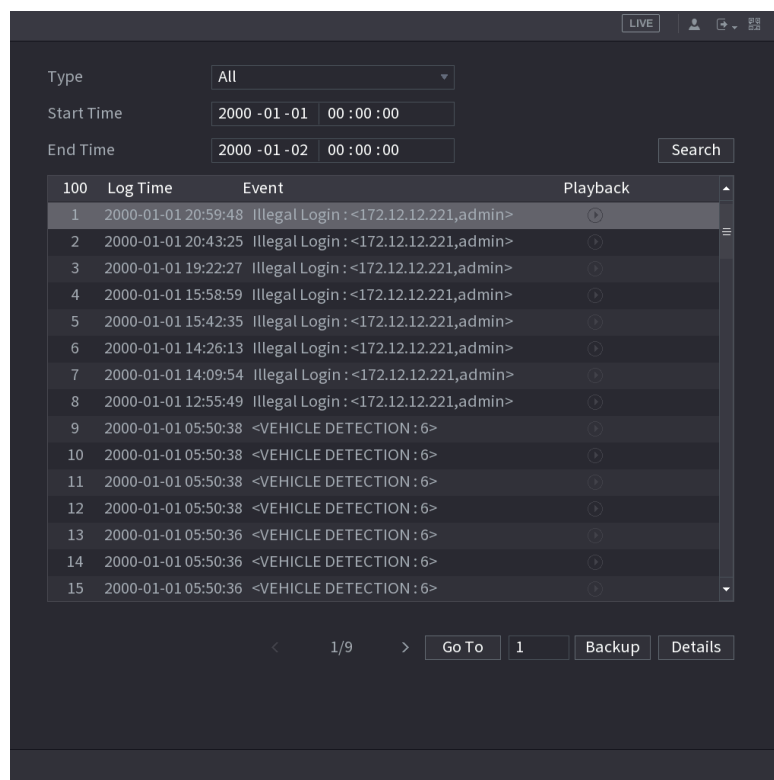

**Step 4** In the **Type** list, select the event type; In the **Start Time** box and **End Time** box, enter the specific time.

**Step 5** Click **Search**.

The search results are displayed.

**Step 6** Click **Backup** to back up the search results into the external storage device.



- Select an alarm event log and then click **Backup** to back up it to peripheral USB device.
- Select an alarm event log, click  to play the recorded video of alarm event. Double-click a log or click **Details** to view the detailed information of the event.

### 4.8.2 Alarm Status

You can view NVR alarm event, and remote channel alarm event.

Select **Main Menu > ALARM > ALARM STATUS**, the **ALARM STATUS** interface is displayed. See Figure 4-166.









Figure 4-167

Local	Net	IPC Ext	IPC Offline
Alarm In	1	Alarm Name	Alarm In1
Enable	<input checked="" type="checkbox"/>	Type	NO
Period	Setting	Anti-Dither	5 s
Alarm Out	Setting	Latch	10 s
<input type="checkbox"/> Show Message	<input type="checkbox"/> Alarm Upload	<input type="checkbox"/> Send Email	
<input type="checkbox"/> Record Channel	Setting		
<input type="checkbox"/> PTZ Activation	Setting	Post-Record	10 s
<input type="checkbox"/> Tour	Setting	<input type="checkbox"/> Picture Storage	Setting
<input type="checkbox"/> Buzzer	<input checked="" type="checkbox"/> Log		
<input type="checkbox"/> Voice Prompts	None		
Default		Apply	Back

**Step 3** Set **Alarm In** channel number and then select the **Enable check** box to enable the function.

**Step 4** Configure parameters. See Table 4-44.  
Table 4-44

Parameter	Description
Alarm in	Select a channel to set alarm.
Enable	Check the box <input checked="" type="checkbox"/> to enable the function.
Alarm Name	Enter an alarm name.
Type	NO (normal open) or NC (normal close).
Period	Define a period during which the alarm is active. For details, see "Setting Period in 4.8.5.1 Motion Detect."
Alarm Out	The alarm device (such as lights, sirens, etc.) is connected to the alarm output port. When an alarm occurs, the NVR device transmits the alarm information to the alarm device.
Latch	When the alarm ends, the alarm extended for a period of time. The time range is from 0 seconds to 300 seconds.
Show Message	Check box to enable a pop-up message in your local host PC.

Parameter	Description
Alarm Upload	<p>Select the check box. When an alarm occurs, the NVR device uploads an alarm signal to the network (including the alarm center).</p>  <ul style="list-style-type: none"> <li>This function is for some series products only.</li> <li>You need to set the alarm center first. For details, see "4.12.11 Alarm Cente."</li> </ul>
Send Email	<p>Select the check box. When an alarm occurs, the NVR device sends an email to the set mailbox to notify the user.</p>  <p>You need to set the email first. For details, see "4.12.8 Email."</p>
Record Channel	<p>Select the check box and select the needed recording channel (support multiple choices). When an alarm occurs, the NVR device activates the channel for recording.</p>  <p>You need to enable intelligent recording and auto recording first. For details, see "4.1.4.6 Schedule."</p>
PTZ Activation	<p>Select the check box and click <b>Setting</b> to select the channel and PTZ action. When an alarm occurs, the NVR device associates the channel to perform the corresponding PTZ action. For example, activate the PTZ in channel one to turn to the preset point X.</p>  <ul style="list-style-type: none"> <li>Tripwire alarm supports to activate PTZ preset point only.</li> <li>You need to set the corresponding PTZ actions first, see "4.4.3 Configuring PTZ Functions."</li> </ul>
Delay	<p>At the end of the alarm, the recording extends for a period of time. The time range is from 10 seconds to 300 seconds.</p>
Tour	<p>Select the check box and select the channel for tour. When an alarm occurs, the local interface of the NVR device displays the selected channel screen.</p>  <ul style="list-style-type: none"> <li>You need to set the time interval and mode for tour first, see "4.17.2 Tour. "</li> <li>After the tour is over, the preview interface is restored to the screen split mode before the tour.</li> </ul>
Log	<p>Select the check box, the NVR device records the alarm information in the log when an alarm occurs.</p>
Voice Prompts	<p>Check the box and then select the corresponding audio file from the dropdown list. System plays the audio file when the alarm occurs.</p>  <p>Refer to "4.18.1 File Manage " to add audio file first.</p>
Buzzer	<p>Select the check box to activate the buzzer when an alarm occurs.</p>
Record Channel	<p>Select the check box and select the needed recording channel (support multiple choices). When an alarm occurs, the NVR device activates the channel for recording.</p>  <p>You need to enable intelligent recording and auto recording first. For details, see "4.1.4.6 Schedule."</p>

Step 5 Click **Apply**.

#### 4.8.4 Alarm Control

You can set proper alarm output (Auto/manual/off). Connect the alarm device to the system

alarm output port, and set the mode as auto, system can trigger the corresponding operations when an alarm occurs.

- Auto: Once an alarm event occurs, system can generate an alarm.
- Manual: Alarm device is always on the alarming mode.
- Off: Disable alarm output function.

**Step 1** Select **Main Menu > ALARM > ALARM OUTPUT**.

The **ALARM OUTPUT** interface is displayed. See Figure 4-168.

Figure 4-168

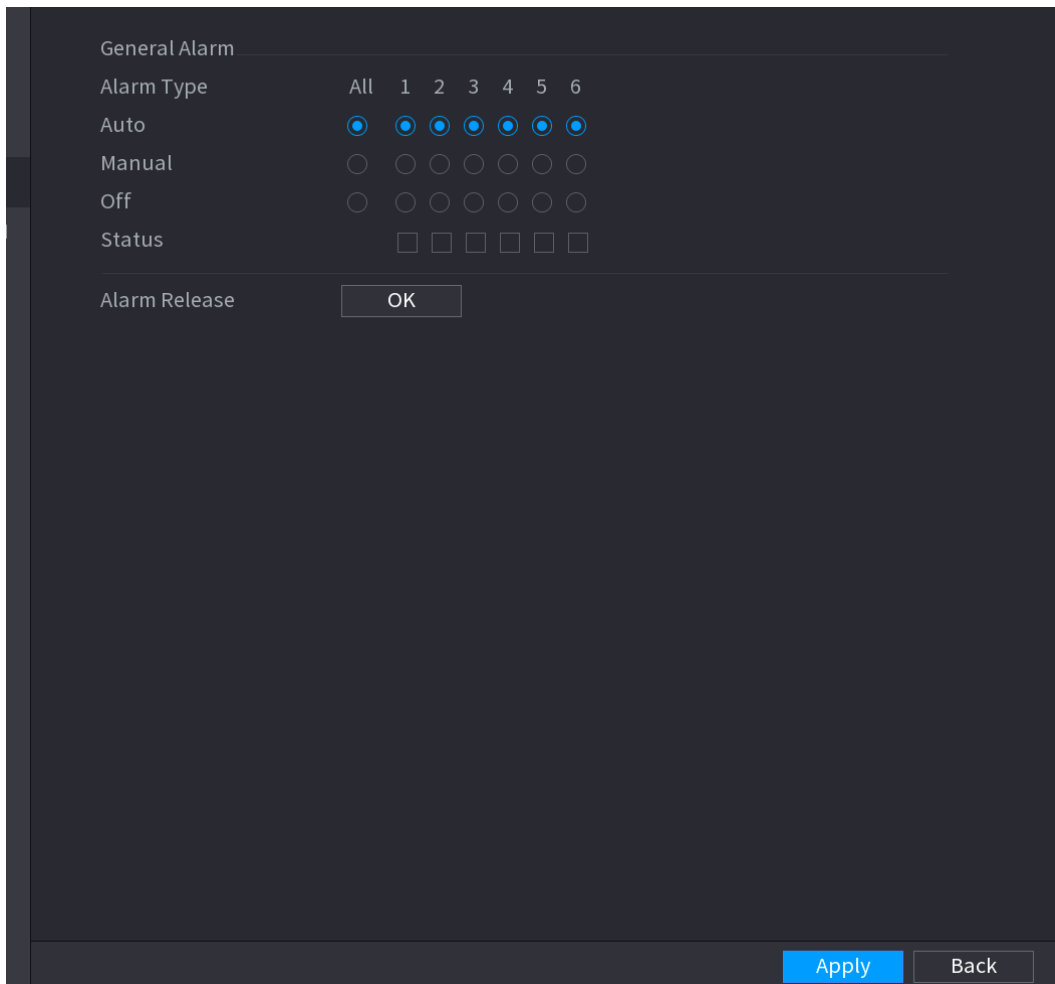

**Step 2** Select the alarm mode of the alarm output channel.

- Click **OK** button of the **Alarm Release**, you can clear all alarm output statuses.
- View the alarm output status on the **Status** column.

**Step 3** Click **Apply**.

## 4.8.5 Video Detection

The video detection adopts the computer image and graphics process technology. It can analyze the video and check there is considerable changing or not. Once video has changed considerably (such as there is any moving object, video is distorted), system can trigger the corresponding alarm activation operations.

Select **Main menu > ALARM > VIDEO DETECTION > MOTION DETECT**, you can see motion detect interface. See Figure 4-171. There are five detection types: motion detection, video loss, tampering, scene changing and PIR alarm.

### 4.8.5.1 Motion Detect

When the moving object appears and moves fast enough to reach the preset sensitivity value, the system activates the alarm.

**Step 1** Select **Main Menu > ALARM > VIDEO DETECTION > Motion Detect**.







The **Motion Detect** interface is displayed. See Figure 4-169.

Figure 4-169

**Step 2** Configure the settings for the motion detection parameters. See Table 4-45.

Table 4-45

Parameter	Description
Channel	In the <b>Channel</b> list, select a channel to set the motion detection.
Region	Click <b>Setting</b> to define the motion detection region.
Enable MD	Enable or disable the motion detection function. Check the box  to enable the function.
Period	Define a period during which the motion detection is active.
Sensitivity	The higher the value is, the easier it is to trigger an alarm. But at the same time, the false alarm may occur. The default value is recommended.
Alarm Out	The alarm device (such as lights, sirens, etc.) is connected to the alarm output port. When an alarm occurs, the NVR device transmits the alarm information to the alarm device.
Latch	When the alarm ends, the alarm extended for a period of time. The time range is from 0 seconds to 300 seconds.
Show Message	Check box to enable a pop-up message in your local host PC.

Parameter	Description
Alarm Upload	Select the check box. When an alarm occurs, the NVR device uploads an alarm signal to the network (including the alarm center).  <ul style="list-style-type: none"> <li>This function is for some series products only.</li> <li>You need to set the alarm center first. For details, see "4.12.11 Alarm Cente."</li> </ul>
Send Email	Select the check box. When an alarm occurs, the NVR device sends an email to the set mailbox to notify the user.  You need to set the email first. For details, see "4.12.8 Email."
Record Channel	Select the check box and select the needed recording channel (support multiple choices). When an alarm occurs, the NVR device activates the channel for recording.  You need to enable intelligent recording and auto recording first. For details, see "4.1.4.6 Schedule."
PTZ Activation	Select the check box and click <b>Setting</b> to select the channel and PTZ action. When an alarm occurs, the NVR device associates the channel to perform the corresponding PTZ action. For example, activate the PTZ in channel one to turn to the preset point X.  <ul style="list-style-type: none"> <li>Tripwire alarm supports to activate PTZ preset point only.</li> <li>You need to set the corresponding PTZ actions first, see 4.4.3 Configuring PTZ Functions.</li> </ul>
Delay	At the end of the alarm, the recording extends for a period of time. The time range is from 10 seconds to 300 seconds.
Tour	Select the check box and select the channel for tour. When an alarm occurs, the local interface of the NVR device displays the selected channel screen.  <ul style="list-style-type: none"> <li>You need to set the time interval and mode for tour first, see 4.17.2 Tour.</li> <li>After the tour is over, the preview interface is restored to the screen split mode before the tour.</li> </ul>
Snapshot	Select the <b>Snapshot</b> check box to take a snapshot of the selected channel.  To use this function, select <b>Main Menu &gt; CAMERA &gt; ENCODE &gt; Snapshot</b> , in the <b>Mode</b> list, select <b>Event (Trigger)</b> .
Voice Prompts	Check the box and then select the corresponding audio file from the dropdown list. System plays the audio file when the alarm occurs.  Refer to 4.18.1 File Manage to add audio file first.
Buzzer	Select the check box to activate the buzzer when an alarm occurs.

**Step 3** Click **Apply** to save the settings.



- Click **Default** to restore the default setting.
- Click **Copy**, in the **Copy** dialog box, select the additional channel(s) that you want to copy the motion detection settings to, and then click **Apply**.
- Click **Test** to test the settings.

## Setting the Motion Detection Region

**Step 1** Next to **Region**, click **Setting**.



- The region setting screen is displayed.
- Step 2** Point to the middle top of the interface.  
The setting interface is displayed. See Figure 4-170.

Figure 4-170

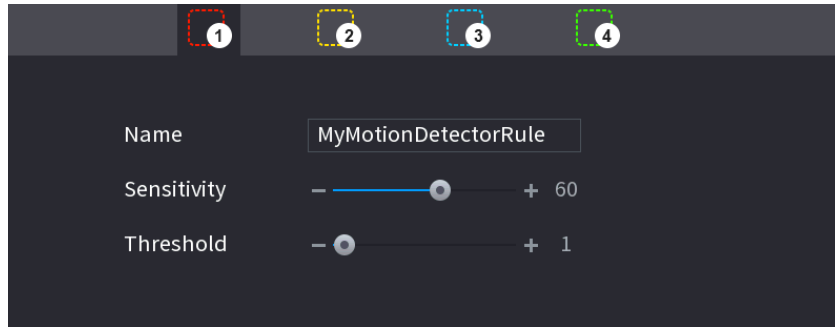

- Step 3** Configure the regions settings. You can configure totally four regions.

- 1) Select one region, for example, click .
- 2) Drag on the screen to select the region that you want to detect.
- 3) The selected area shows the color that represents the region.
- 4) Configure the parameters. See Table 4-46.

Table 4-46

Parameter	Description
Name	Enter a name for the region.
Sensitivity	Every region of every channel has an individual sensitivity value. The bigger the value is, the easier the alarms can be activated.
Threshold	Adjust the threshold for motion detect. Every region of every channel has an individual threshold.



When anyone of the four regions activates motion detect alarm, the channel where this region belongs to will activate motion detect alarm.

- Step 4** Right-click on the screen to exit the region setting interface.
- Step 5** On the **Motion Detect** interface, click **Apply** to complete the settings.

## Setting Period







The system only activates the alarm in the defined period.

- Step 1** Next to **Period**, click **Setting**.  
The **Setting** interface is displayed. See Figure 4-171.

Figure 4-171



**Step 2** Define the motion detection period. By default, it is active all the time.

- Define the period by drawing.
  - ◇ Define for a specified day of a week: On the timeline, click the half-hour blocks to select the active period.
  - ◇ Define for several days of a week: Click  before each day, the icon switches to . On the timeline of any selected day, click the half-hour blocks to select the active periods, all the days with  will take the same settings.
  - ◇ Define for all days of a week: Click **All**, all  switches to . On the timeline of any day, click the half-hour blocks to select the active periods, all the days will take the same settings.
- Define the period by editing. Take Sunday as an example.

- 1) Click . The **Period** interface is displayed. See Figure 4-172.

Figure 4-172



- 2) Enter the time frame for the period, and then select the check box to enable the settings.
  - ◇ There are six periods for you to set for each day.
  - ◇ Under **Copy**, select **All** to apply the settings to all the days of a week, or select specific day(s) that you want to apply the settings to.
- 3) Click **OK** to save the settings.

**Step 3** On the **Motion Detect** interface, click **Apply** to complete the settings.

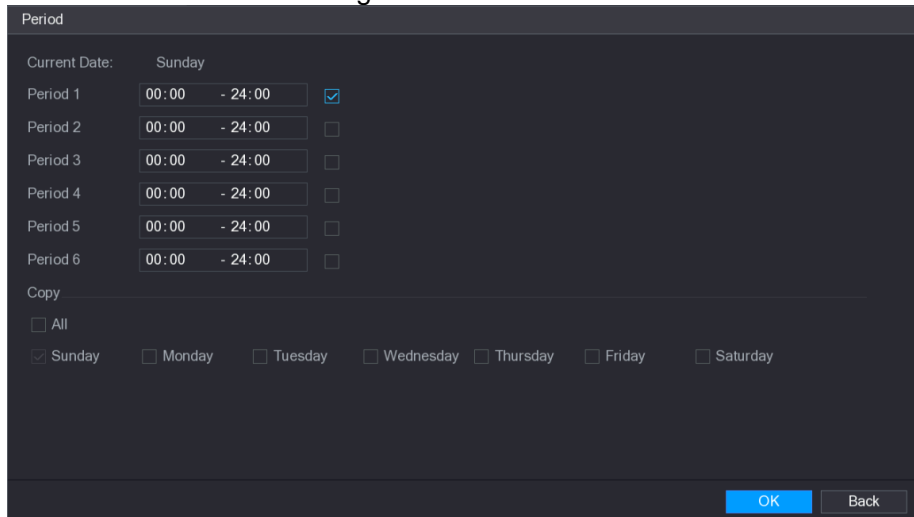
#### 4.8.5.2 Tampering

When the camera lens is covered, or the video is displayed in a single color because of sunlight

status, the monitoring cannot be continued normally. To avoid such situations, you can configure the tampering alarm settings.

**Step 1** Select **Main Menu > ALARM > VIDEO DETECTION > Tampering**.  
The **Tampering** interface is displayed. See Figure 4-173.

Figure 4-173

**Step 2** To configure the settings for the tampering detection parameters, see “4.8.5.1 Motion Detect.”

The Tampering function does not have region and sensitivity items.

**Step 3** Click **Apply** to complete the settings.



- Click **Default** to restore the default setting.
- Click **Copy**, in the **Copy** dialog box, select the additional channel(s) that you want to copy the motion detection settings to, and then click **Apply**.

#### 4.8.5.3 Video Loss

When the video loss occurs, the system activates the alarm.

**Step 1** Select **Main Menu > ALARM > VIDEO DETECTION > Video Loss**.  
The **Video Loss** interface is displayed. See Figure 4-174.

Figure 4-174

**Step 2** To configure the settings for the video loss detection parameters, see “4.8.5.1 Motion Detect.”

The video loss function does not have region and sensitivity items.

**Step 3** Click **Apply** to complete the settings.



- Click **Default** to restore the default setting.
- Click **Copy**, in the **Copy** dialog box, select the additional channel(s) that you want to copy the motion detection settings to, and then click **Apply**.

#### 4.8.5.4 Scene Change

When the detected scene has changed, system can generate an alarm.

**Step 1** Select **Main Menu>ALARM >VIDEO DETECTION >SCENE CHANGE**, The **Scene Change** interface is displayed. See Figure 4-175.

Figure 4-175

**Step 2** To configure the settings for the scene change parameters, see “4.8.5.1 Motion Detect.” The scene change function does not have region and sensitivity items.

**Step 3** Click **Apply** to complete the settings.



- Click **Default** to restore the default setting.
- Click **Copy**, in the **Copy** dialog box, select the additional channel(s) that you want to copy the motion detection settings to, and then click **Apply**.

#### 4.8.5.5 PIR Alarm

When the detected scene has changed, system can generate an alarm.

PIR function helps enhancing the accuracy and validity of motion detect. It can filter the meaningless alarms that are activated by the objects such as falling leaves, flies. The detection range by PIR is smaller than the field angle.

PIR function is enabled by default if it is supported by the cameras. Enabling PIR function will get the motion detect to be enabled automatically to generate motion detection alarms; if the PIR function is not enabled, the motion detect just has the general effect.

**Step 1** Select **Main Menu > ALARM > VIDEO DETECT > PIR ALARM**. The **PIR Alarm** interface is displayed. See Figure 4-176.

Figure 4-176

**Step 2** To configure the settings for the PIR alarm parameters, see “4.8.5.1 Motion Detect.”

**Step 3** Click **Apply** to complete the settings.



- Click **Default** to restore the default setting.
- Click **Copy**, in the **Copy** dialog box, select the additional channel(s) that you want to copy the motion detection settings to, and then click **Apply**.

#### 4.8.6 Audio Detect

System can generate an alarm once it detect the audio is not clear, the tone color has changed or there is abnormal or audio volume changes.

**Step 1** Select **Main Menu > ALARM > AUDIO DETECT**.

The **AUDIO DETECT** interface is displayed. See Figure 4-177.

Figure 4-177

Channel: D1

Input Abnormal  Intensity Change

Sensitivity: [Slider] 1(1 - 100)

Threshold: [Slider] 1(1 - 100)

---

Period: [Setting]

Alarm Out: [Setting] Latch: 10 s

Show Message  Alarm Upload  Send Email

Record Channel [Setting]

PTZ Activation [Setting] Post-Record: 10 s

Tour [Setting]  Picture Storage

Buzzer  Log







Voice Prompts: None

[Default] [Refresh] [Apply] [Back]

Step 2 Configure parameters. See Table 4-47.

Table 4-47

Parameter	Description
Channel	In the <b>Channel</b> list, select a channel to set.
Input abnormal	Check the box here, system can generate an alarm once the audio input is abnormal.
Intensity change	Check the box here, system can generate an alarm once the audio volume becomes strong.
Period	Define a period during which the function is active.
Sensitivity	The higher the value is, the easier it is to trigger an alarm. But at the same time, the false alarm may occur. The default value is recommended.
Threshold	You can set intensity change threshold. The smaller the value is, the higher the sensitivity is.
Alarm Out	The alarm device (such as lights, sirens, etc.) is connected to the alarm output port. When an alarm occurs, the NVR device transmits the alarm information to the alarm device.
Latch	When the alarm ends, the alarm extended for a period of time. The time range is from 0 seconds to 300 seconds.
Show Message	Check box to enable a pop-up message in your local host PC.

Parameter	Description
Alarm Upload	<p>Select the check box. When an alarm occurs, the NVR device uploads an alarm signal to the network (including the alarm center).</p>  <ul style="list-style-type: none"> <li>This function is for some series products only.</li> <li>You need to set the alarm center first. For details, see "4.12.11 Alarm Cente."</li> </ul>
Send Email	<p>Select the check box. When an alarm occurs, the NVR device sends an email to the set mailbox to notify the user.</p>  <p>You need to set the email first. For details, see "4.12.8 Email."</p>
Record Channel	<p>Select the check box and select the needed recording channel (support multiple choices). When an alarm occurs, the NVR device activates the channel for recording.</p>  <p>You need to enable intelligent recording and auto recording first. For details, see "4.1.4.6 Schedule."</p>
PTZ Activation	<p>Select the check box and click <b>Setting</b> to select the channel and PTZ action. When an alarm occurs, the NVR device associates the channel to perform the corresponding PTZ action. For example, activate the PTZ in channel one to turn to the preset point X.</p>  <ul style="list-style-type: none"> <li>Tripwire alarm supports to activate PTZ preset point only.</li> <li>You need to set the corresponding PTZ actions first, see "4.4.3 Configuring PTZ Functions."</li> </ul>
Delay	<p>At the end of the alarm, the recording extends for a period of time. The time range is from 10 seconds to 300 seconds.</p>
Tour	<p>Select the check box and select the channel for tour. When an alarm occurs, the local interface of the NVR device displays the selected channel screen.</p>  <ul style="list-style-type: none"> <li>You need to set the time interval and mode for tour first, see "4.17.2 Tour. "</li> <li>After the tour is over, the preview interface is restored to the screen split mode before the tour.</li> </ul>
Log	<p>Select the check box, the NVR device records the alarm information in the log when an alarm occurs.</p>
Voice Prompts	<p>Check the box and then select the corresponding audio file from the dropdown list. System plays the audio file when the alarm occurs.</p>  <p>Refer to "4.18.1 File Manage " to add audio file first.</p>
Buzzer	<p>Select the check box to activate the buzzer when an alarm occurs.</p>
Record Channel	<p>Select the check box and select the needed recording channel (support multiple choices). When an alarm occurs, the NVR device activates the channel for recording.</p>  <p>You need to enable intelligent recording and auto recording first. For details, see "4.1.4.6 Schedule."</p>

Step 3 Click **Apply** to complete the settings.

#### 4.8.7 Thermal Alarm

System supports thermal devices and receives the alarm signal from it. It can recognize the



alarm type, and then trigger the corresponding alarm actions.

The system supports fire alarm, temperature (temperature difference) and cold/hot alarm.

- Fire alarm: System generates an alarm once it detects there is a fire. The alarm mode includes Preset and Excluded zone.
- Temperature (temperature difference): System triggers an alarm once the temperature difference between two positions is higher or below the specified threshold.
- Cold/hot alarm: System triggers an alarm once the detected position temperature is higher or below the specified threshold.



- The connected channel shall support temperature test function.
- This function is for some series products only. It supports enable/disable function only. Go to the front-end device to set corresponding parameters.

**Step 1** Select **Main Menu > ALARM > THERMAL ALARM**.

The **THERMAL ALARM** interface is displayed. See Figure 4-178.

Figure 4-178

Channel: D1  
Alarm Type: Smog Alarm  
Period: Setting  
Alarm Out: Setting, Latch: 0 Sec., Alarm Upload, Send Email  
Record Channel: Setting  
PTZ Activation: Setting, Post-Record: 10 Sec.  
Tour: Setting  
Picture Storage  
Buzzer: Log  
Voice Prompts: [Dropdown]  
Default, Apply, Back







**Step 2** Select a channel and alarm type, enable the thermal alarm function.

**Step 3** Select fire mode and then enable this function (If the alarm type is **Fire Alarm**). System supports preset mode and zone excluded mode.

- **Preset:** Select a preset and then enable the function. System generates an alarm once it detect there is a fire.
- **Global:** System filters the specified high temperature zone. System generates an alarm once the rest zone has fire.

**Step 4** Set parameters. See Table 4-48.

Table 4-48

Parameter	Description
Alarm Out	The alarm device (such as lights, sirens, etc.) is connected to the alarm output port. When an alarm occurs, the NVR device transmits the alarm information to the alarm device.
Latch	When the alarm ends, the alarm extended for a period of time. The time range is from 0 seconds to 300 seconds.
Show Message	Check box to enable a pop-up message in your local host PC.
Alarm Upload	Select the check box. When an alarm occurs, the NVR device uploads an alarm signal to the network (including the alarm center).  <ul style="list-style-type: none"> <li>This function is for some series products only.</li> <li>You need to set the alarm center first. For details, see "4.12.11 Alarm Cente."</li> </ul>
Send Email	Select the check box. When an alarm occurs, the NVR device sends an email to the set mailbox to notify the user.  <p>You need to set the email first. For details, see "4.12.8 Email."</p>
Record Channel	Select the check box and select the needed recording channel (support multiple choices). When an alarm occurs, the NVR device activates the channel for recording.  <p>You need to enable intelligent recording and auto recording first. For details, see "4.1.4.6 Schedule."</p>
PTZ Activation	Select the check box and click <b>Setting</b> to select the channel and PTZ action. When an alarm occurs, the NVR device associates the channel to perform the corresponding PTZ action. For example, activate the PTZ in channel one to turn to the preset point X.  <ul style="list-style-type: none"> <li>Tripwire alarm supports to activate PTZ preset point only.</li> <li>You need to set the corresponding PTZ actions first, see "4.4.3 Configuring PTZ Functions."</li> </ul>
Delay	At the end of the alarm, the recording extends for a period of time. The time range is from 10 seconds to 300 seconds.
Tour	Select the check box and select the channel for tour. When an alarm occurs, the local interface of the NVR device displays the selected channel screen.  <ul style="list-style-type: none"> <li>You need to set the time interval and mode for tour first, see "4.17.2 Tour. "</li> <li>After the tour is over, the preview interface is restored to the screen split mode before the tour.</li> </ul>
Log	Select the check box, the NVR device records the alarm information in the log when an alarm occurs.
Voice Prompts	Check the box and then select the corresponding audio file from the dropdown list. System plays the audio file when the alarm occurs.  <p>Refer to "4.18.1 File Manage " to add audio file first.</p>
Buzzer	Select the check box to activate the buzzer when an alarm occurs.

Parameter	Description
Record Channel	Select the check box and select the needed recording channel (support multiple choices). When an alarm occurs, the NVR device activates the channel for recording.  You need to enable intelligent recording and auto recording first. For details, see "4.1.4.6 Schedule."

**Step 5** Click **Apply**.

#### 4.8.8 Abnormality

**Step 1** Select **Main Menu>ALARM>ABNORMALITY**.

The **Abnormality** interface is displayed. See Figure 4-179.

Figure 4-179

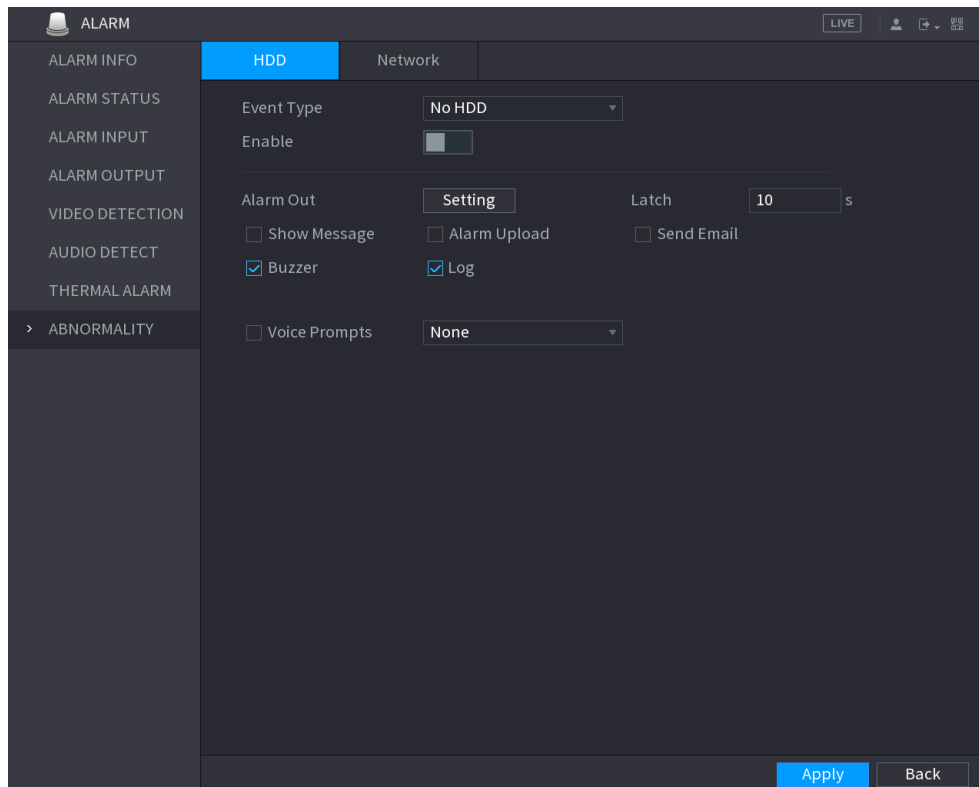









Figure 4-180

The screenshot shows a configuration interface for network events. At the top, there are tabs for 'HDD', 'Network' (selected), 'User', and 'Device'. Below the tabs, the 'Event Type' is set to 'Net Disconnection'. The 'Enable' checkbox is checked. The 'Alarm Out' is set to 'Setting', 'Latch' is set to '10' seconds, and 'Show Message' is unchecked. 'Buzzer' and 'Voice Prompts' are unchecked, while 'Log' is checked and 'Voice Prompts' is set to 'None'. 'Apply' and 'Back' buttons are at the bottom right.

Step 2 Configure parameters. See Table 4-49.

Table 4-49

Parameter	Description
Event Type	<p>Click the corresponding tab to set different abnormality events.</p> <ul style="list-style-type: none"> <li>● HDD: Sets process method when there is a HDD event such as HDD error, no HDD, no space. See Figure 4-179.</li> <li>● Network: Sets process method when there is a network event such as disconnection, IP conflict, MAC conflict. See Figure 4-179.</li> </ul> <p> Different series products support different event types. The actual product shall prevail.</p>
Enable	Check the box to enable the function,
Less than	<p>System generates an alarm once the HDD space is less than the threshold.</p> <p> For <b>HDD Space</b> type only.</p>
Alarm Out	The alarm device (such as lights, sirens, etc.) is connected to the alarm output port. When an alarm occurs, the NVR device transmits the alarm information to the alarm device.
Latch	When the alarm ends, the alarm extended for a period of time. The time range is from 0 seconds to 300 seconds.
Show Message	Check box to enable a pop-up message in your local host PC.

Parameter	Description
Alarm Upload	<p>Select the check box. When an alarm occurs, the NVR device uploads an alarm signal to the network (including the alarm center).</p>  <ul style="list-style-type: none"> <li>This function is for some series products only.</li> <li>You need to set the alarm center first. For details, see "4.12.11 Alarm Cente."</li> </ul>
Send Email	<p>Select the check box. When an alarm occurs, the NVR device sends an email to the set mailbox to notify the user.</p>  <p>You need to set the email first. For details, see "4.12.8 Email."</p>
Record Channel	<p>Select the check box and select the needed recording channel (support multiple choices). When an alarm occurs, the NVR device activates the channel for recording.</p>  <p>You need to enable intelligent recording and auto recording first. For details, see "4.1.4.6 Schedule."</p>
PTZ Activation	<p>Select the check box and click <b>Setting</b> to select the channel and PTZ action. When an alarm occurs, the NVR device associates the channel to perform the corresponding PTZ action. For example, activate the PTZ in channel one to turn to the preset point X.</p>  <ul style="list-style-type: none"> <li>Tripwire alarm supports to activate PTZ preset point only.</li> <li>You need to set the corresponding PTZ actions first, see "4.4.3 Configuring PTZ Functions."</li> </ul>
Tour	<p>Select the check box and select the channel for tour. When an alarm occurs, the local interface of the NVR device displays the selected channel screen.</p>  <ul style="list-style-type: none"> <li>You need to set the time interval and mode for tour first, see "4.17.2 Tour."</li> <li>After the tour is over, the preview interface is restored to the screen split mode before the tour.</li> </ul>
Snapshot	<p>Select the <b>Snapshot</b> check box to take a snapshot of the selected channel.</p>  <p>To use this function, select <b>Main Menu &gt; CAMERA &gt; ENCODE &gt; Snapshot</b>, in the Mode list, select Event (Trigger).</p>
Log	<p>Select the check box, the NVR device records the alarm information in the log when an alarm occurs.</p>
Voice Prompts	<p>Check the box and then select the corresponding audio file from the dropdown list. System plays the audio file when the alarm occurs.</p>  <p>Refer to "4.18.1 File Manage" to add audio file first.</p>
Buzzer	<p>Select the check box to activate the buzzer when an alarm occurs.</p>

Step 3 Click **Apply**.

## 4.9 POS

You can connect the Device to the POS (Point of Sale) machine and receive the information from it. This function applies to the scenarios such as supermarket POS machine. After connection is established, the Device can access the POS information and display the overlaid text in the channel window.



Playing POS information in the local playback and viewing the POS information in the live view screen support single-channel mode and four-channel mode. Displaying monitoring screen and playing back in the web support multi-channel mode.

#### 4.9.1 Search



The system supports fuzzy search.

**Step 1** Select **Main Menu > POS > POS SEARCH**.

The **POS SEARCH** interface is displayed. See Figure 4-181.

Figure 4-181

**Step 2** In the **POS SEARCH** box, enter the information such as transaction number on your receipt, amount, or product name.

**Step 4** In the **Start Time** box and **End Time** box, enter the time period that you want to search the POS transaction information.

**Step 5** Click **Search**.

The searched transaction results display in the table.

#### 4.9.2 Settings

**Step 1** Select **Main Menu > POS > POS SETUP**.



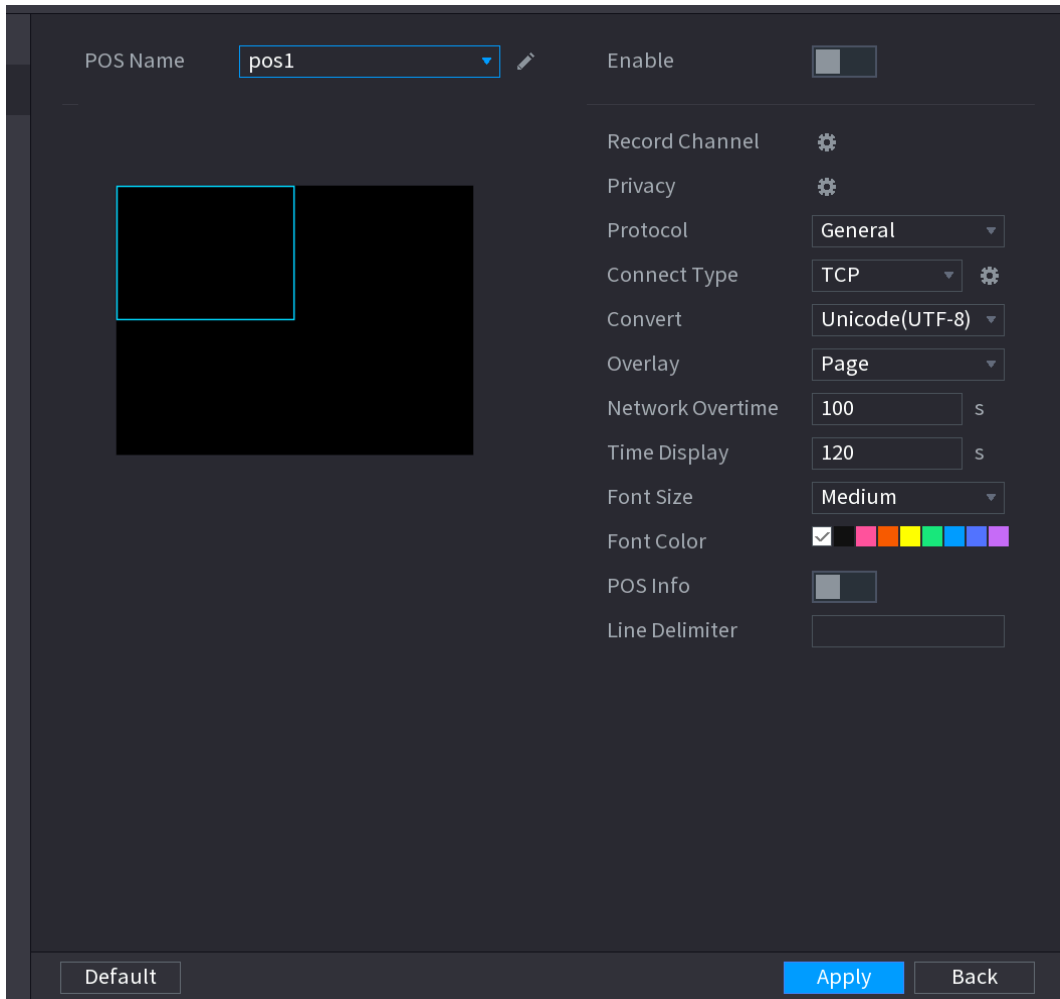

The **POS SETUP** interface is displayed. See Figure 4-182.

Figure 4-182



**Step 2** Configure the settings for the POS parameters. See Table 4-50.

Table 4-50

Parameter	Description
POS Name	In the <b>POS Name</b> list, select the POS machine that you want to configure settings for. Click  to modify the POS name.  <ul style="list-style-type: none"> <li>The POS name shall be unique.</li> <li>The POS name supports 21 Chinese characters or 63 English characters.</li> </ul>
Enable	Enable the POS function.
Record CH	Click  to select a channel to record.
Privacy Setup	Enter the privacy contents. Refer to "4.9.2.1 Privacy Setup".
Protocol Type	Select <b>POS</b> by default. Different machine corresponds to different protocol.
Connect Type	In the <b>Connect Type</b> list, select the connection protocol type. Click  , the IP Address interface is displayed. In the <b>Source IP</b> box, enter the IP address (the machine that is connected to the Device) that sends messages.
Convert	Select a character encoding mode.

Parameter	Description
Overlay	In the <b>Overlay</b> list, Select <b>Turn</b> or <b>ROLL</b> . <ul style="list-style-type: none"> <li>● Turn: Once the information is at 16 lines, system displays the next page.</li> <li>● ROLL: Once the information is at 16 lines, system rolls one line after another to delete the first line.</li> </ul>  When the local preview mode is in 4-split, the turn/ROLL function is based on 8 lines.
Network time out	When the network is not working correctly and cannot be recovered after the entered timeout limit, the POS information will not display normally. After the network is recovered, the latest POS information will be displayed.
Time Display	Enter the time that how long you want to keep the POS information displaying. For example, enter 5, the POS information disappear from the screen after 5 seconds.
Font Size	In the Font Size list, select <b>Small</b> , <b>Medium</b> , or <b>Big</b> as the text size of POS information
COLOR	In the color bar, click to select the color for the text size of POS information.
POS Info	Enable the POS Info function, the POS information displays in the live view/WEB.
Line Delimiter	There is no line delimiter by default. After set the line delimiter (HEX), the overlay information after the delimiter is displayed in the new line. For example, the line delimiter is F and the overlay information is 123156789, NVR displays overlay information on the local preview interface and Web as: 123 6789

Step 3 Click **Apply** to complete the settings.

#### 4.9.2.1 Privacy Setup

Step 1 Click **Setup**

The **Privacy** interface is displayed. See Figure 4-183.

Figure 4-183

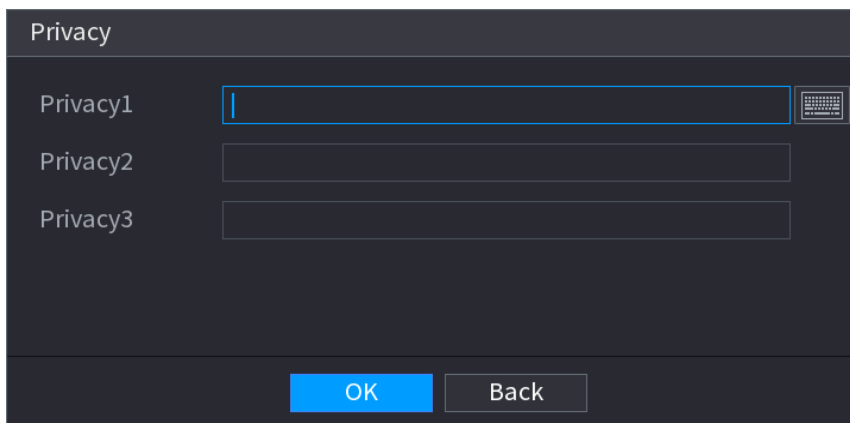

Step 2 Set privacy information.

Step 3 Click **OK** button.

#### 4.9.2.2 Connection type

Connection type is UDP or TCP.

Step 1 Select **Connect Type** as **UDP**, **TCP\_CLINET** or **TCP**.

Step 2 Click .

The **IP Address** interface is displayed. See Figure 4-184.



Figure 4-184

IP Address

Source IP 192 . 168 . 0 . 1 37777

Destination IP 172 . 12 . 70 . 67 Port 38800

OK Back

**Step 3** **Source IP** and **Port**. Refers to POS IP address and port.

**Step 4** Click **OK** to complete setup.

## 4.10 Operation and Maintenance

### 4.10.1 Log

You can view and search the log information, or backup log to the USB device.

**Step 1** Select **Main Menu > OPERATION > LOG**.

The **LOG** interface is displayed. See Figure 4-185.

Figure 4-185

Type All

Start Time 2000 -01 -01 00 :00 :00

End Time 2000 -01 -02 00 :00 :00 Search

64	Log Time	Event
1	2000-01-01 21:08:54	System Upgrade:Start Upgrade
2	2000-01-01 20:59:48	titles.loginFailure<admin>
3	2000-01-01 20:57:50	Change Working HDD to</dev/sdb(1)->...
4	2000-01-01 20:43:25	titles.loginFailure<admin>
5	2000-01-01 19:51:13	User logged out.<Local>
6	2000-01-01 19:34:27	User logged in.<Local>
7	2000-01-01 19:34:27	User logged in.<Local>
8	2000-01-01 19:22:27	titles.loginFailure<admin>
9	2000-01-01 17:32:41	Change Working HDD to</dev/sda(3)->...
10	2000-01-01 15:58:59	titles.loginFailure<admin>
11	2000-01-01 15:44:33	Change Working HDD to</dev/sdb(0)->...
12	2000-01-01 15:42:35	titles.loginFailure<admin>
13	2000-01-01 14:26:13	titles.loginFailure<admin>
14	2000-01-01 14:09:54	titles.loginFailure<admin>
15	2000-01-01 12:57:36	System Upgrade:Start Upgrade

1/1 Backup Details Clear

**Step 5** In the **Type** list, select the log type that you want to view (**System, Config, Storage, Record, Account, Clear, Playback, and Connection**) or select **All** to view all logs.

**Step 6** In the **Start Time** box and **End Time** box, enter the time period to search, and then click **Search**.

The search results are displayed. See Figure 4-186.

Figure 4-186

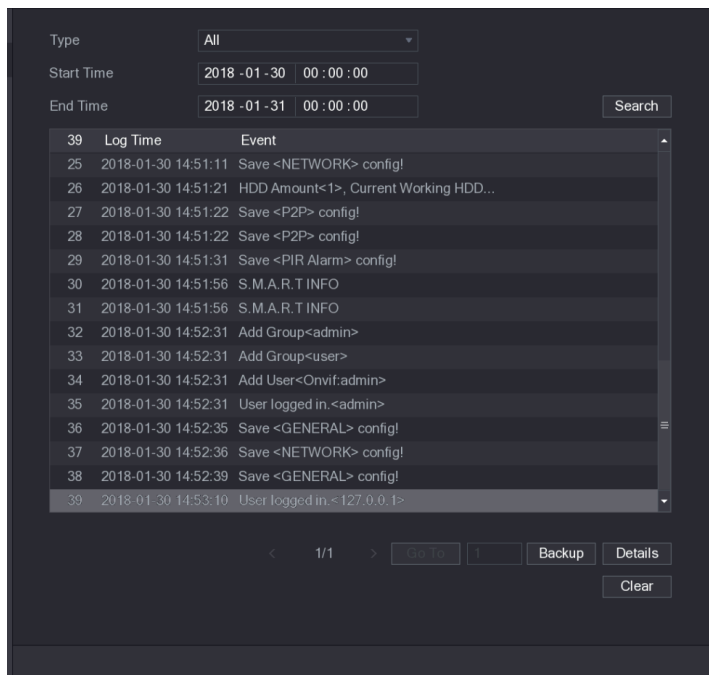

- Click **Details** or double-click the log that you want to view, the **Detailed Information** interface is displayed. Click **Next** or **Previous** to view more log information.
- Click **Backup** to back up the logs into the USB storage device.
- Click **Clear** to remove all logs.

## 4.10.2 System

### 4.10.2.1 Version

Select **Main Menu > SYSTEM > VERSION**, you can go to **VERSION** interface.

You can view NVR version information. Slight different may be found on the user interface.

### 4.10.2.2 HDD Info

You can view the HDD quantity, HDD type, total space, free space, status, and S.M.A.R.T information.

Select **Main Menu > OPERATION > INFOMATION > HDD**, the **HDD** interface is displayed. See Figure 4-187. Refer to Table 4-51 for detailed information.

Figure 4-187

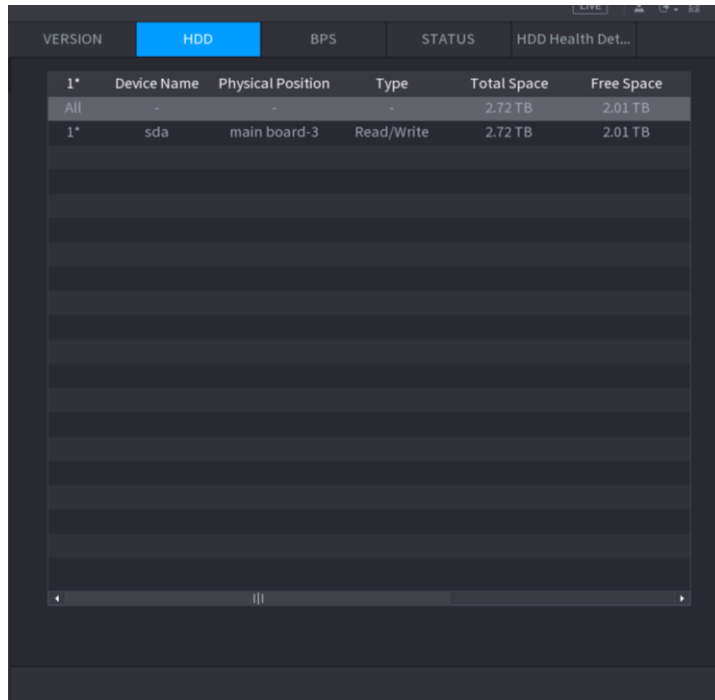

Table 4-51

Parameter	Description
No.	Indicates the number of the currently connected HDD. The asterisk (*) means the current working HDD.
Device Name	Indicates name of HDD.
Physical Position	Indicates installation position of HDD.
Type	Indicates HDD type.
Total Space	Indicates the total capacity of HDD.
Free Space	Indicates the usable capacity of HDD.
Status	Indicates the status of the HDD to show if it is working normally.
S.M.A.R.T	View the S.M.A.R.T reports from HDD detecting.

#### 4.10.2.3 BPS

Here is for you to view current video bit rate (kb/s) and resolution.

Select **Main Menu > OPERATION > INFOMATION > BPS**, the **BPS** interface is displayed. See Figure 4-188.

Figure 4-188

VERSION	HDD	BPS	STATUS	HDD Health Det...
ChannelKb/S Resolution Wave				
1	4236	352*288		
2	0			
3	2046	1920*1080		
4	7863	1920*1080		
5	0			
6	9714	0*0		
7	0	--		
8	0	--		
9	0	--		
10	0	--		
11	0	--		
12	0	--		
13	0	--		
14	0	--		
15	0	--		
16	0	--		

< 1/4 >

#### 4.10.2.4 Device Status

You can view fan running status such as speed, CPU temperature, and memory.

Select **Main Menu > OPERATION > INFORMATION > Status**, the **Status** interface is displayed. See Figure 4-189.

Figure 4-189

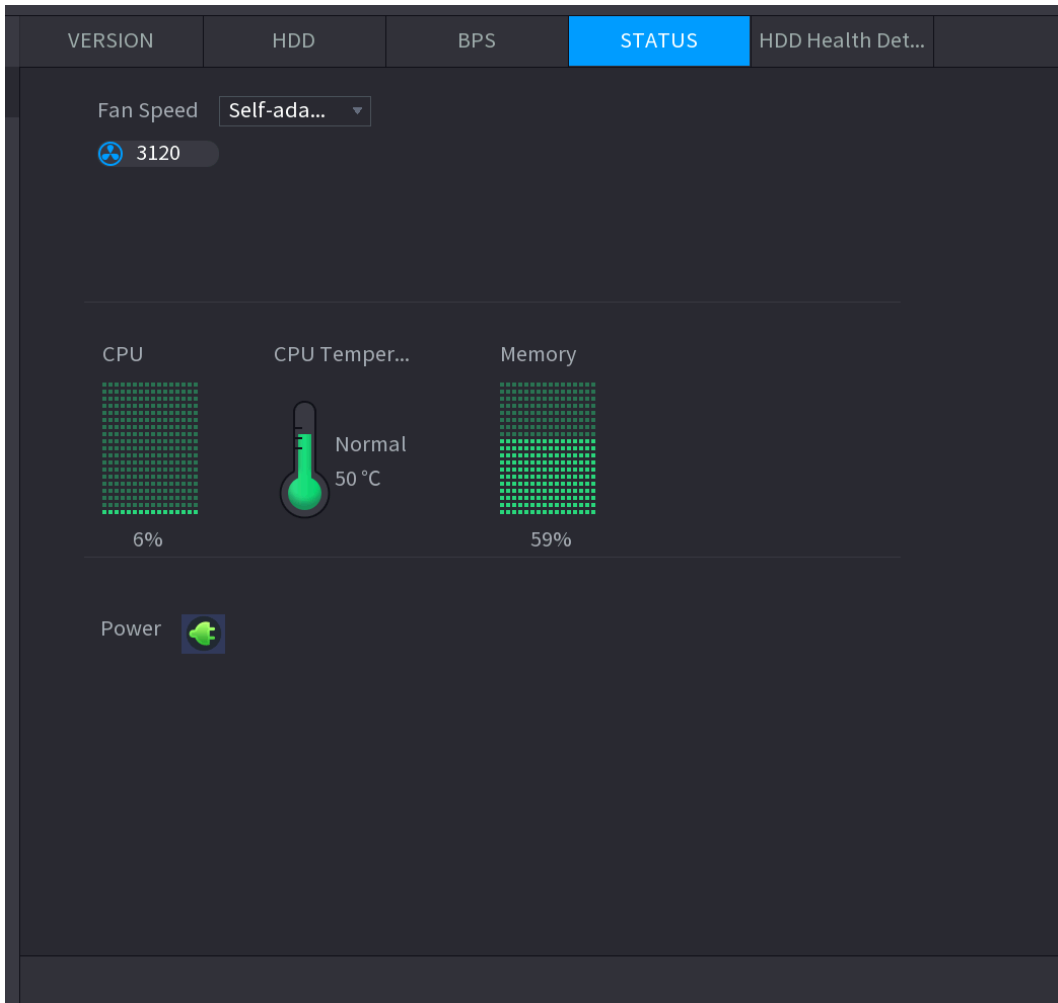

#### 4.10.2.5 HDD Health Detection

You can view HDD health status. System supports Seagate SKYHAWK series 4T and higher HDD. It displays HDD name, space, manufacturer, Serial No., and health status.

**Step 1** Select **Main Menu > OPERATION > INFOMATION > HDD Health Detection**.  
The **HDD Health Detection** interface is displayed. See Figure 4-190.

Figure 4-190

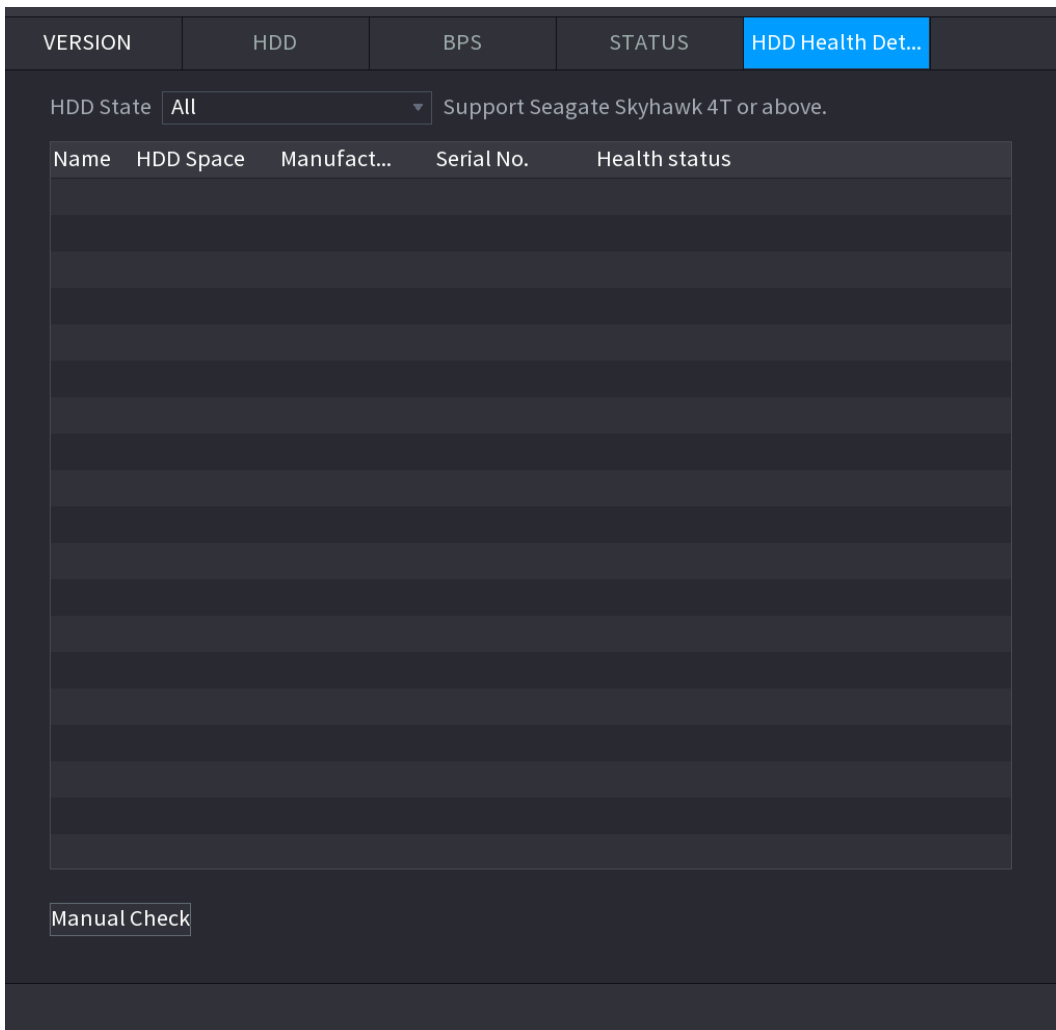

Step 2 Double-click the HDD in the list, system displays the detection report.

Step 3 Select an item in the list, system displays the corresponding report. System displays the curve report of the recent week by default.

### 4.10.3 Network

#### 4.10.3.1 Online User

You can view the online user information or block any user for a period of time. To block an online user, click  and then enter the time that you want to block this user. The maximum value you can set is 65535.

The system detects every 5 seconds to check whether there is any user added or deleted, and update the user list timely.

Select **Main Menu > OPERATION > NETWORK > ONLINE USERS**, the **Online Users** interface is displayed. See Figure 4-191.

Figure 4-191

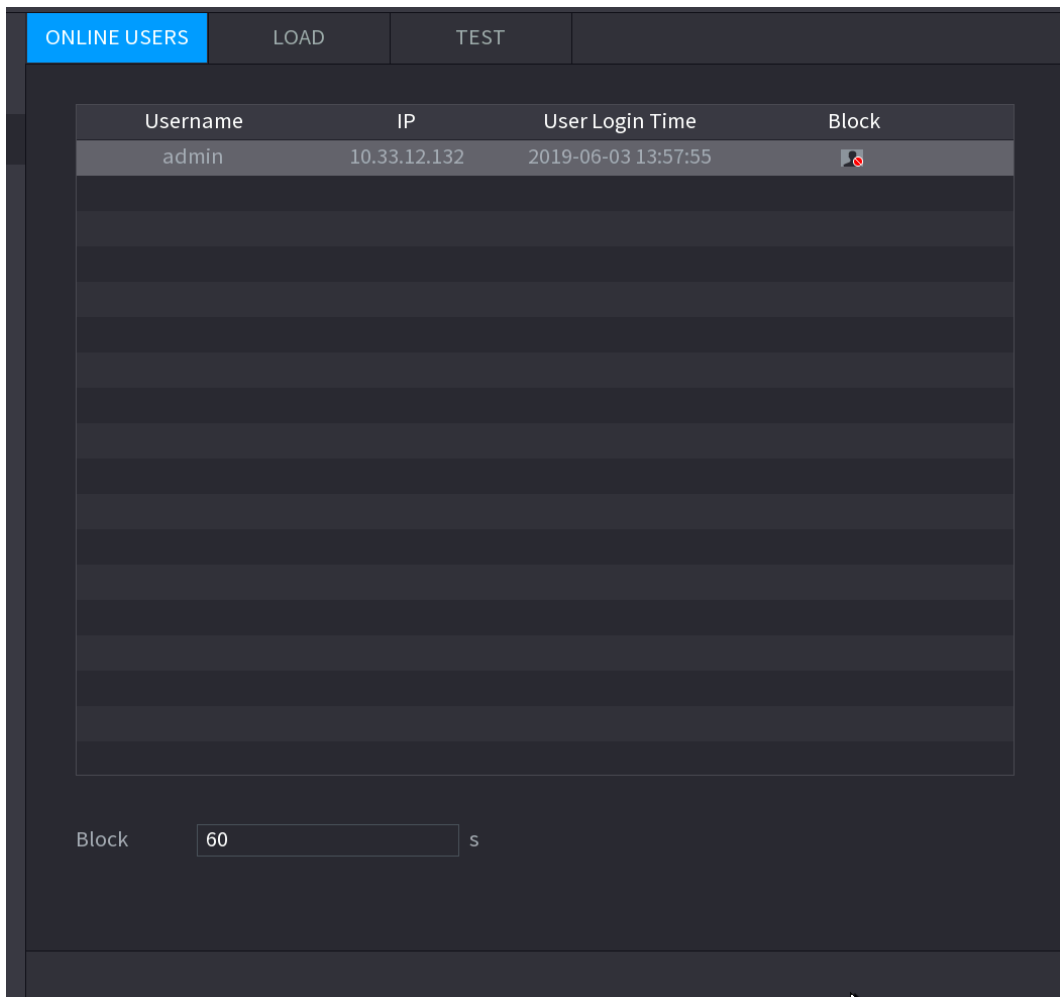

#### 4.10.3.2 Network Load

Network load means the data flow which measures the transmission capability. You can view the information such as data receiving speed and sending speed.

- Step 1 Select **Main Menu > INFO > NETWORK > LOAD**.  
The **LOAD** interface is displayed. See Figure 4-192.

Figure 4-192

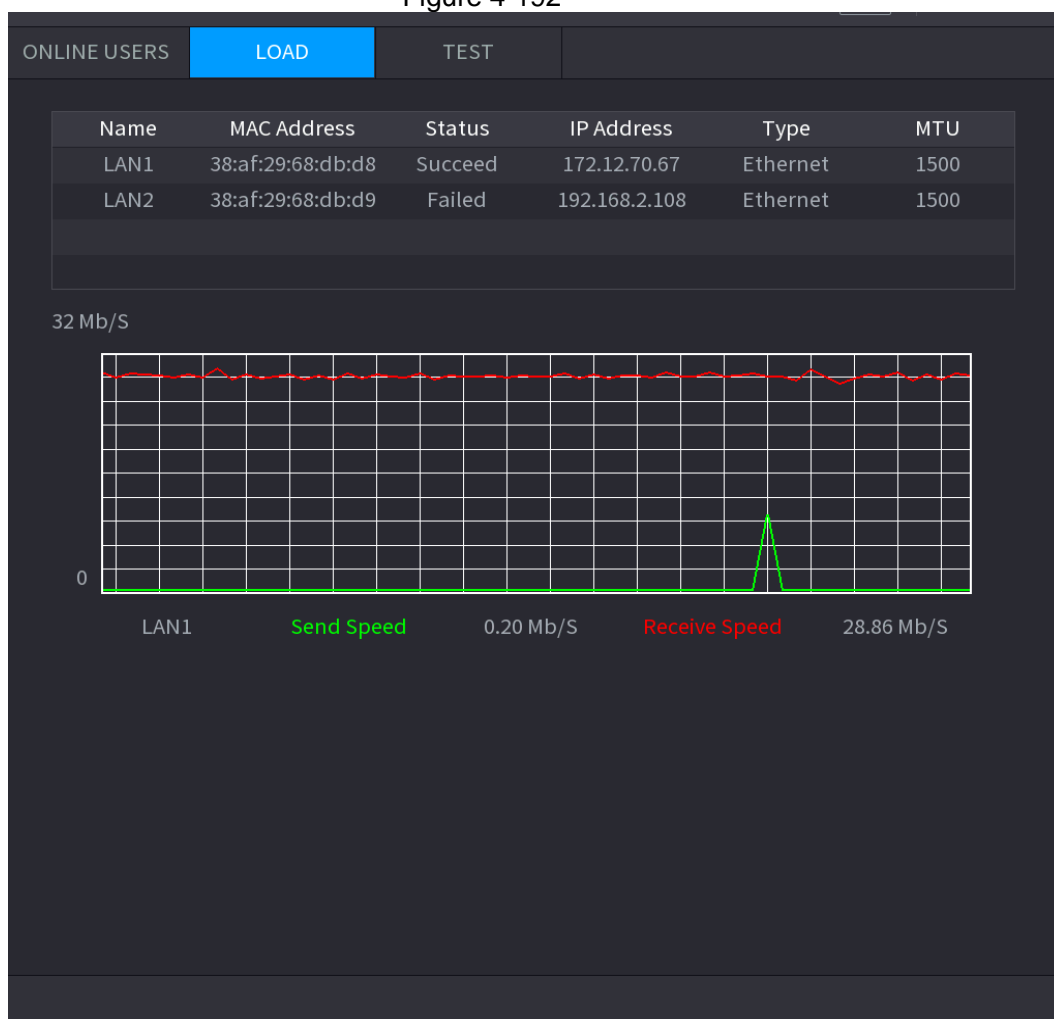

**Step 2** Click the LAN name that you want to view, for example, **LAN1**.  
The system displays the information of data sending speed and receiving speed.



- System displays LAN1 load by default.
- Only one LAN load can be displayed at one time.

#### 4.10.3.3 Network Test

You can test the network connection status between the Device and other devices.

**Step 1** Select **Main Menu > INFO > NETWORK > TEST**.  
The **TEST** interface is displayed. See Figure 4-193.



Figure 4-193

Name	IP	Sniffer Packet Size	Sniffer Packet Backup
LAN1	172.12.70.67	0KB	▶

Step 2 In the **Destination IP** box, enter the IP address.

Step 3 Click **Test**.

After testing is completed, the test result is displayed. You can check the evaluation for average delay, packet loss, and network status.

## 4.10.4 Maintenance and Management

### 4.10.4.1 Device Maintenance

When the Device has been running for a long time, you can configure the auto reboot when the Device is not working. You can also configure the case fan mode to reduce noise and extend the service life.

Step 1 Select **Main Menu > OPERATION > SYSTEM MAINTAIN > AUTO MAINTAIN**.

The **AUTO MAINTAIN** interface is displayed. See Figure 4-194.

Figure 4-194

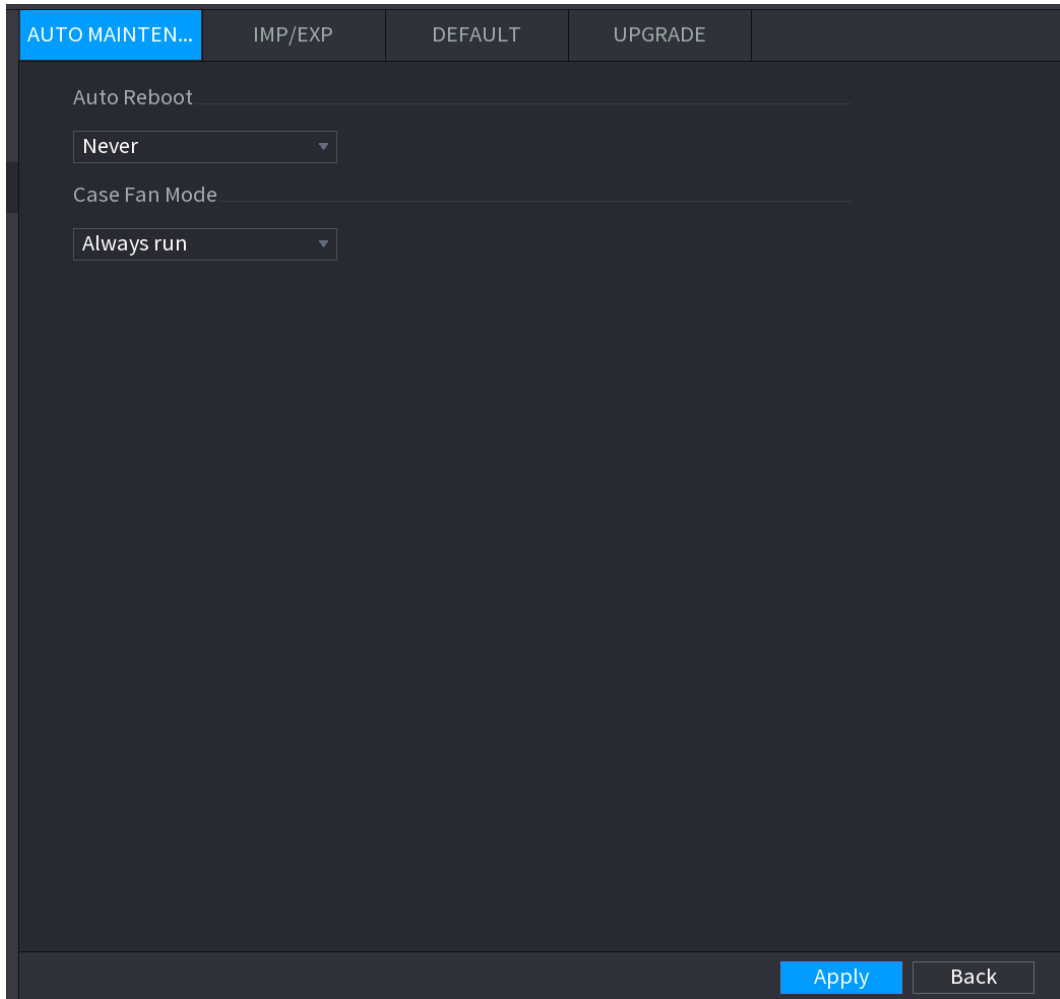

**Step 2** Configure the settings for the system maintenance parameters. See Table 4-52.  
Table 4-52

Parameter	Description
Auto Reboot	In the <b>Auto Reboot</b> list, select the reboot time.
Case Fan Mode	In the <b>Case Fan Mode</b> list, you can select <b>Always run</b> or <b>Auto</b> . If you select <b>Auto</b> , the case fan will stop or start according to the external conditions such as the Device temperature.  This function is for some series products only. , and it is only supported on the local configuration interface.

**Step 3** Click **Apply** to complete the settings.

#### 4.10.4.2 IMP/EXP

You can export or import the Device system settings if there are several Devices that require the same setup.



- The **IMP/EXP** interface cannot be opened if the backup operation is ongoing on the other interfaces.
- When you open the **IMP/EXP** interface, the system refreshes the devices and sets the current directory as the first root directory.
- Click **Format** to format the USB storage device.

### Exporting System Settings

**Step 1** Select **Main Menu > OPERATION > SYSTEM MAINTAIN > IMP/EXP**.  
The **IMP/EXP** interface is displayed. See Figure 4-195.

Figure 4-195

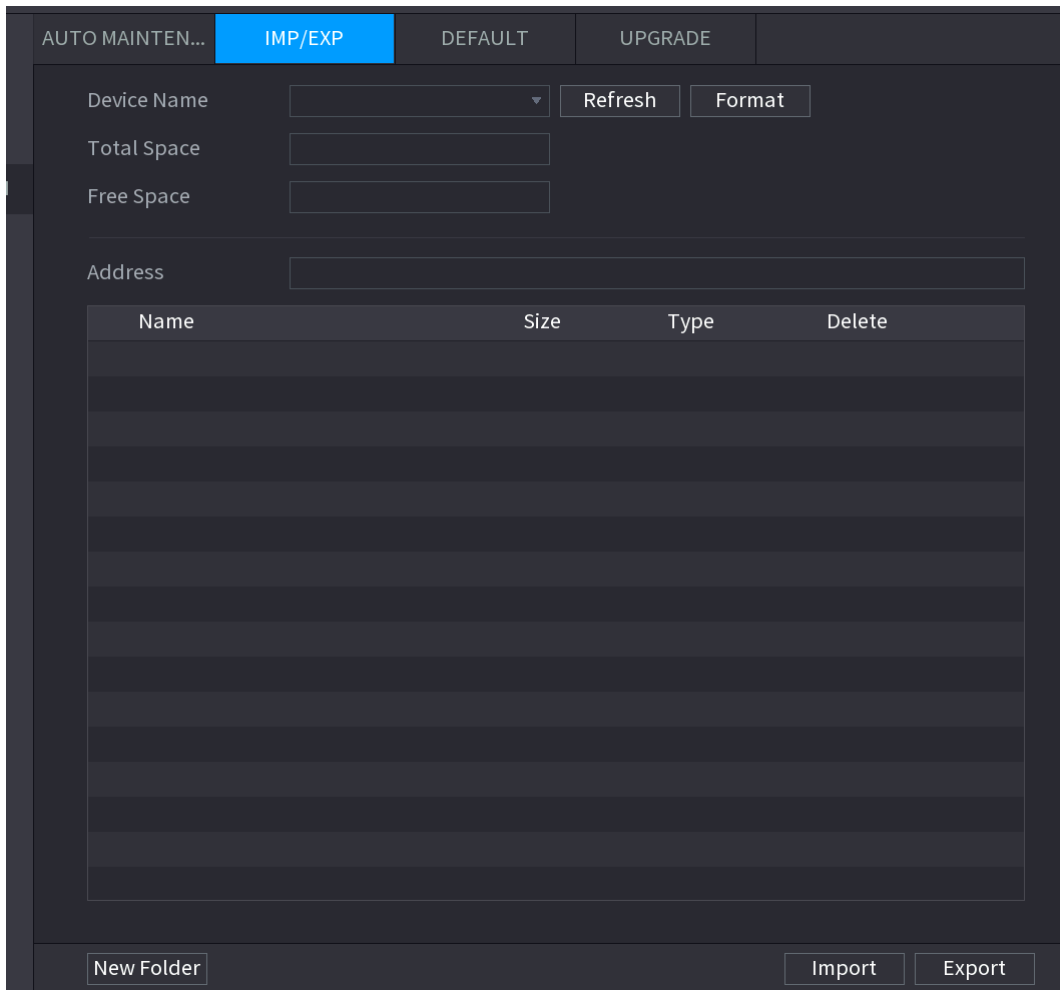

Step 2 Insert a USB storage device into one of the USB ports on the Device.

Step 3 Click **Refresh** to refresh the interface.

The connected USB storage device is displayed. See Figure 4-196.

Figure 4-196

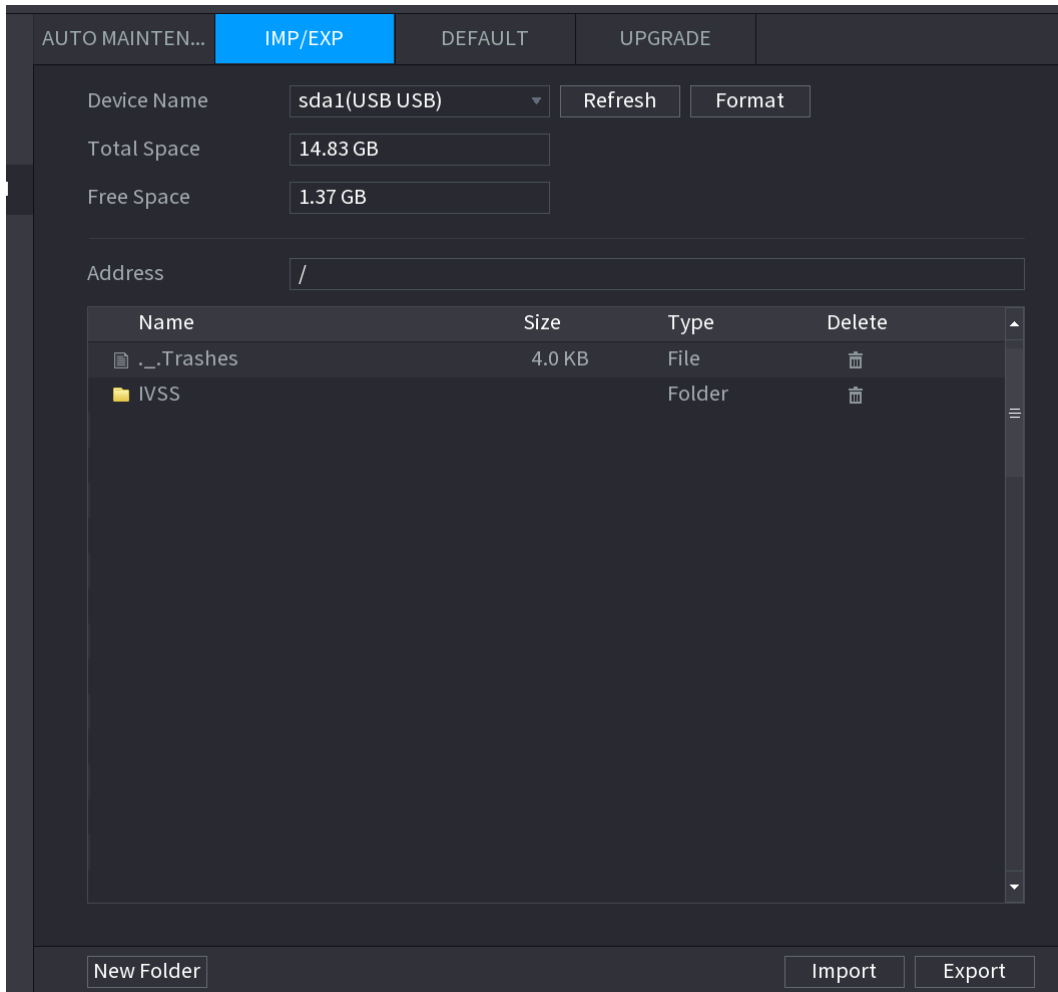

**Step 4** Click **Export**.

There is a folder under the name style of "Config\_[YYYYMMDDhhmmss]". Double-click this folder to view the backup files.

#### 4.10.4.3 Default



This function is for admin account only.

You can select the settings that you want to restore to the factory default.

**Step 1** Select **Main Menu > OPERATION > SYSTEM MAINTAIN > DEFAULT**.

The **DEFAULT** interface is displayed. See Figure 4-197.

Figure 4-197

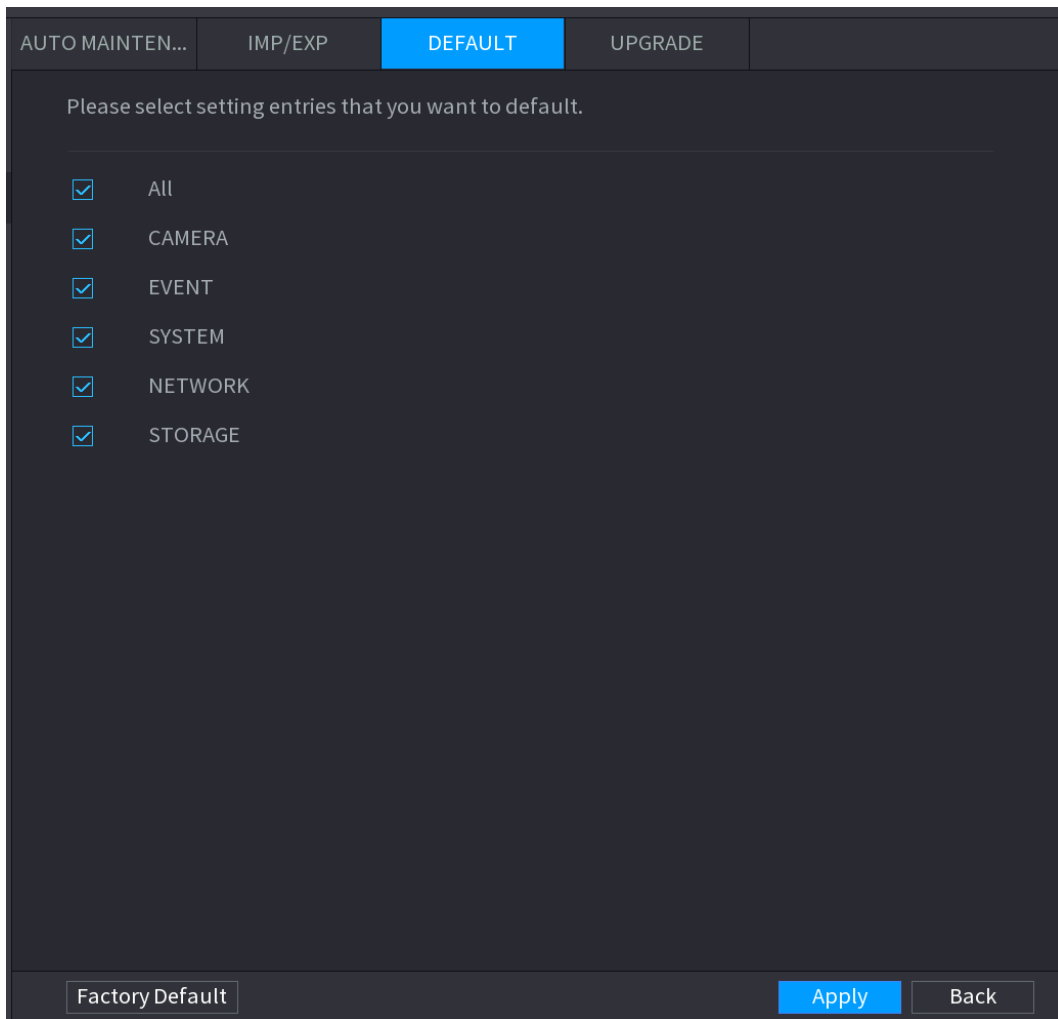

Step 2 Restore the settings.

- Select the settings that you want to restore, and then click **Apply**. The system starts restoring the selected settings.
- Click **Factory Default**, and then click **OK**. The system starts restoring the whole settings.

4.10.4.4 System Update

4.10.4.4.1 Upgrading File

Step 1 Insert a USB storage device containing the upgrade files into the USB port of the Device.

Step 2 Select **Main Menu > OPERATION > SYSTEM MAINTAIN > UPGRADE**.

The **UPGRADE** interface is displayed. See Figure 4-198.

Figure 4-198

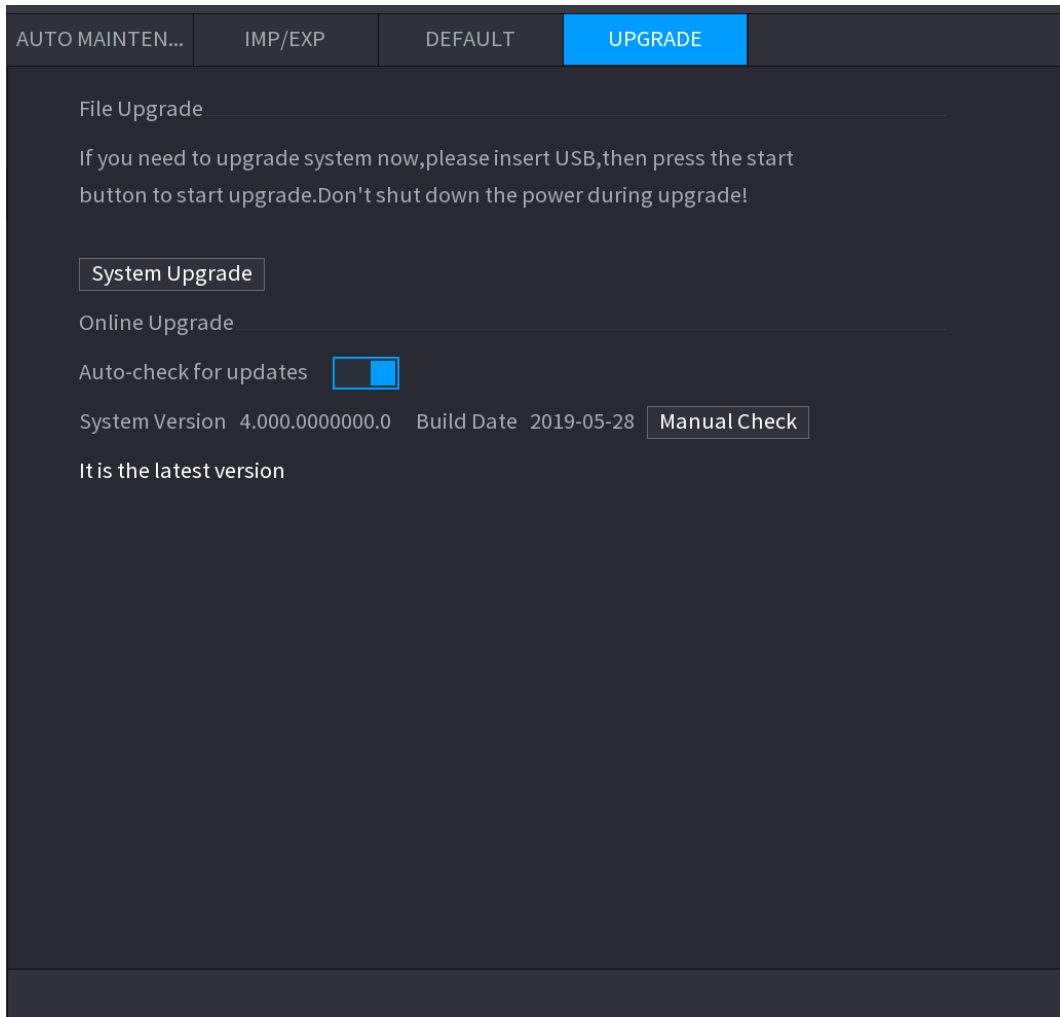

- Step 3** Click **System Upgrade**.  
The **System Upgrade** interface is displayed. See Figure 4-199.

Figure 4-199

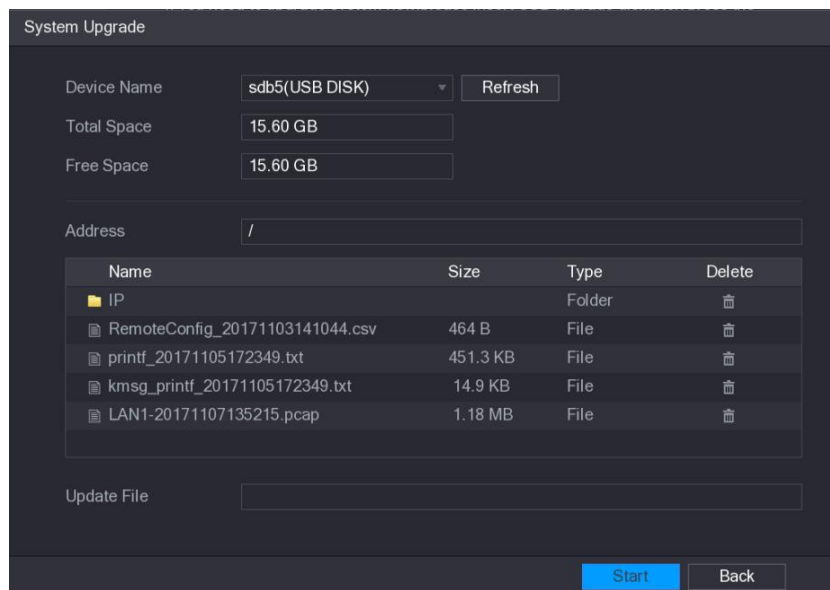

- Step 4** Click the file that you want to upgrade.  
The selected file is displayed in the **Update File** box.
- Step 5** Click **Start**.

#### 4.10.4.4.2 Online Upgrade

When the Device is connected to Internet, you can use online upgrade function to upgrade the system.

Before using this function, you need to check whether there is any new version by auto check or manual check.

- Auto check: The Device checks if there is any new version available at intervals.
- Manual check: Perform real-time check whether there is any new version available.



Ensure the correct power supply and network connection during upgrading; otherwise the upgrading might be failed.

**Step 1** Select **Main Menu >> OPERATION > SYSTEM MAINTAIN > UPGRADE**.

The **UPGRADE** interface is displayed. See Figure 4-200.

Figure 4-200

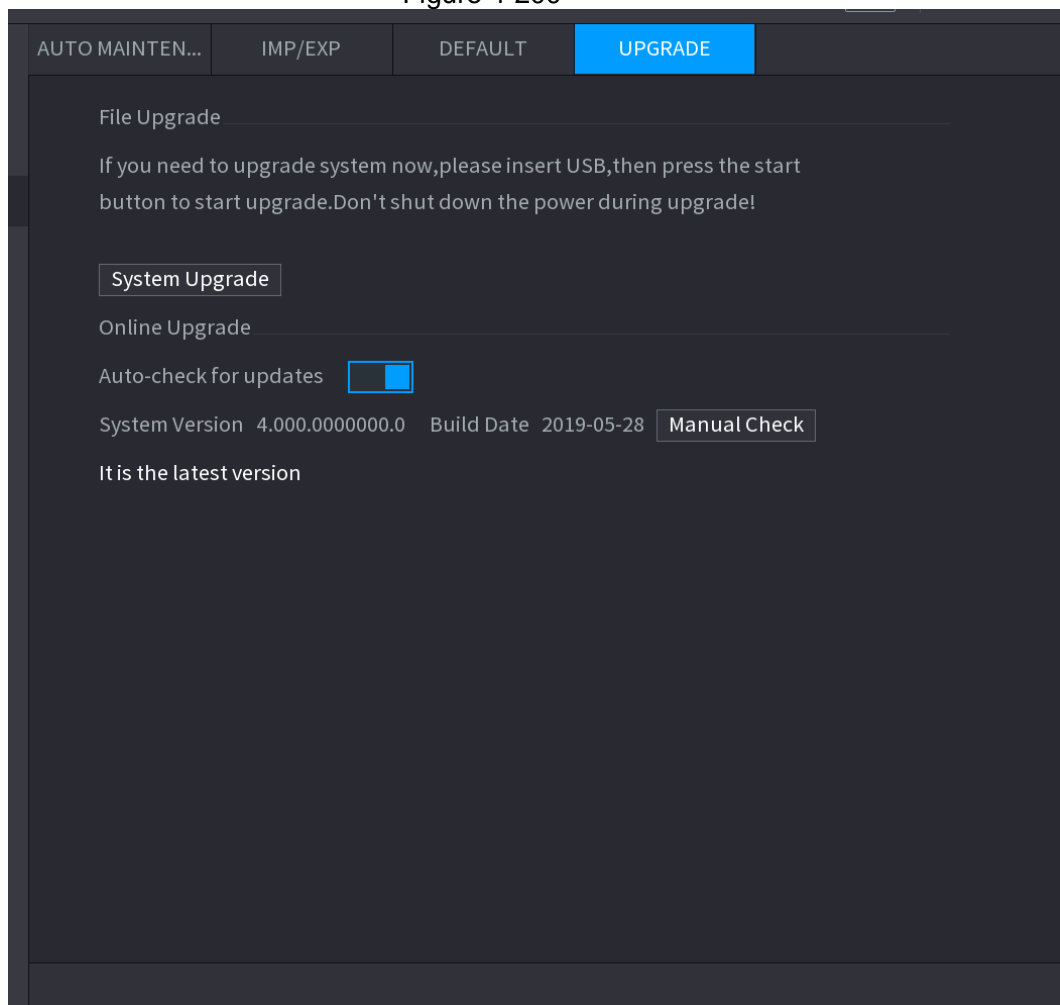

**Step 2** Check whether there is any new version available.

- Auto-check for updates: Enable Auto-check for updates.
- Manual check: Click Manual Check.

The system starts checking the new versions. After checking is completed, the check result is displayed.

- If the "It is the latest version" text is displayed, you do not need to upgrade.
- If the text indicating there is a new version, go to the step 3. .

**Step 3** Click **Upgrade now** to update the system.

#### 4.10.4.4.3 Uboot Upgrading



- Under the root directory in the USB storage device, there must be "u-boot.bin.img" file and "update.img" file saved, and the USB storage device must be in FAT32 format.

- Make sure the USB storage device is inserted; otherwise the upgrading cannot be performed.

When starting the Device, the system automatically check whether there is a USB storage device connected and if there is any upgrade file, and if yes and the check result of the upgrade file is correct, the system will upgrade automatically. The Uboot upgrade can avoid the situation that you have to upgrade through +TFTP when the Device is halted.

## 4.11 File Backup

You can back up the record file to the UBS device.

**Step 1** Connect USB burner, USB device or portable HDD to the device.

**Step 2** Select **Main menu > BACKUP**, the **Backup** interface is displayed. See Figure 4-201.

Figure 4-201

The screenshot shows a backup configuration interface. At the top, 'Device Name' is set to 'sda1(USB USB)' and 'Format' shows '1.37 GB/14.83 GB(Free/Total)'. Below this, there are fields for 'Path' (with a 'Browse' button), 'Record C...' (set to 'D1'), 'Type' (set to 'All'), and 'Main Stream'. 'Start Time' and 'End Time' are both set to '2000 -01 -01 00 :00 :00'. 'File Format' is set to 'DAV'. There are 'Search' and 'Clear' buttons. Below the form is a table with columns: '0', 'Channel Type', 'Start Time', 'End Time', 'Size(KB)', and 'Play'. The table is currently empty. At the bottom left, it says '0.00 KB(Space Needed)'. At the bottom right, there are 'Onekey Backup' and 'Backup' buttons.

**Step 3** Select backup device and then set channel, file start time and end time.

**Step 4** Click **Search** button, system begins search. All matched files are listed below. System automatically calculates the capacity needed and remained.

**Step 5** System only backup files with a ✓ before channel name. You can use Fn or cancel button to delete ✓ after file serial number.

**Step 6** Click backup button, you can backup selected files. There is a process bar for you reference.

**Step 7** When the system completes backup, you can see a dialogue box prompting successful backup.

**Step 8** Click **Backup** button, system begins burning. At the same time, the **Backup** button becomes **Stop** button. You can view the remaining time and process bar at the left bottom.



- During backup process, you can click **ESC** to exit current interface for other operation (For some series product only). The system will not terminate backup process. (This function is for some series products only.)
- System pops up corresponding dialogue box if there is no backup device, or no backup file, or error occurs during backup process.
- The file name format usually is: Channel number+Record type+Time. In the file name, the YDM format is Y+M+D+H+M+S. File extension name is .dav.



- Click **Onekey Backup** to back up all required files.

## 4.12 Network

You can set NVR network parameters so that the NVR can communicate with devices in the same LAN.

### 4.12.1 TCP/IP

Select **Main Menu > NETWORK > TCP/IP**, the **TCP/IP** interface is displayed. See Figure 4-202.

Figure 4-202

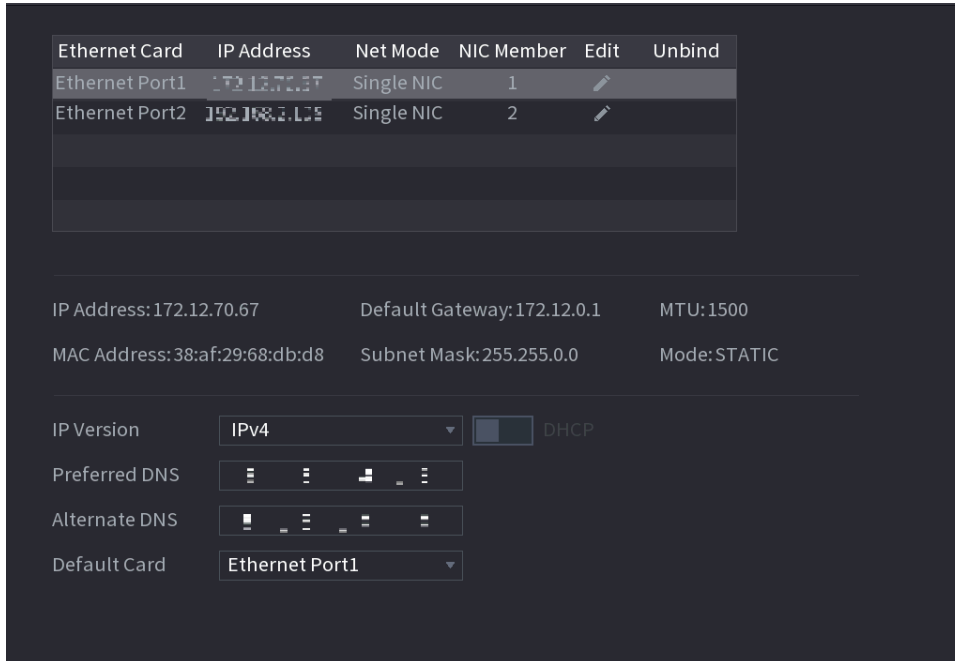



Table 4-53

Parameter	Description
Net Mode	<ul style="list-style-type: none"> <li>● <b>Multi-address:</b> Two Ethernet ports work separately through either of which you can request the Device to provide the services such as HTTP and RTSP. You need to configure a default Ethernet port (usually the Ethernet port 1 by default) to request the services from the device end such as DHCP, Email and FTP. If one of the two Ethernet ports is disconnected as detected by networking testing, the system network status is regarded as offline.</li> <li>● <b>Fault Tolerance:</b> Two Ethernet ports share one IP address. Normally only one Ethernet port is working and when this port fails, the other port will start working automatically to ensure the network connection.</li> <li>● When testing the network status, the network is regarded as offline only when both of the two Ethernet ports are disconnected. The two Ethernet ports are used under the same LAN.</li> <li>● <b>Load Balance:</b> Two network cards share one IP address and they are working at the same time to share the network load averagely. If one of them fails, the other can continue working normally.</li> <li>● When testing the network status, the network is regarded as offline only when both of the two Ethernet ports are disconnected. The two Ethernet ports are used under the same LAN.</li> </ul> <p> The Device with single Ethernet port does not support this function.</p>
Default Ethernet Port	In the <b>Ethernet Card</b> list, select an Ethernet port as a default port. This setting is available only when the <b>Multi-address</b> is selected in the <b>Net Mode</b> list.

Parameter	Description
IP Version	In the <b>IP Version</b> list, you can select <b>IPv4</b> or <b>IPv6</b> . Both versions are supported for access.
MAC Address	Displays the MAC address of the Device.
DHCP	Enable the DHCP function. The IP address, subnet mask and default gateway are not available for configuration once DHCP is enabled. <ul style="list-style-type: none"> <li>• If DHCP is effective, the obtained information will display in the <b>IP Address</b> box, <b>Subnet Mask</b> box and <b>Default Gateway</b> box. If not, all values show 0.0.0.0.</li> <li>• If you want manually configure the IP information, disable the DHCP function first.</li> <li>• If PPPoE connection is successful, the IP address, subnet mask, default gateway, and DHCP are not available for configuration.</li> </ul>
IP Address	Enter the IP address and configure the corresponding subnet mask and default gateway. 
Subnet Mask	
Default Gateway	
DNS DHCP	Enable the DHCP function to get the DNS address from router.
Preferred DNS	In the <b>Preferred DNS</b> box, enter the IP address of DNS.
Alternate DNS	In the <b>Alternate DNS</b> box, enter the IP address of alternate DNS.
MTU	In the <b>MTU</b> box, enter a value for network card. The value ranges from 1280 byte through 1500 byte. The default is 1500. The suggested MTU values are as below. <ul style="list-style-type: none"> <li>• 1500: The biggest value of Ethernet information package. This value is typically selected if there is no PPPoE or VPN connection, and it is also the default value of some routers, network adapters and switches.</li> <li>• 1492: Optimized value for PPPoE.</li> <li>• 1468: Optimized value for DHCP.</li> <li>• 1450: Optimized value for VPN.</li> </ul>
Test	Click <b>Test</b> to test if the entered IP address and gateway are interworking.

#### 4.12.2 Port

You can configure the maximum connection accessing the Device from Client such as WEB, Platform, and Mobile Phone and configure each port settings.

Step 1 Select **Main Menu > NETWORK > PORT**.

The **PORT** interface is displayed. See Figure 4-203.

Figure 4-203

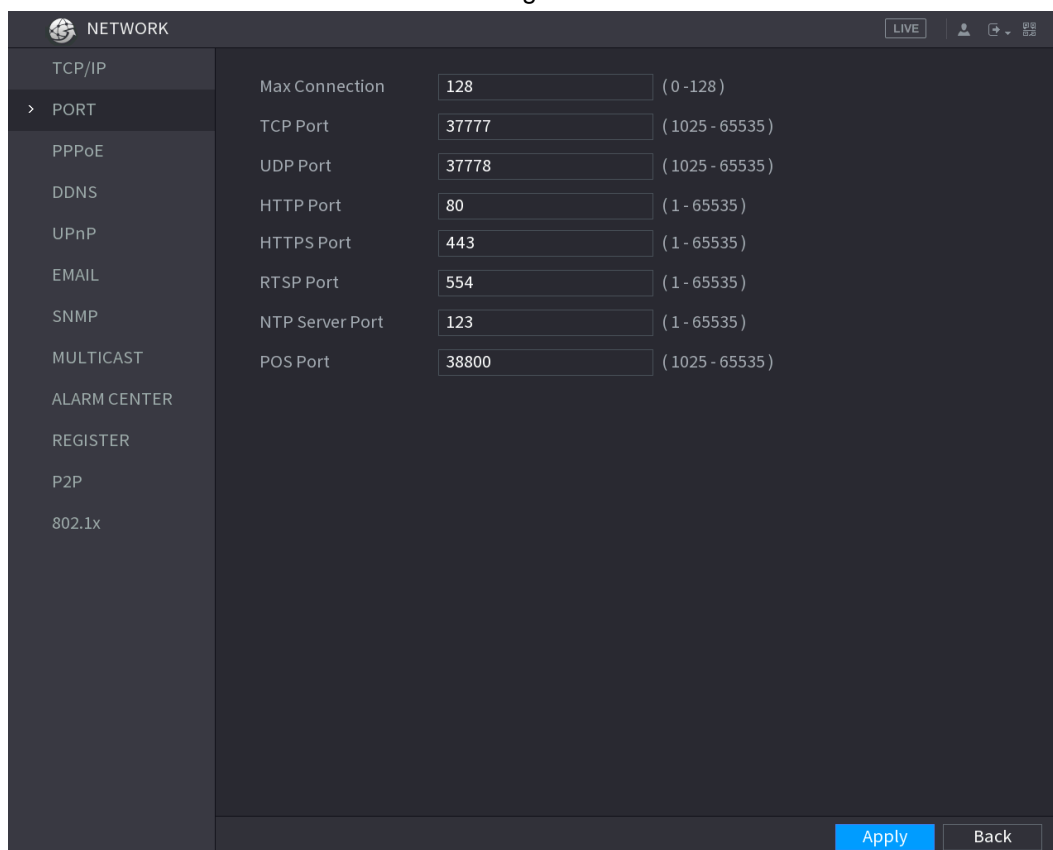

**Step 2** Configure the settings for the connection parameters. See Table 4-54.



The connection parameters except Max Connection cannot take effects until the Device has been restarted.

Table 4-54

Parameter	Description
Max Connection	The allowable maximum clients accessing the Device at the same time, such as WEB, Platform, and Mobile Phone. Select a value between 1 and 128. The default value setting is 128.
TCP Port	The default value setting is 37777. You can enter the value according to your actual situation.
UDP Port	The default value setting is 37778. You can enter the value according to your actual situation.
HTTP Port	The default value setting is 80. You can enter the value according to your actual situation. If you enter other value, for example, 70, and then you should enter 70 after the IP address when logging in the Device by browser.
RTSP Port	The default value setting is 554. You can enter the value according to your actual situation.
POS Port	Data transmission. The value range is from 1 through 65535. The default value is 38800.
HTTPS Enable	Enable <b>HTTPS</b> .
HTTPS Port	HTTPS communication port. The default value setting is 443. You can enter the value according to your actual situation.

**Step 3** Click **Apply** to complete the settings.

### 4.12.3 Wi-Fi AP

You can configure Wi-Fi parameters for the NVR to ensure that a wireless IPC can connect to the NVR through Wi-Fi AP.

### Prerequisites

This function requires the built-in Wi-Fi module in the device, and actual product shall prevail.

#### 4.12.3.1 General Settings

You can configure SSID, encryption type, password and channel of the device.



- This function is supported on select wireless models.
- When the wireless IPC and NVR are matched, the pairing will be completed in 120 seconds after they are powered-on.

**Step3** Select **Main Menu > NETWORK > Wi-Fi AP > General**.

The **General** interface is displayed. See Figure 4-204.

Figure 4-204

The screenshot shows the 'General' settings page for a Wi-Fi AP. The 'General' tab is selected, and the 'Advanced' tab is also visible. The settings are as follows:

Parameter	Value
Wi-Fi	<input checked="" type="checkbox"/>
SSID	DAP-H6TG4...
Hide SSID	<input type="checkbox"/>
Encryption Type	WPA2 PSK
Password	7954170d19...
Select Channel	6
Network Proxy	<input type="checkbox"/>

At the bottom of the interface, there are three buttons: 'Default', 'Apply', and 'Cancel'.

**Step4** Select **Wi-Fi** to enable Wi-Fi.

**Step5** Configure parameters. For details, see Table 4-55.

Table 4-55

Parameter	Description
SSID	Wi-Fi name for the device.
Hide SSID	You can hide the Wi-Fi name when select this option.
Encryption Type	Select an encryption mode. The device provides WPA2 PSK and WPA PSK.
Password	Set the Wi-Fi password for the device.
Select Channel	Select the channel for device communication.
Network Proxy	Enables the external network access through the device for a wireless IPC.

#### 4.12.3.2 Advanced Settings



This function is supported on select wireless models.

You can configure IP address, subnet mask, default gateway, DHCP server of the device.

**Step1** Select **Main Menu > NETWORK > Wi-Fi AP > Advanced**.

The **Advanced** interface is displayed. See Figure 4-205.

Figure 4-205

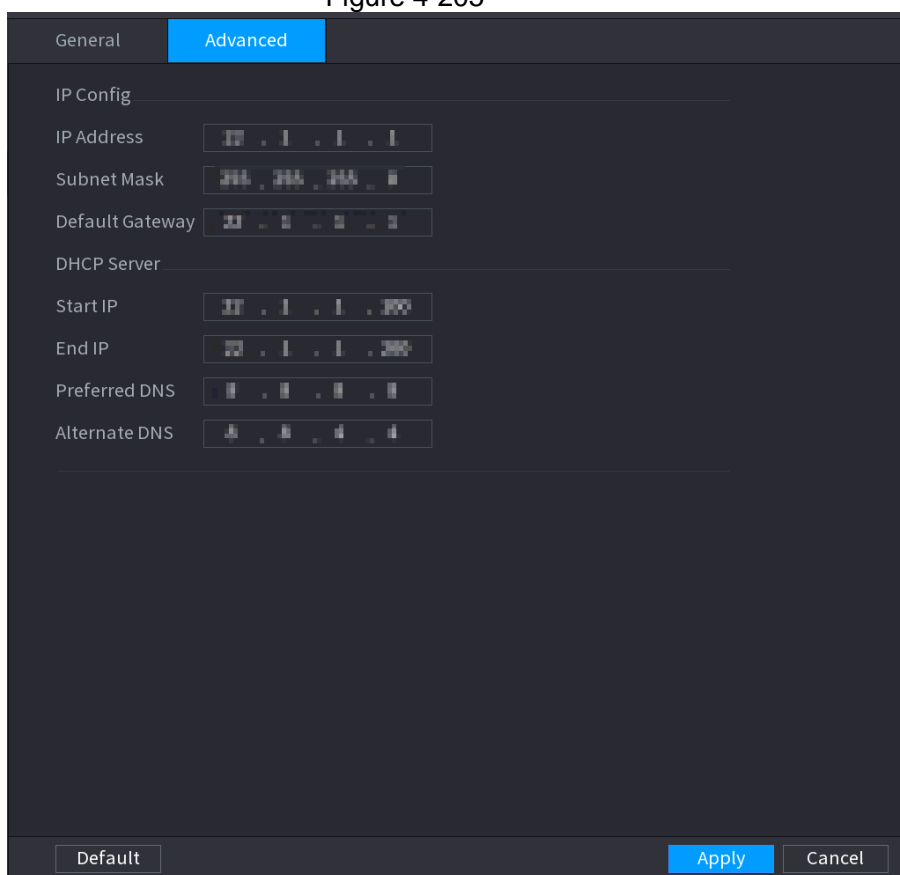

**Step2** Configure parameters. For details, see Table 4-56.

Table 4-56

Parameter	Description
IP Address	Set IP address, subnet mask and default gateway for the Wi-Fi parameters of NVR.
Subnet Mask	
Default Gateway	
Start IP	Set the start IP address and end IP address of the DHCP server.
End IP	
Preferred DNS	Set preferred/alternate DNS server of the DHCP server.
Alternate DNS	

**Step3** Click **Apply** to complete the configuration.

#### 4.12.4 Repeater

The device supports relay settings for the wireless relay IPC to extend video transmission distance and range.



This function is supported on select models.

#### Prerequisites

- The device has the built-in Wi-Fi module.
- The IPC has wireless relay module.

#### Procedure

**Step 1** Power on the NVR and wireless replayIPC, and connect all IPCs to the NVR through Wi-Fi.

**Step 2** Select **Main Menu > NETWORK > REPEATER**.  
The **REPEATER** interface is displayed. See Figure 4-206.



- Green connection line represents the successful connection between channel and wireless IPC.
- Auto cascade: After selecting auto cascade, the IPC can cascade to NVR automatically.

Figure 4-206

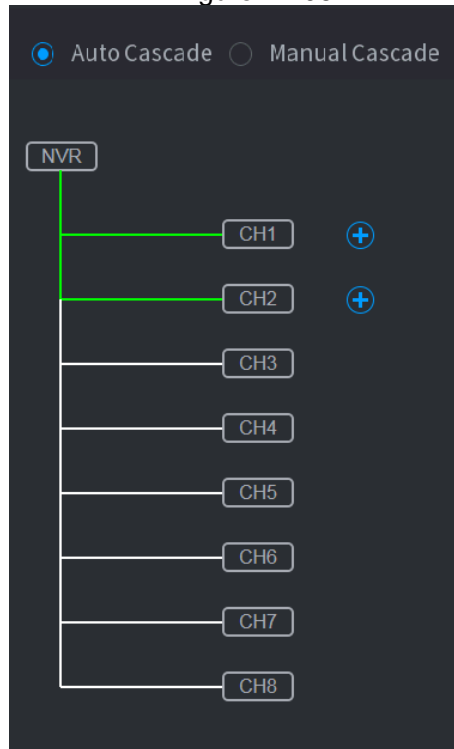

**Step 3** Select **Manual Cascade**.

The **Manual Cascade** interface is displayed. See Figure 4-207.



Manual cascade: You can use manual cascade when there are 2 IPCs in the network at least.

Figure 4-207

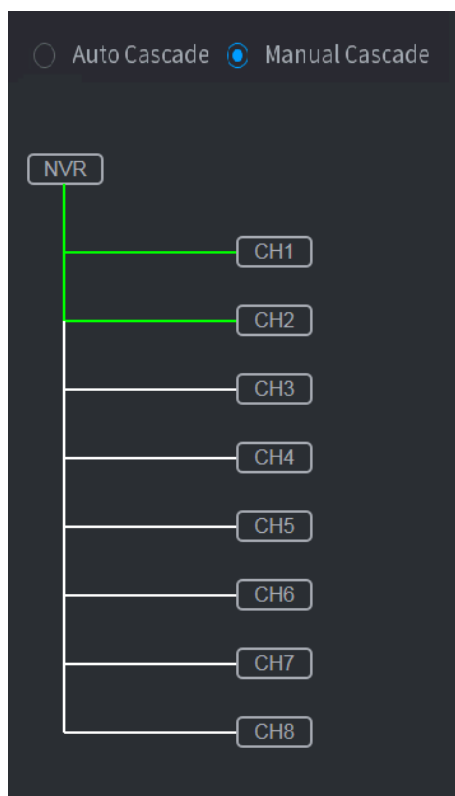

**Step 4** Click  and select the channel to be added.  
The following interface is displayed after successful adding. See Figure 4-208.

Figure 4-208



**Step 5** Click **Apply** to complete the configuration.

#### 4.12.5 PPPoE

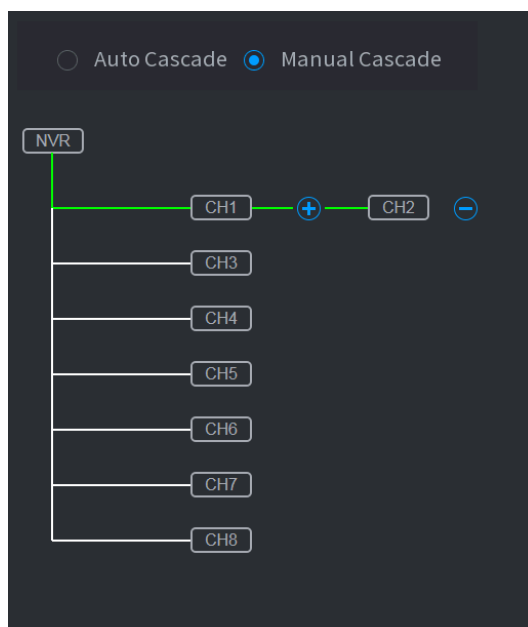
PPPoE is another way for the Device to access the network. You can establish network connection by configuring PPPoE settings to give the Device a dynamic IP address in the WAN. To use this function, firstly you need to obtain the user name and password from the Internet Service Provider.

**Step 1** Select **Main Menu > NETWORK > PPPoE**.

The **PPPoE** interface is displayed. See Figure 4-209.  
Figure 4-209

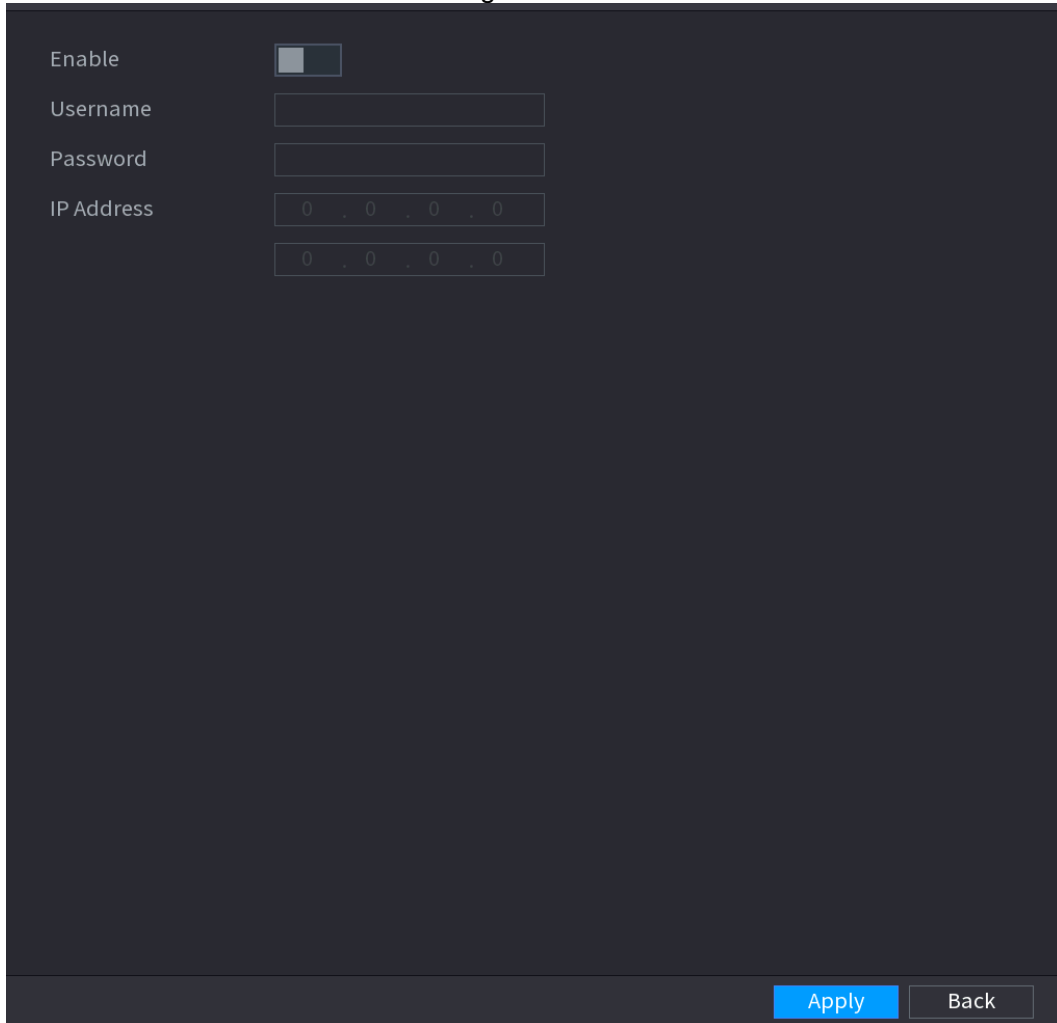

**Step 2** Enable the PPPoE function.

**Step 3** In the **User Name** box and **Password** box, enter the user name and password accordingly provided by the Internet Service Provider.

**Step 4** Click **Apply** to complete the settings.

The system pops up a message to indicate the successfully saved. The IP address appears on the PPPoE interface. You can use this IP address to access the Device.



When the PPPoE function is enabled, the IP address on the **TCP/IP** interface cannot be modified.

#### 4.12.6 DDNS

When the IP address of the Device changes frequently, the DDNS function can dynamically refresh the correspondence between the domain on DNS and the IP address, ensuring you access the Device by using the domain.

#### Preparations

Ensure the Device supports the DDNS Type and log in the website provided by the DDNS service provider to register the information such as domain from PC located in the WAN.



After you have registered and logged in the DDNS website successfully, you can view the information of all the connected devices under this user name.

**Step 1** Select **Main Menu > NETWORK > DDNS**.

The **DDNS** interface is displayed. See Figure 4-210.



Figure 4-210

Enable

After enabling DDNS function, third-party server may collect your device info.

DDNS Type: NO-IP DDNS

Host IP: dynupdate.no-ip.com

Domain Name:

Username:

Password:

Interval: 1440 Min.

Test Apply Back

**Step 2** Configure the settings for the DDNS parameters. See Table 4-57.

Table 4-57

Parameter	Description
Enable	Enable the DDNS function. After enabling DDNS function, the third-party might collect your Device information.
DDNS Type	Type and address of DDNS service provider.
Host IP	<ul style="list-style-type: none"> <li>Type: DynDNS DDNS; address: members.dyndns.org</li> <li>Type: NO-IP DDNS; address: dynupdate.no-ip.com</li> <li>Type: CN99 DDNS; address: members.3322.org</li> </ul>
Domain Name	The domain name for registering on the website of DDNS service provider.
User Name	Enter the user name and password obtained from DDNS service provider. You need to register (including user name and password) on the website of DDNS service provider.
Password	
Interval	Enter the amount of time that you want to update the DDNS.

**Step 3** Click **Apply** to complete the settings.

Enter the domain name in the browser on your PC, and then press **Enter**.

If the web interface of the Device is displayed, the configuration is successful. If not, the configuration is failed.

#### 4.12.7 UPnP

You can map the relationship between the LAN and the WAN to access the Device on the LAN through the IP address on the WAN.

#### Preparations

Login the router to set the WAN port to enable the IP address to connect into the WAN.

Enable the UPnP function at the router.

Connect the Device with the LAN port on the router to connect into the LAN.

Select **Main Menu > NETWORK > TCP/IP**, configure the IP address into the router IP address range, or enable the DHCP function to obtain an IP address automatically.

## Configuration Steps

- Step 1** Select **Main Menu > NETWORK > UPnP**.  
The **UPnP** interface is displayed. See Figure 4-211.

Figure 4-211

The screenshot shows the UPnP configuration interface. At the top, there is a toggle for PAT (currently off) and a status field showing 'Offline'. Below these are input fields for LAN IP and WAN IP, both set to '0 . 0 . 0 . 0'. A section titled 'PAT Table' contains a table with 7 rows of service configurations. At the bottom right, there are 'Apply' and 'Back' buttons.





7	Service Name	Protocol	Int.Port	Ext.Port	Edit
1	HTTP	TCP	80	80	
2	TCP	TCP	37777	37777	
3	UDP	UDP	37778	37778	
4	RTSP	UDP	554	554	
5	RTSP	TCP	554	554	
6	SNMP	UDP	161	161	
7	HTTPS	TCP	443	443	

Figure 4-212

The screenshot shows a 'PORT INFO' dialog box with four input fields: 'Service Name' (HTTP), 'Protocol' (TCP), 'Int.Port' (80), and 'Ext.Port' (80). At the bottom, there are 'OK' and 'Cancel' buttons.

- Step 2** Configure the settings for the UPnP parameters. See Table 4-58.

Table 4-58

Parameter	Description
PAT	Enable the UPnP function.
Status	Indicates the status of UPnP function. <ul style="list-style-type: none"> <li>● Offline: Failed.</li> <li>● Online: Succeeded.</li> </ul>
LAN IP	Enter IP address of router on the LAN.  After mapping succeeded, the system obtains IP address automatically without performing any configurations.
WAN IP	Enter IP address of router on the WAN.  After mapping succeeded, the system obtains IP address automatically without performing any configurations.
PAT Table	The settings in PAT table correspond to the UPnP PAT table on the router. <ul style="list-style-type: none"> <li>● Service Name: Name of network server.</li> <li>● Protocol: Type of protocol.</li> <li>● Int. Port: Internal port that is mapped on the Device.</li> <li>● Ext. Port: External port that is mapped on the router.</li> </ul>  <ul style="list-style-type: none"> <li>● To avoid the conflict, when setting the external port, try to use the ports from 1024 through 5000 and avoid popular ports from 1 through 255 and system ports from 256 through 1023.</li> <li>● When there are several devices in the LAN, properly arrange the ports mapping to avoid mapping to the same external port.</li> <li>● When establishing a mapping relationship, ensure the mapping ports are not occupied or limited.</li> <li>● The internal and external ports of TCP and UDP must be the same and cannot be modified.</li> </ul>  Click to modify the external port.

**Step 3** Click **Apply** to complete the settings.

In the browser, enter <http://WAN IP: External IP port>. You can visit the LAN Device.

#### 4.12.8 Email

You can configure the email settings to enable the system to send the email as a notification when there is an alarm event occurs.

**Step 1** Select **Main Menu > NETWORK > EMAIL**.

The **EMAIL** interface is displayed. See Figure 4-213.

Figure 4-213

The screenshot shows a configuration window with the following settings:

- Enable:
- SMTP Server: MailServer
- Port: 25
- Username: (empty)
- Password: (empty)
- Anonymous:
- Receiver: Receiver1
- Email Address: none
- Sender: (empty)
- Subject: NVR ALERT
- Attachment:
- Encryption Type: TLS
- Health Enable:
- Interval: 60 Min.

Buttons at the bottom: Test, Apply, Back.

**Step 2** Configure the settings for the email parameters. See Table 4-59.

Table 4-59

Parameter	Description
Enable	Enable the email function.
SMTP Server	Enter the address of SMTP server of sender's email account.
Port	Enter the port value of SMTP server. The default value setting is 25. You can enter the value according to your actual situation.
User Name	Enter the user name and password of sender's email account.
Password	
Anonymity	If enable the anonymity function, you can login as anonymity.
Mail Receiver	In the <b>Mail Receiver</b> list, select the number of receiver that you want to receive the notification. The Device supports up to three mail receivers.
Email Address	Enter the email address of mail receiver(s).
Sender	Enter the sender's email address. It supports maximum three senders separated by comma.
Title	Enter the email subject. Supports Chinese, English and Arabic numerals. It supports maximum 64 characters.
Attachment	Enable the attachment function. When there is an alarm event, the system can attach snapshots as an attachment to the email.
Authentication	Select the encryption type: <b>NONE</b> , <b>SSL</b> , or <b>TLS</b> .  For SMTP server, the default encryption type is <b>TLS</b> .

Parameter	Description
Interval (Sec.)	This is the interval that the system sends an email for the same type of alarm event, which means, the system does not send an email upon any alarm event. This setting helps to avoid the large amount of emails caused by frequent alarm events. The value ranges from 0 to 3600. 0 means that there is no interval.
Health Enable	Enable the health test function. The system can send a test email to check the connection.
Interval (Min.)	This is the interval that the system sends a health test email. The value ranges from 30 to 1440. 0 means that there is no interval.
Test	Click <b>Test</b> to test the email sending function. If the configuration is correct, the receiver's email account will receive the email.  Before testing, click <b>Apply</b> to save the settings.

Step 3 Click **Apply** to complete the settings.

#### 4.12.9 SNMP



This function is for some series only.

You can connect the Device with some software such as MIB Builder and MG-SOFT MIB Browser to manage and control the Device from the software.

#### Preparations

- Install the software that can manage and control the SNMP, such as MIB Builder and MG-SOFT MIB Browser
- Obtain the MIB files that correspond to the current version from the technical support.

#### Configuration Steps

Step 1 Select **Main Menu > NETWORK > SNMP**.  
The **SNMP** interface is displayed. See Figure 4-214.

Figure 4-214

**Step 2** Configure the settings for the SNMP parameters. See Table 4-60.

Table 4-60

Parameter	Description
Enable	Enable the SNMP function.
Version	Select the check box of SNMP version(s) that you are using. The default version is <b>V3</b> . There is a risk of select V1 or V2.
SNMP Port	Indicates the monitoring port on the agent program.
Read Community	Indicates the read/write strings supported by the agent program.
Write Community	
Trap Address	Indicates the destination address for the agent program to send the Trap information.
Trap Port	Indicates the destination port for the agent program to send the Trap information.
Read Only User	Enter the user name that is allowed to access the Device and has the "Read Only" permission.
Read/Write User	Enter the user name that is allowed to access the Device and has the "Read and Write" permission.
Authentication Type	Includes MD5 and SHA. The system recognizes automatically.
Authentication Password	Enter the password for authentication type and encryption type. The password should be no less than eight characters.
Encryption Password	

Parameter	Description
Encryption Type	In the <b>Encryption Type</b> list, select an encryption type. The default setting is CBC-DES.

Step 3 Compile the two MIB files by MIB Builder.

Step 4 Run MG-SOFT MIB Browser to load in the module from compilation.

Step 5 On the MG-SOFT MIB Browser, enter the Device IP that you want to manage, and then select the version number to query.

Step 6 On the MG-SOFT MIB Browser, unfold the tree-structured directory to obtain the configurations of the Device, such as the channels quantity and software version.

#### 4.12.10 Multicast

When you access the Device from the network to view the video, if the access is exceeded, the video will not display. You can use the multicast function to group the IP to solve the problem.

Step 1 Select **Main Menu > NETWORK > MULTICAST**.

The **MULTICAST** interface is displayed. See Figure 4-215.

Figure 4-215

Enable

IP Address  (224.0.0.0 - 239.255.255.255)

Port  (1025 - 65000)

Step 2 Configure the settings for the multicast parameters. See Table 4-61.

Table 4-61

Parameter	Description
Enable	Enable the multicast function.
IP Address	Enter the IP address that you want to use as the multicast IP. The IP address ranges from 224.0.0.0 through 239.255.255.255.
Port	Enter the port for the multicast. The port ranges from 1025 through 65000.

Step 3 Click **Apply** to complete the settings.

You can use the multicast IP address to login the web.

On the web login dialog box, in the **Type** list, select **MULTICAST**. The web will

automatically obtain the multicast IP address and join. Then you can view the video through multicast function.

#### 4.12.11 Alarm Center

You can configure the alarm center server to receive the uploaded alarm information. To use this function, the **Alarm Upload** check box must be selected.

Step 1 Select **Main Menu > NETWORK > ALARM CENTER**.

The **ALARM CENTER** interface is displayed. See Figure 4-216.

Figure 4-216

Step 2 Configure the settings for the alarm center parameters. See Table 4-62.

Table 4-62

Parameter	Description
Enable	Enable the alarm center function.
Protocol Type	In the <b>Protocol Type</b> list, select protocol type. The default is <b>ALARM CENTER</b> .
Host IP	The IP address and communication port of the PC installed with alarm client.
Port	
Self-Report Time	In the <b>Self-Report Time</b> list, select time cycle and specific time for uploading alarm.

Step 3 Click **Apply** to complete the settings.

#### 4.12.12 Register

You can register the Device into the specified proxy server which acts as the transit to make it easier for the client software to access the Device.

Step 1 Select **Main Menu > NETWORK > REGISTER**.

The **REGISTER** interface is displayed. See Figure 4-217.



Figure 4-217

Step 2 Configure the settings for the register parameters. See Table 4-63.

Table 4-63

Function	Description
Enable	Enable the register function.
Server IP Address	Enter the server IP address or the server domain that you want to register to.
Port	Enter the port of the server.
Sub Service ID	This ID is allocated by the server and used for the Device.

Step 3 Click **Apply** to complete the settings.

#### 4.12.13 P2P

P2P is a kind of convenient private network penetration technology. You do not need to apply for dynamic domain name, doing port mapping or deploying transit server. You can add NVR devices through the below way to achieve the purpose of managing multiple NVR devices at the same time.

- Scan the QR code, download mobile app, and then register an account. For details, see Mobile App Operation.
- Log in [www.gotop2p.com](http://www.gotop2p.com), register an account, and then add device via the serial number. For details, see Introduction of P2P Operations.



Connect the NVR device to the Internet, otherwise P2P can not run properly.

Step 1 Select **Main Menu > NETWORK > P2P**.

The **P2P** interface is displayed. See Figure 4-218.

Figure 4-218

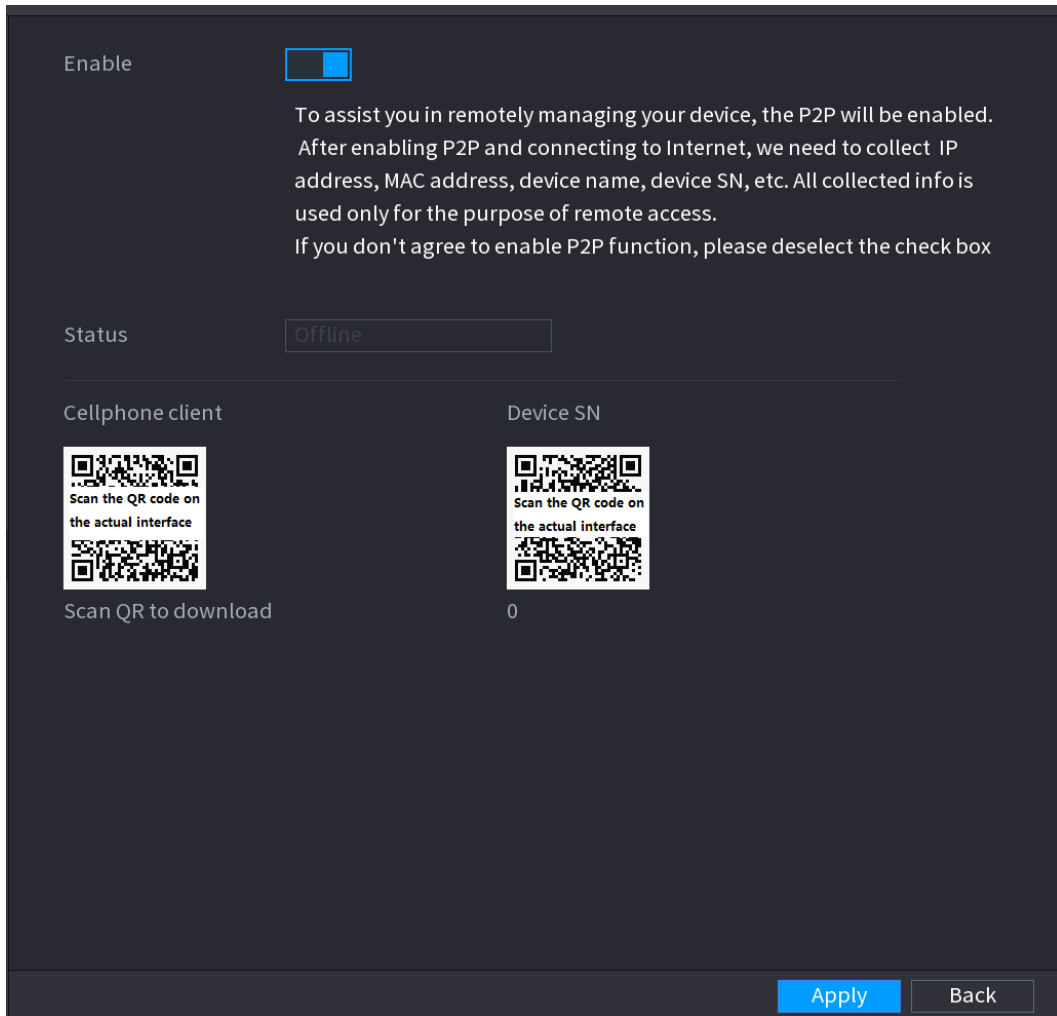

**Step 2** Enable the P2P function.



After the P2P function is enabled and connected to the Internet, the system will collect your information for remote access, and the information includes but not limited to email address, MAC address, and device serial number.

You can start adding the device.

- Cell Phone Client: Use your mobile phone to scan the QR code to add the device into the Cell Phone Client, and then you can start accessing the Device.
- Platform: Obtain the Device SN by scanning the QR code. Go to the P2P management platform and add the Device SN into the platform. Then you can access and manage the device in the WAN. For details, refer to the P2P operation manual.



You can also enter the QR code of Cell Phone Client and Device SN by clicking  on the top right of the interfaces after you have entered the Main Menu.

To use this function, take adding device into Cell Phone Client as an example.

## Mobile APP Operation

The following contents are introduced in the example of mobile App.

**Step 1** Scan the QR code to download and install the mobile App.

**Step 2** Select Camera and enter the main interface.

**Step 3** Register device in the mobile App:

- 1) Click  and select Device Manager. See Figure 4-219.

Figure 4-219

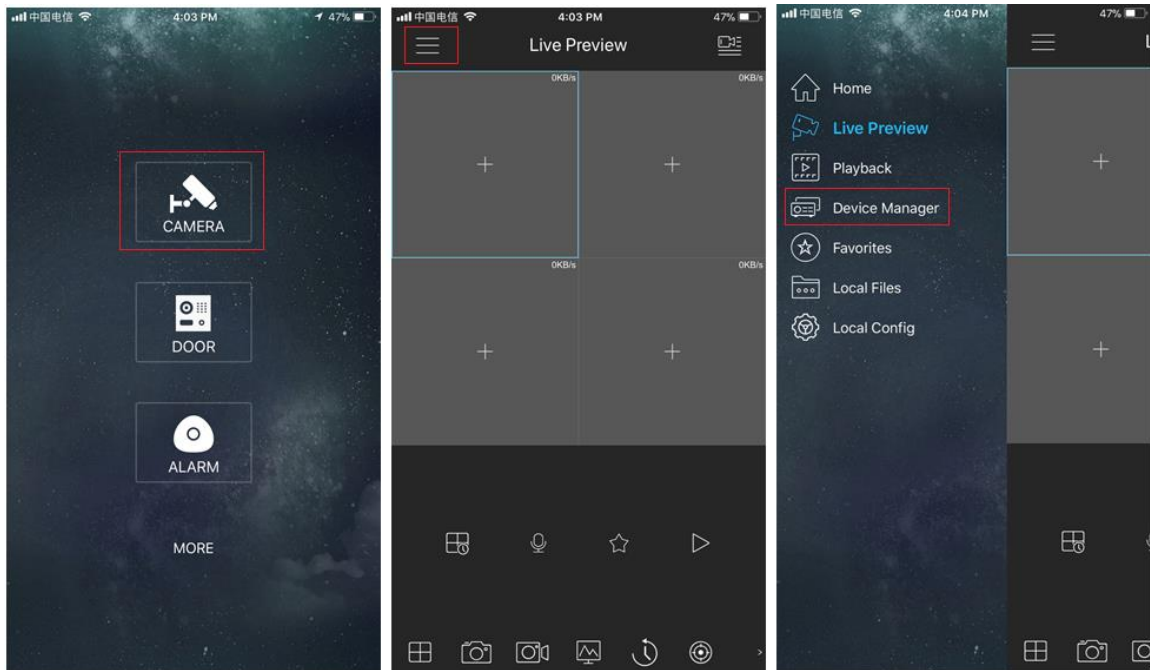

- 2) Click  and enter the Add Device interface.



Mobile App supports device initialization.

- 3) Select **Wired Device > P2P** to enter the P2P interface.
- 4) Click the QR code icon behind the SN to enter the QR code scan interface.
- 5) Scan the device label or scan the SN QR code got by selecting **Main Menu > Network > P2P**. When the scan is successful, the device SN will be displayed in the SN item.
- 6) Enter name and password.

Step 4 After device registration on mobile App, click Start Preview and you can see the monitor screen.

## 4.13 Storage

You can manage the storage resources (such as record file) and storage space. So that it is easy for you to use and enhance storage space usage.

### 4.13.1 Basic

You can set basic storage parameters.

- Step 1 Select **Main Menu > STORAGE > BASIC**.  
The **Basic** interface is displayed. See Figure 4-220.

Figure 4-220

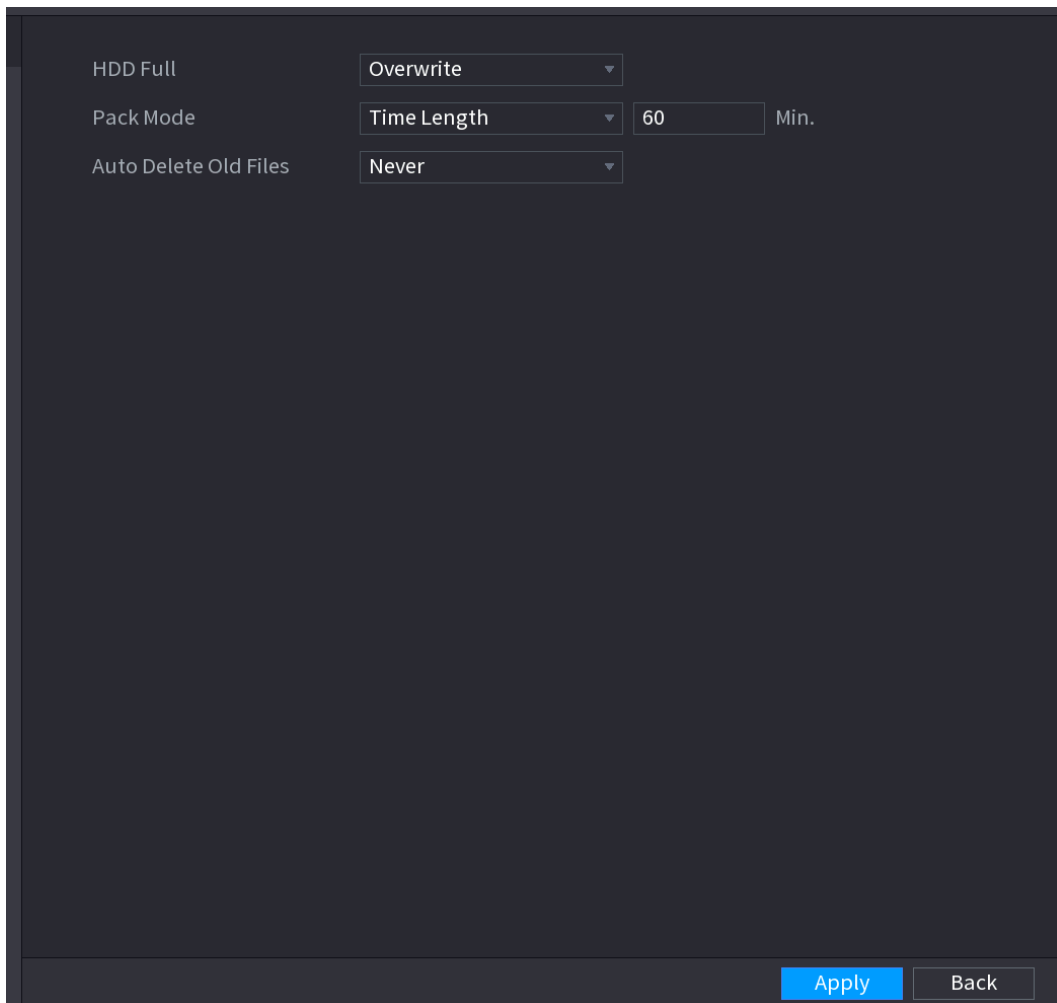

**Step 2** Set parameters. See Table 4-64.

Table 4-64

Parameter	Description
HDD Full	Configure the settings for the situation all the read/write discs are full, and there is no more free disc. <ul style="list-style-type: none"> <li>● Select <b>Stop Record</b> to stop recording</li> <li>● Select <b>Overwrite</b> to overwrite the recorded video files always from the earliest time.</li> </ul>
Pack Mode	Configure the time length and file length for each recorded video.
Auto-Delete Old Files	Configure whether to delete the old files and if yes, configure the days.  The auto delete file cannot be recovered!

**Step 3** Click **Apply** or **Save** to complete setup.

### 4.13.2 Schedule

You can set schedule record and schedule snapshot. NVR can record or snapshot as you specified. For detailed information, refer to "4.1.4.6.1 Schedule Record" and "4.1.4.6.2 Schedule Snapshot".

### 4.13.3 HDD

You can view and sett HDD properties and format HDD.

You can view current HDD type, status, capacity and etc. The operation includes format HDD, and change HDD property (read and write/read-only/redundancy).

- To prevent files be overwritten in the future, you can set HDD as read-only.
- To backup recorded video file, you can set HDD as redundant HDD.

**Step 1** Select **Main Menu > Storage > HDD MANAGER**,  
The **HDD MANAGER** interface is displayed. See Figure 4-221.

Figure 4-221

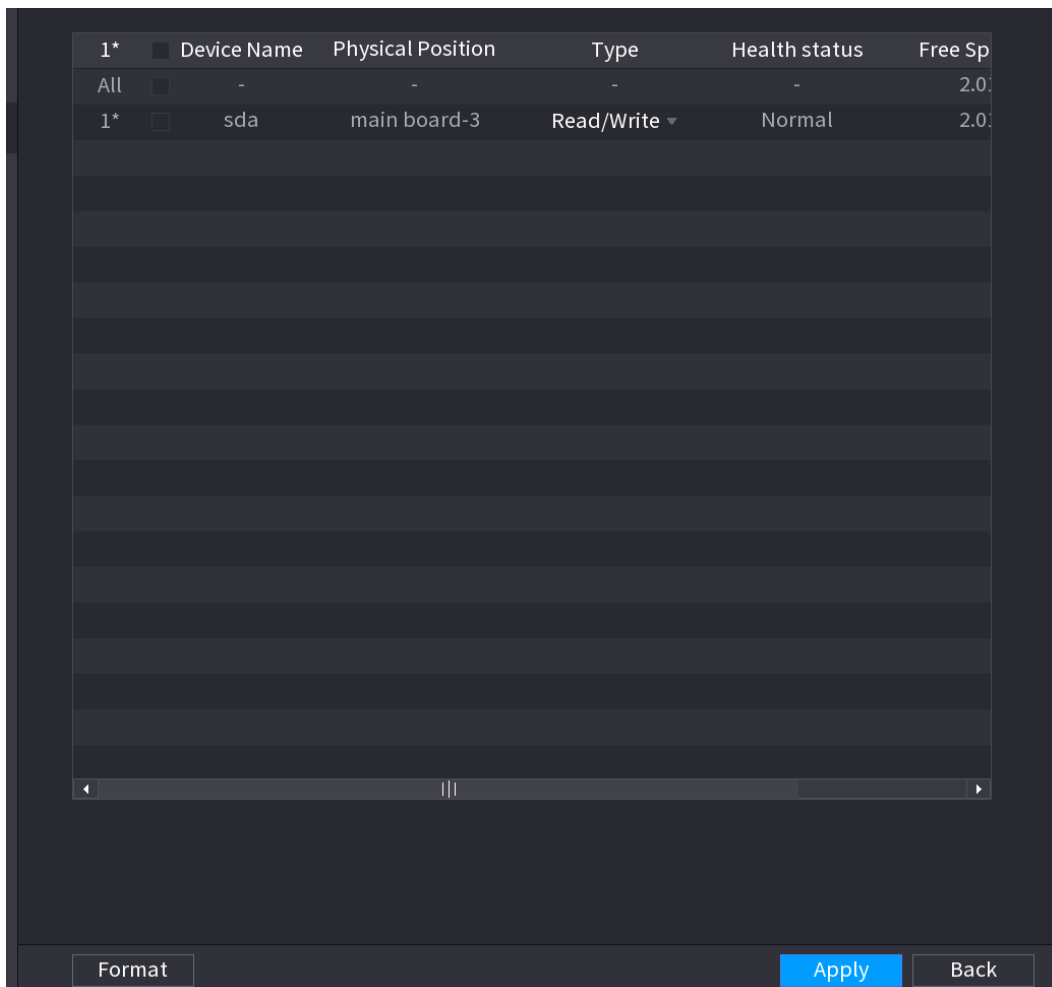

**Step 2** Select a HDD and then select a time from the dropdown list.

**Step 3** Click **Apply** button to complete the setup. System needs to restart to activate current setup if you want to format the HDD.

#### 4.13.4 Record Control

After you set schedule record or schedule snapshot function, set auto record/snapshot function so that the NVR can automatically record or snapshot. For detailed information, refer to "4.1.4.6.3 Record Control".

#### 4.13.5 Advance (HDD Group)

You can set HDD group, and HDD group setup for main stream, sub stream and snapshot operation.



When you are setting HDD group, set a HDD for each channel, otherwise NVR cannot save current setup.

**Step 1** Select **Main Menu > STORAGE > ADVANCED**.

The **ADVANCED** interface is displayed. See Figure 4-222.

Figure 4-222

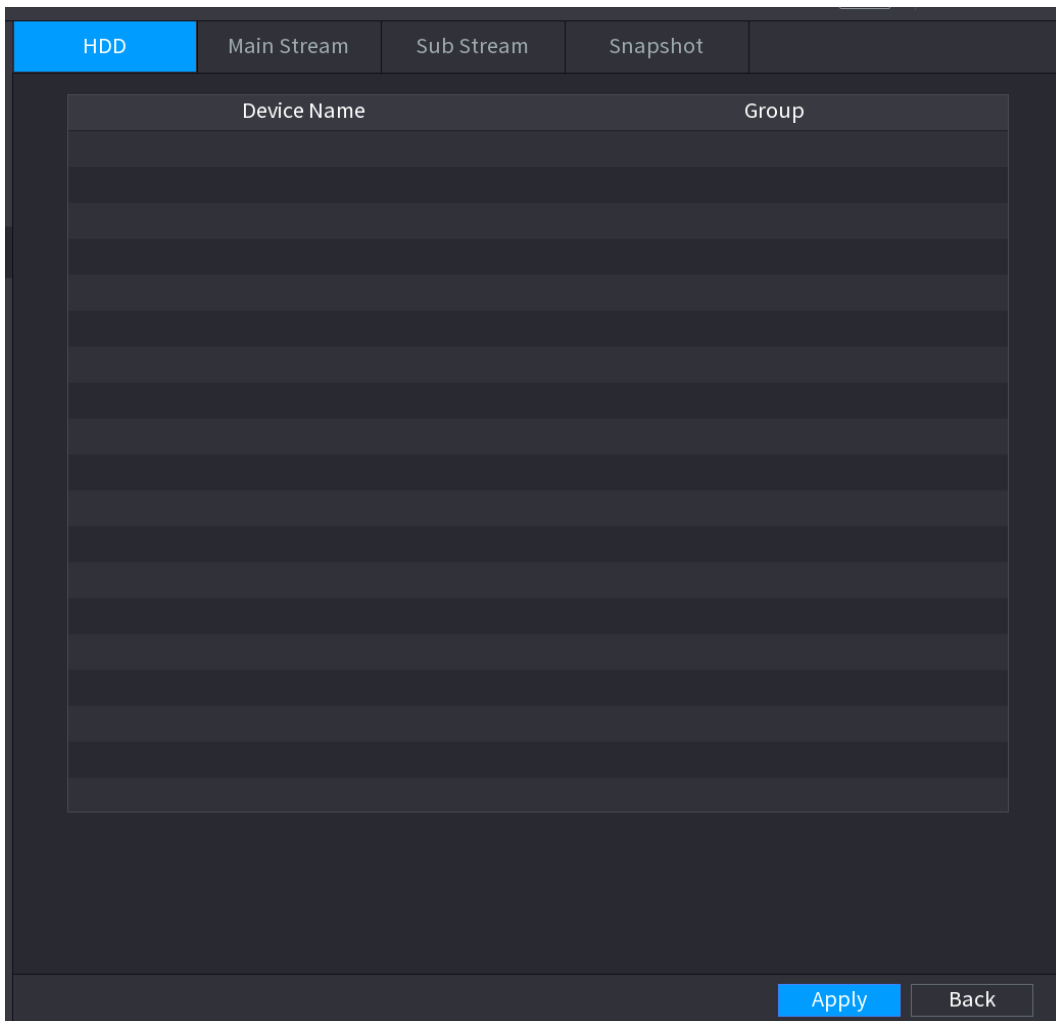

**Step 2** Select the group for each HDD group, and then click **Save** to save the settings.

After configuring HDD group, under the **Main Stream** tab, **Sub Stream** tab and **Snapshot** tab, configure settings to save the main stream, sub stream and snapshot to different HDD group as selected by you.

#### 4.13.6 HDD Detect



This function is for some series product only.

The HDD detect function is to detect HDD current status so that you can clearly understand the HDD performance and replace the malfunction HDD.

There are two detect types:

- Quick detect is to detect via the universal system files. System can quickly complete the HDD scan. If you want to use this function, make sure the HDD is in use now. If the HDD is removed from other device, make sure the HDD once storage the record files when installed on current device.
- Global detect adopts Windows mode to scan. It may take a long time and may affect the HDD that is recording.

##### 4.13.6.1 Manual Detect

**Step 1** Select **Main Menu > STORAGE > HDD DETECT > Manual Detect**.

The **Manual Detect** interface is displayed. See Figure 4-223.

Figure 4-223

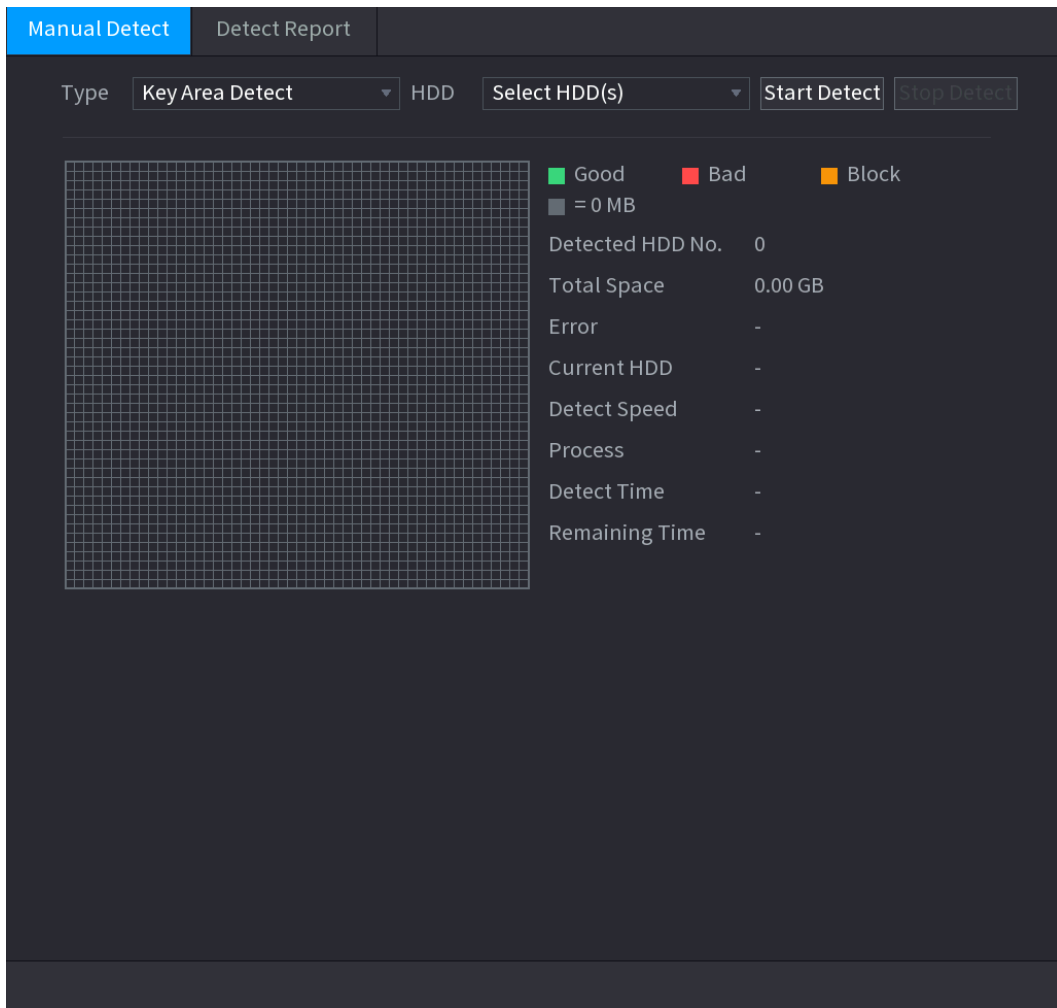

**Step 2** In the **Type** list, select **Key Area Detect** or **Global Detect**; and in the **HDD** list, select the HDD that you want to detect.

**Step 3** Click **Start Detect**.

The system starts detecting the HDD and displays the detection information.



When system is detecting HDD, click **Stop Detect** to stop current detection. Click **Start Detect** to detect again.

#### 4.13.6.2 Detect Report

After the detect operation, you can go to the detect report to view corresponding information. Replace the malfunction HDD in case there is data loss.

**Step 1** Select **Main Menu > STORAGE > HDD DETECT > Detect Report**.

The **Detect Report** interface is displayed. See Figure 4-224.

Figure 4-224

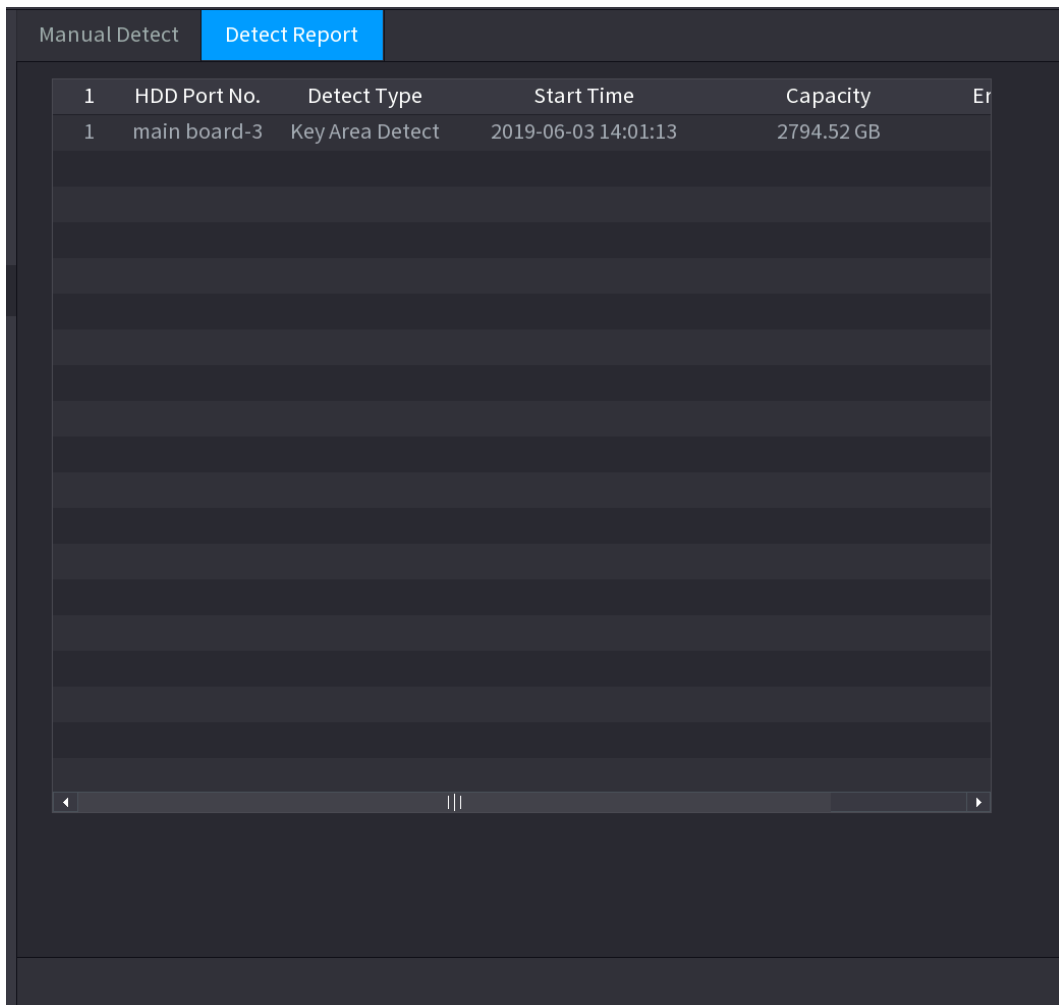

The screenshot shows a software interface with a dark theme. At the top, there are two tabs: 'Manual Detect' and 'Detect Report', with 'Detect Report' being the active tab. Below the tabs is a table with the following data:

1	HDD Port No.	Detect Type	Start Time	Capacity	Er
1	main board-3	Key Area Detect	2019-06-03 14:01:13	2794.52 GB	

The table is contained within a scrollable area, as indicated by the scrollbar at the bottom of the table container.

**Step 2** Click .

The **Details** interface is displayed. You can view detecting results and S.M.A.R.T reports. See Figure 4-225 and Figure 4-226.



Figure 4-225

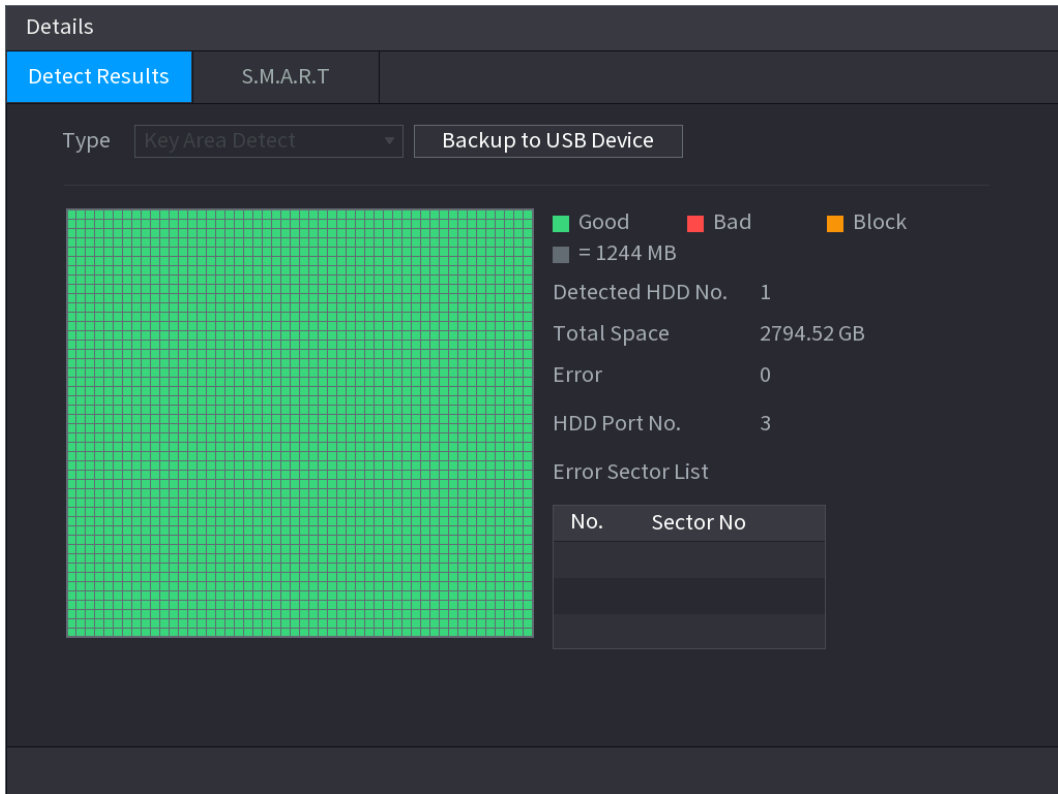
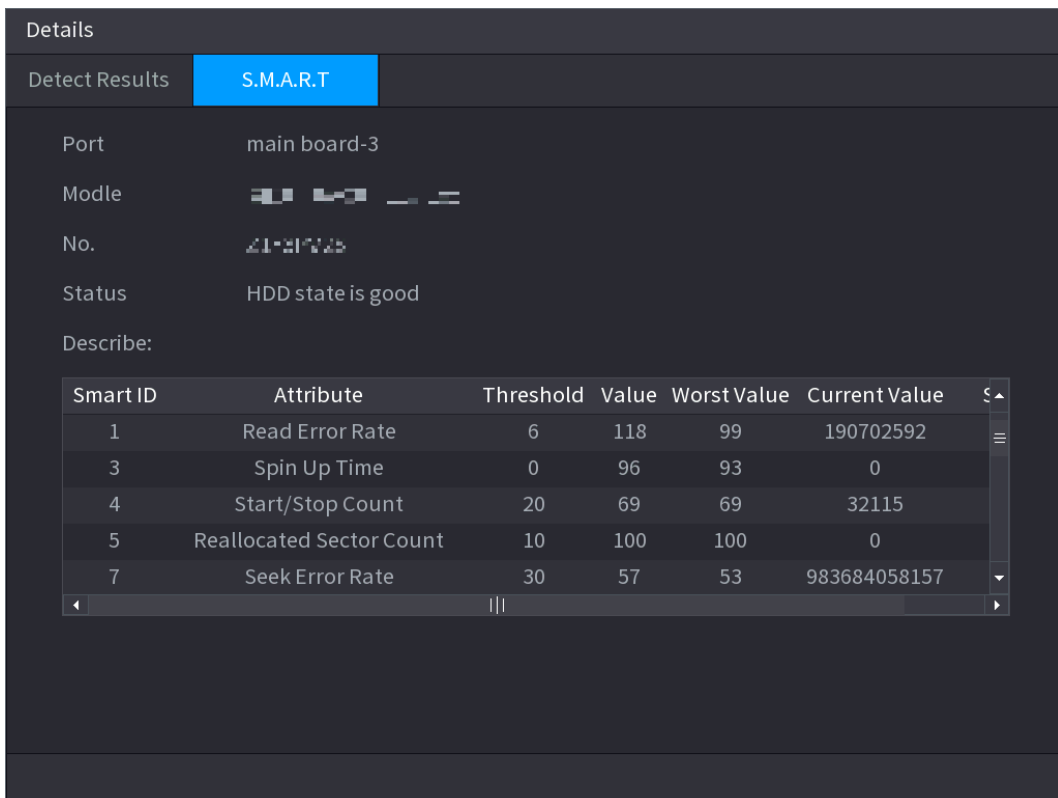

Figure 4-226



#### 4.13.7 RAID

RAID (redundant array of independent disks) is a data storage virtualization technology that combines multiple physical HDD components into a single logical unit for the purposes of data redundancy, performance improvement, or both.



- RAID function is for some series products only. Slight difference may be found on the user interface.
- The NVR supports RAID0, RAID1, RAID5, RAID6, and RAID 10. Local hot spare supports RAID1, RAID5, RAID6, and RAID10.

For the disk quantity required for each RAID type. See Table 4-65.

Table 4-65

RAID type	Required disk quantity
RAID0	At least 2.
RAID1	Only 2.
RAID5	At least 3, and using 4 disks to 6 disks is recommended.
RAID6	At least 4.
RAID10	At least 4.

#### 4.13.7.1 Creating Manager

RAID has different levels (such as RAID5, RAID6). Each level has different data protection, data availability, and performance grade.

You can manually create RAID or just one click one button to create RAID. For create RAID function, you can select the physical HDD that does not included in the RAID group or the created disk array to create a RAID5. You can refer to the following situations:

- There is no RAID, no hotspare disk: System directly creates the RAID5 and creates one hotspare disk at the same time.
- There is no RAID, but there is a hotspare disk: System creates the RAID5 only. It uses previous hotspare disk.
- There is RAID: System cancel the previous RAID setup and then create the new RAID5. System creates the hotspare disk if there is no one. System uses previous hotspare disk if there is hotspare disk available.
- The background will format the virtual disk.

You can create different types of RAID as needed.

Step 1 Select **Main Menu > STORAGE > RAID > RAID**.  
The **RAID** interface is displayed. See Figure 4-227.

Figure 4-227

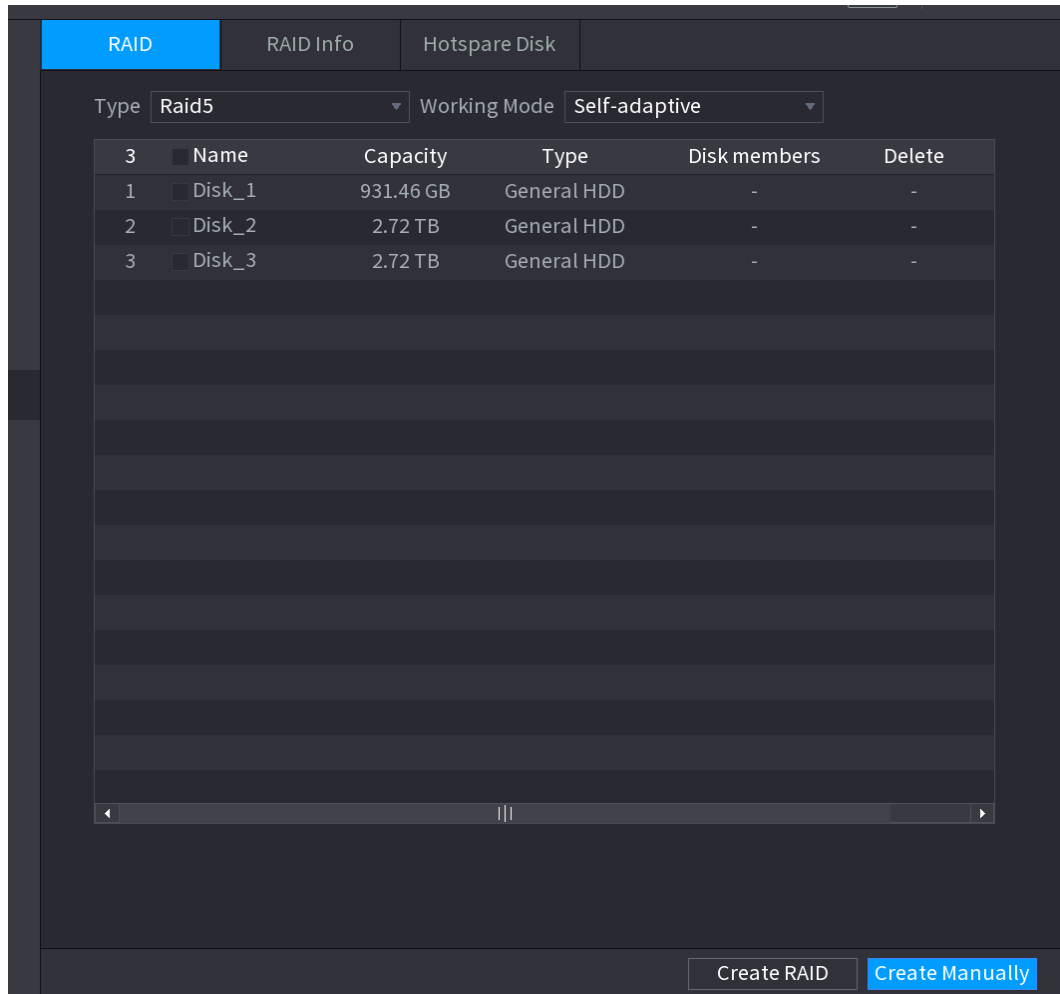

**Step 2** You can click **Create RAID** or **Create Manually**, and all the disks involved will be formatted.

- Click **Create RAID**, the system will create RAID automatically.
  - ◇ If there is no existing RAID and no hot spare disk, the system will create RAID5 and a hot spare disk automatically.
  - ◇ If there is no existing RAID, but existing hot spare disk, the system will only create RAID5 and use the existing hot spare disk automatically.
  - ◇ If there is existing RAID and existing hot spare disk, the system will delete the original RAID and create RAID5 with all the disks and use the existing hot spare disk automatically.
- Click **Create Manually**.
  - 1) Select RAID type and disks as system instructed.
  - 2) Click **Create Manually**, and then the format disk notice is displayed.
  - 3) Click **OK**.

**Step 3** After creating RAID, the disks need to sync with each other to finish the process. For RAID5 and RAID6, you can select different working mode.

- **Self-Adaptive**: Automatically adjust the RAID sync speed according to the business status.
  - ◇ When there is no business running, sync is performed at a high speed.
  - ◇ When there is business running, sync is performed at a low speed.
- **Sync First**: Resource priority is assigned to RAID sync.
- **Business First**: Resource priority is assigned to business operations.
- **Balance**: Resource is evenly distributed to RAID sync and business operations.

#### 4.13.7.2 Raid Info

You can view the existing RAID information, including type, disk space, hot spare, and status. Select **Main Menu > STORAGE > RAID > RAID Info**.



Figure 4-229

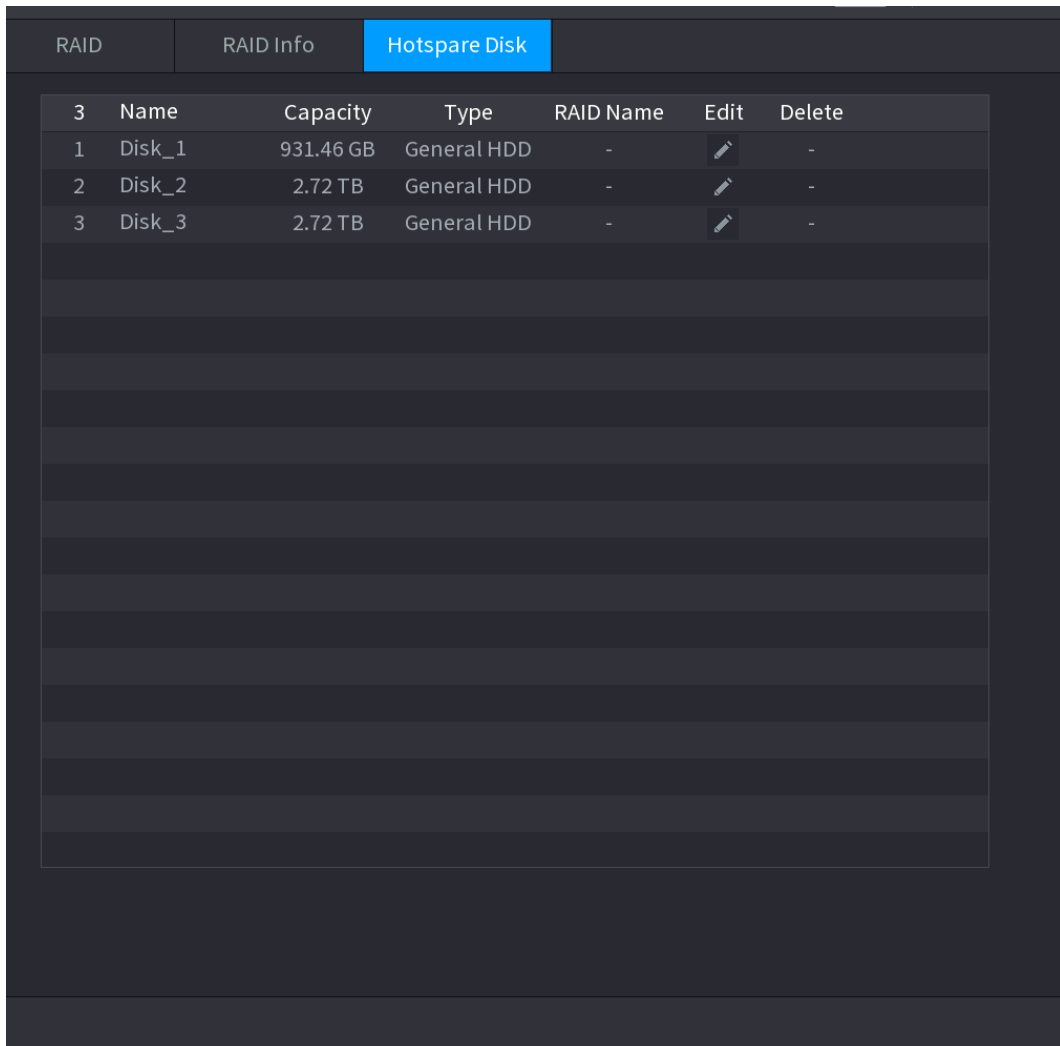

- Step 2** Click the  icon behind a disk.
- Step 3** The **New Hotspare** interface is displayed. See Figure 4-230 (New hot spare (local)) or Figure 4-231 (New hot spare (global)).

Figure 4-230

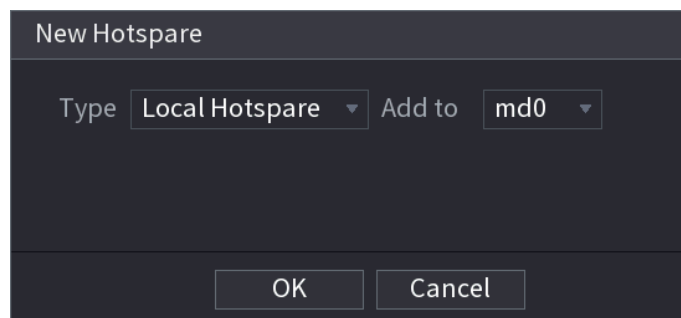
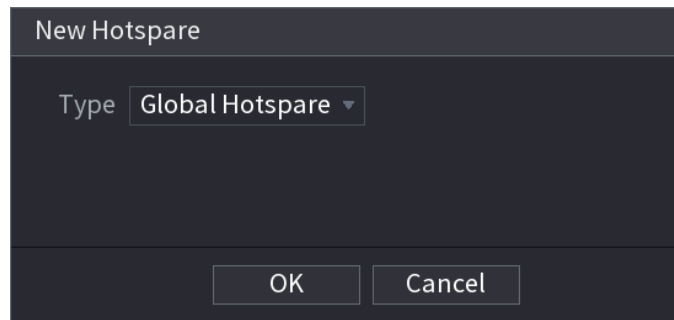

Figure 4-231



**Step 4** You can select **Local Hotspare** or **Global Hotspare**.

- **Local Hotspare:** Select the target disk, and the new disk will serve as the hot spare disk of the selected disk.
- **Global Hotspare:** the new disk will serve as the hot spare disk of the entire RAID.

**Step 5** Click **OK**.



Click  behind a hot spare disk to delete it.

#### 4.13.8 Record Estimate

Record estimate function can calculate how long you can record video according to the HDD capacity, and calculate the required HDD capacity according to the record period.

**Step 1** Select **Main Menu > STORAGE > REC ESTIMATE**.

The **REC ESTIMATE** interface is displayed. See Figure 4-232.

Figure 4-232

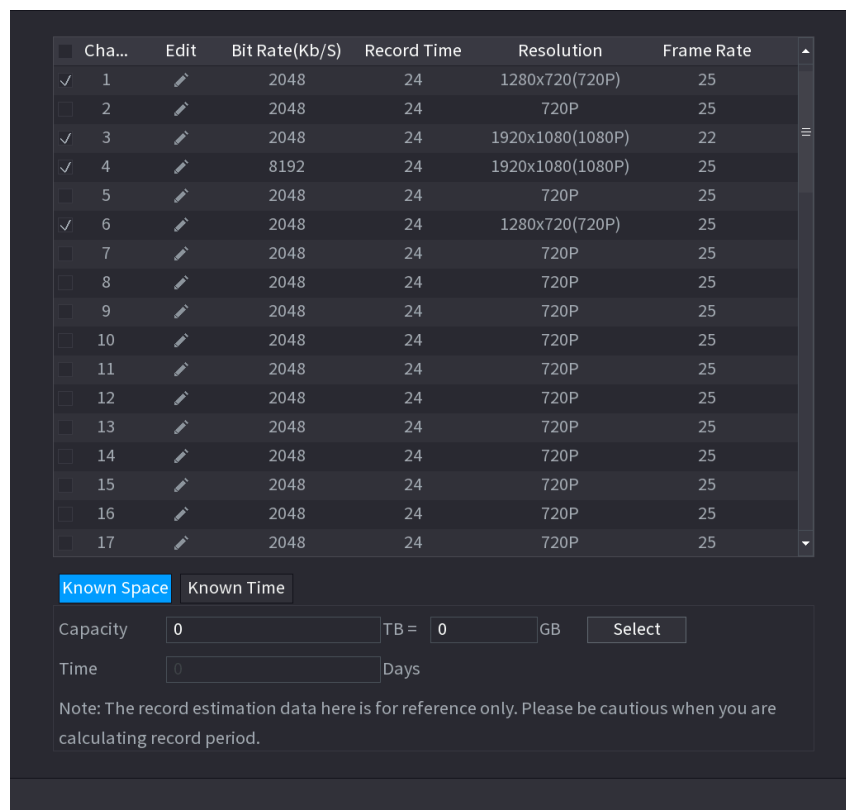

**Step 2** Click .

The **Edit** dialogue box is displayed. See Figure 4-233.

You can configure the **Resolution**, **Frame Rate**, **Bit Rate** and **Record Time** for the selected channel.

Figure 4-233

Edit

Channel 1

Resolution 1280x720(720P)

Frame Rate 25

Bit Rate 2048 Kb/S

Record Time 24 Hour

Copy Apply Back

**Step 3** Click **Apply** to save the settings.  
Then the system will calculate the time period that can be used for storage according to the channels settings and HDD capacity.



Click **Copy** to copy the settings to other channels.

## Calculating Recording Time

**Step 1** On the **REC ESTIMATE** interface, click the **Known Space** tab.  
The **Known Space** interface is displayed. See Figure 4-234.

Figure 4-234

Known Space Known Time

Capacity 0 TB = 0 GB Select

Time 0 Days

Note: The record estimation data here is for reference only. Please be cautious when you are calculating record period.

**Step 2** Click **Select**.  
The **Select HDD(s)** interface is displayed.

**Step 3** Select the check box of the HDD that you want to calculate.  
In the **Known Space** tab, in the **Time** box, the recording time is displayed. See Figure 4-235.

Figure 4-235

Known Space Known Time

Capacity 7 TB = 7000 GB Select

Time 9 Days

Note: The record estimation data here is for reference only. Please be cautious when you are calculating record period.

## Calculating HDD Capacity for Storage

**Step 1** On the **REC ESTIMATE** interface, click the **Known Time** tab.  
The **Known Time** interface is displayed. See Figure 4-236.

Figure 4-236

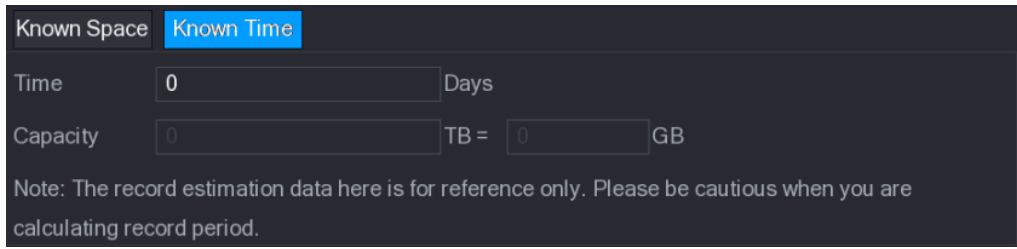

Known Space **Known Time**

Time  Days

Capacity  TB =  GB

Note: The record estimation data here is for reference only. Please be cautious when you are calculating record period.

- Step 2** In the **Time** box, enter the time period that you want to record.  
In the **Capacity** box, the required HDD capacity is displayed.

#### 4.13.9 FTP

You can store and view the recorded videos and snapshots on the FTP server.

#### Preparations

Purchase or download a FTP (File Transfer Protocol) server and install it on your PC.



For the created FTP user, you need to set the write permission; otherwise the upload of recorded videos and snapshots will be failed.

- Step 1** Select **Main Menu > STORAGE > FTP**.  
The **FTP** interface is displayed. See Figure 4-237.

Figure 4-237

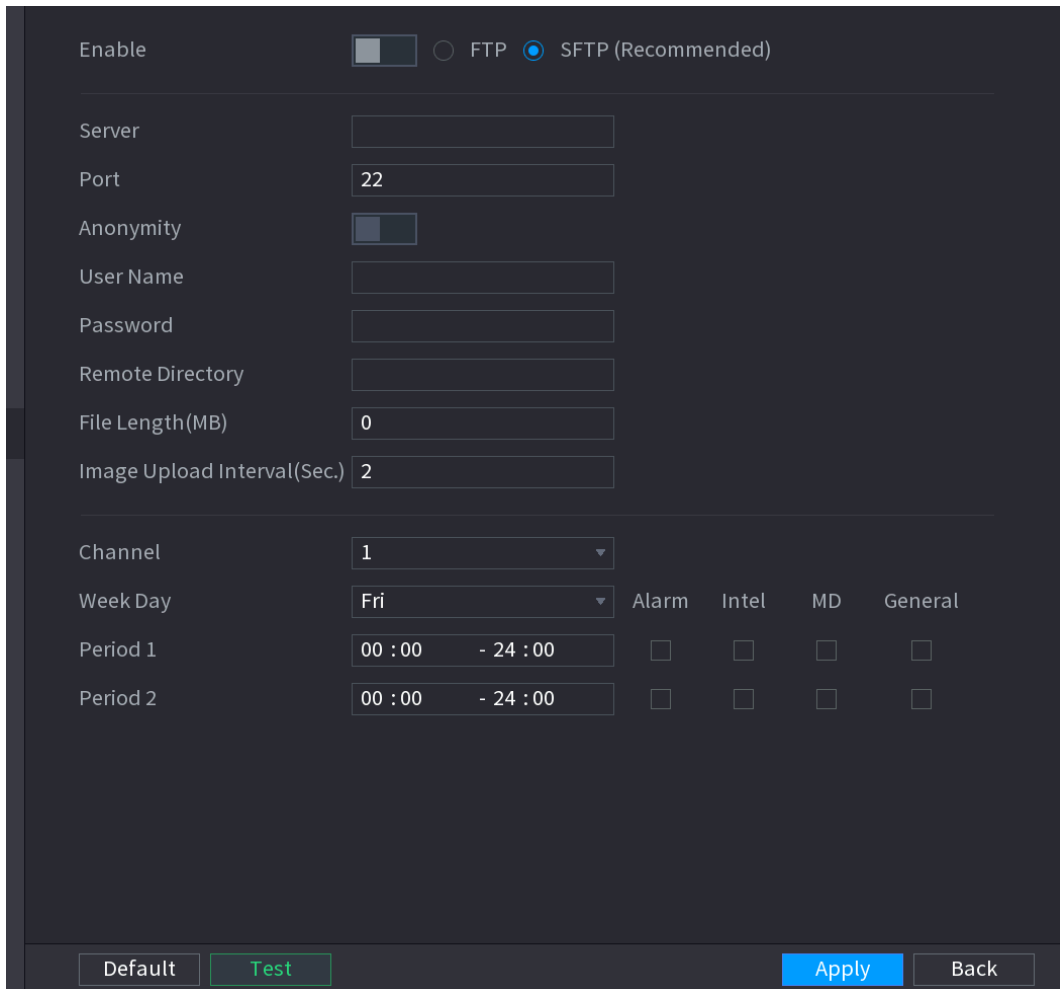

Enable  FTP  SFTP (Recommended)

Server

Port

Anonymity

User Name

Password

Remote Directory

File Length(MB)

Image Upload Interval(Sec.)

Channel

Week Day  Alarm Intel MD General

Period 1

Period 2

Default Test Apply Back

- Step 2** Configure the settings for the FTP settings parameters. See Table 4-66.



Table 4-66

Parameter	Description
Enable	<ul style="list-style-type: none"> <li>Enable the FTP upload function.</li> </ul>
FTP type	<ul style="list-style-type: none"> <li>Select FTP type.</li> <li>FTP: Plaintext transmission.</li> <li>SFTP: Encrypted transmission (recommended)</li> </ul>
Server	IP address of FTP server.
Port	<ul style="list-style-type: none"> <li>FTP: The default is 21.</li> <li>SFTP: The default is 22.</li> </ul>
Anonymity	Enter the user name and password to login the FTP server. Enable the anonymity function, and then you can login anonymously without entering the user name and password.
User Name	
Password	
Remote Directory	<p>Create folder on FTP server.</p> <ul style="list-style-type: none"> <li>If you do not enter the name of remote directory, system automatically creates the folders according to the IP and time.</li> <li>If you enter the name of remote directory, the system creates the folder with the entered name under the FTP root directory first, and then automatically creates the folders according to the IP and time.</li> </ul>
File Length(M)	<p>Enter the length of the uploaded recorded video.</p> <ul style="list-style-type: none"> <li>If the entered length is less than the recorded video length, only a section of the recorded video can be uploaded.</li> <li>If the entered length is more than the recorded video length, the whole recorded video can be uploaded.</li> <li>If the entered length is 0, the whole recorded video will be uploaded.</li> </ul>
Image Upload Interval (Sec.)	<ul style="list-style-type: none"> <li>If this interval is longer than snapshot interval, the system takes the recent snapshot to upload. For example, the interval is 5 seconds, and snapshot interval is 2 seconds per snapshot, the system uploads the recent snapshot every 5 seconds.</li> <li>If this interval is shorter than snapshot interval, the system uploads the snapshot per the snapshot interval. For example, the interval is 5 seconds, and snapshot interval is 10 seconds per snapshot, the system uploads the snapshot every 10 seconds.</li> <li>To configure the snapshot interval, select <b>Main Menu &gt; CAMERA &gt; ENCODE &gt; Snapshot</b>.</li> </ul>
Channel	Select the channel that you want to apply the FTP settings.
Week Day	Select the week day and set the time period that you want to upload the recorded files. You can set two periods for each week day.
Period 1, Period 2	
Record type	Select the record type (Alarm, Intel, MD, and General) that you want to upload. The selected record type will be uploaded during the configured time period.

**Step 3** Click **Test**.

The system pops up a message to indicate success or failure. If failed, check the network connection or configurations.

**Step 4** Click **Apply** to complete the settings.

## 4.14 System

### 4.14.1 General

You can set device general information. It includes device information, system date. Refer to "4.1.4.1 General" for detailed information.

### 4.14.2 RS232

After setting RS-232 parameters, the NVR can use the COM port to connect to other device to debug and operate.

**Step 1** Select **MAIN MENU > SYSTEM > RS232**.  
The **RS232** interface is displayed. See Figure 4-238.

Figure 4-238

The screenshot shows a configuration screen for RS232 settings. It features five rows of settings, each with a label on the left and a dropdown menu on the right. The settings are: Function (Console), Baud Rate (115200), Data Bits (8), Stop Bits (1), and Check (None). At the bottom right of the screen, there are two buttons: a blue 'Apply' button and a grey 'Back' button.

**Step 2** Configure parameters. See Table 4-67.

Table 4-67

Parameter	Description
Function	<p>Select serial port control protocol.</p> <ul style="list-style-type: none"> <li>• Console: Upgrade the program and debug with the console and mini terminal software.</li> <li>• Keyboard: Control this Device with special keyboard.</li> <li>• Adapter: Connect with PC directly for transparent transmission of data.</li> <li>• Protocol COM: Configure the function to protocol COM, in order to overlay card number.</li> <li>• PTZ Matrix: Connect matrix control.</li> <li>• </li> <li>• Different series products support different RS232 functions. The actual product shall prevail.</li> </ul>
Baud Rate	Select Baud rate, which is 115200 by default.
Data Bits	It ranges from 5 to 8, which is 8 by default.
Stop Bits	It includes 1 and 2.
Parity	It includes none, odd, even, mark and null.

**Step 3** Click **Apply**.

## 4.15 Security

You can set security options to strengthen device security and use the device in a much safer way.

## 4.15.1 Security Status

Security scanning helps get a whole picture of device security status. You can scan user, service and security module status for detailed information about the security status of the device.

### Detecting User and Service



Green icon represents a healthy status of the scanned item, and orange icon represents a risky status.

- Login authentication: When there's a risk in the device configuration, the icon will be in orange to warn risk. You can click **Details** to see the detailed risk description.
- User Status: When one of device users or Onvif users uses weak password, the icon will be in orange to warn risk. You can click **Details** to optimize or ignore the risk warning. See Figure 4-239 and Figure 4-240.

Figure 4-239 Security status

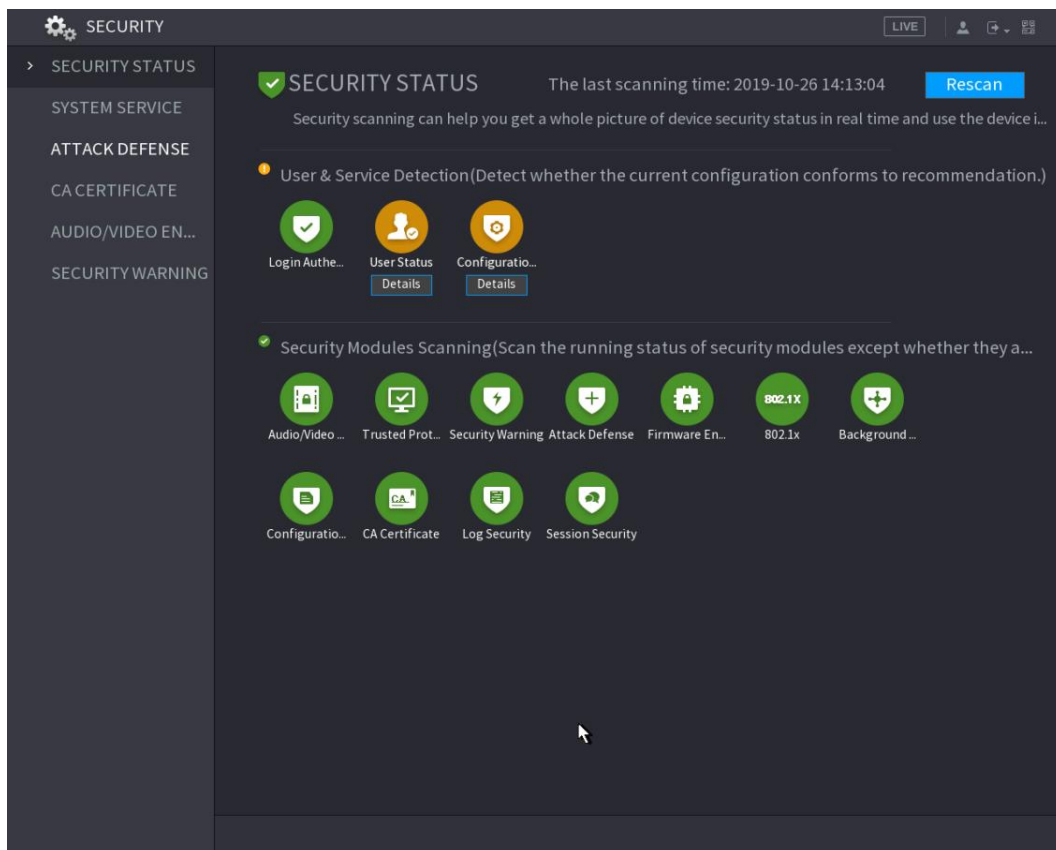
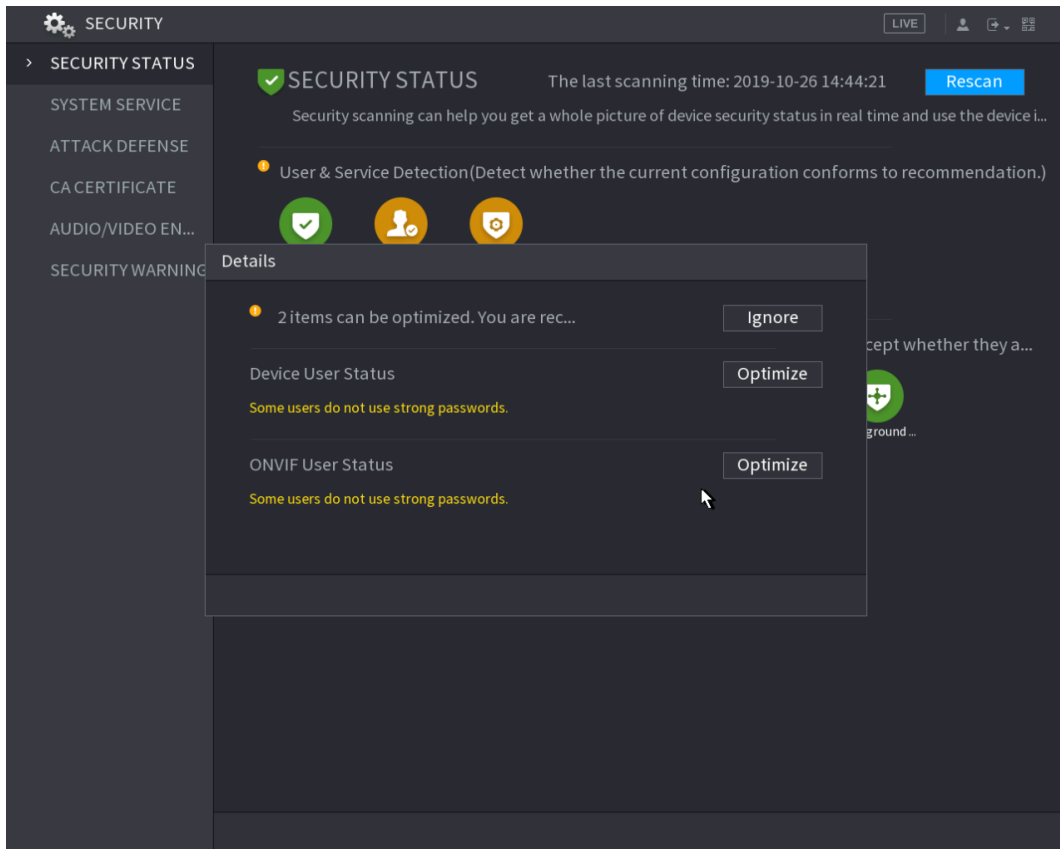
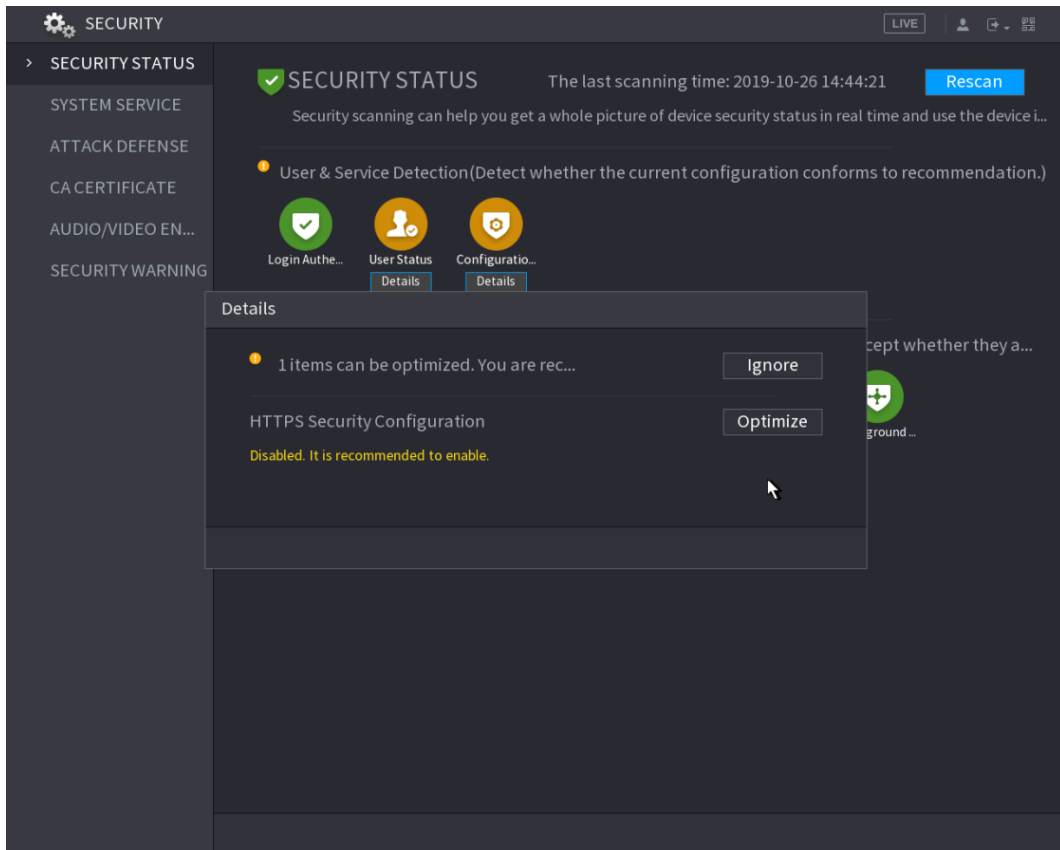

Figure 4-240 User status



- Configuration Security: When **HTTPSEnable** in **SYSTEM SERVICE > HTTPS** is disabled, the icon will be in orange to warn risk. You can click **Details** to optimize or ignore the risk warning. See Figure 4-241.

Figure 4-241 Configuration security



## Scanning Security Modules

This area shows the security modules that are integrated in the current version.

## Scanning Security Status

You can click **Rescan** to scan security status.

## 4.15.2 System Service

You can set NVR basic information such as basic services, 802.1x and HTTPS.

### 4.15.2.1 Basic Services

You can set NVR basic information such as basic services, 802.1x and HTTPS.

**Step 1** Select **Main Menu > SECURITY > SYSTEM SERVICE > Basic Services**.

The **Basic Services** interface is displayed. See Figure 4-242.

Figure 4-242 Basic services interface

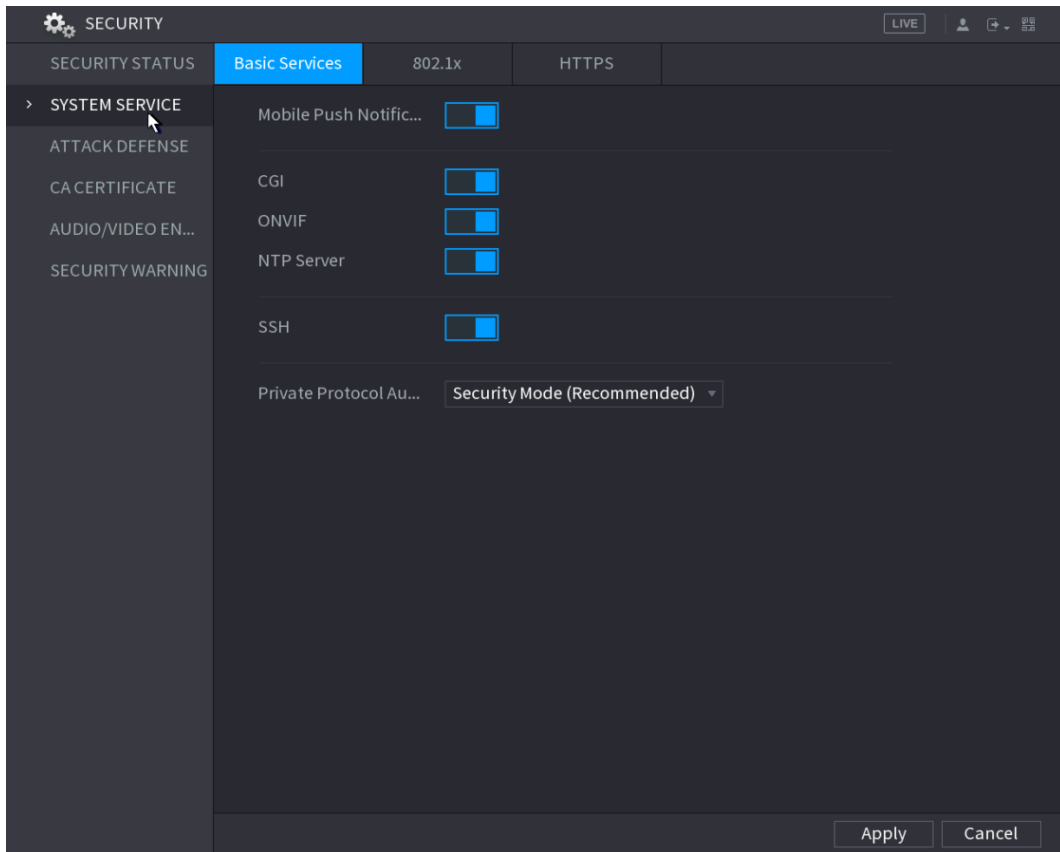

**Step 2** Select **Basic Services** and configure parameters. See Table 4-68.



There might be safety risk when **Mobile Push Notifications**, **CGI**, **ONVIF**, **SSH** and **NTP Server** is enabled.

Table 4-68 Basic service parameters

Parameter	Description
Mobile Notifications Push	After enabling this function, the alarm triggered by the NVR can be pushed to a mobile phone. This function is enabled by default.
CGI	If this function is enabled, the remote devices can be added through the CGI protocol. This function is enable by default.
ONVIF	If this function is enabled, the remote devices can be added through the ONVIF protocol. This function is enabled by default.
NTP Server	After enabling this function, a NTP server can be used to synchronize the device. This function is enabled by default.
SSH	After enabling this function, you can use SSH service. This function is disabled by default.
Private Protocol Authentication Mode	<ul style="list-style-type: none"> <li>Security Mode (Recommended): Uses Digest access authentication when connecting to NVR.</li> <li>Compatible Mode: Select this mode when the client does not support Digest access authentication.</li> </ul>

**Step 3** Click **Apply** to complete the settings.

### 4.15.2.2 802.1x

The device needs to pass 802.1x certification to enter the LAN.

**Step 1** Select **Main Menu > SECURITY > SYSTEM SERVICE > 802.1x**.

The **802.1x** interface is displayed. See Figure 4-243.

Figure 4-243 802.1x interface

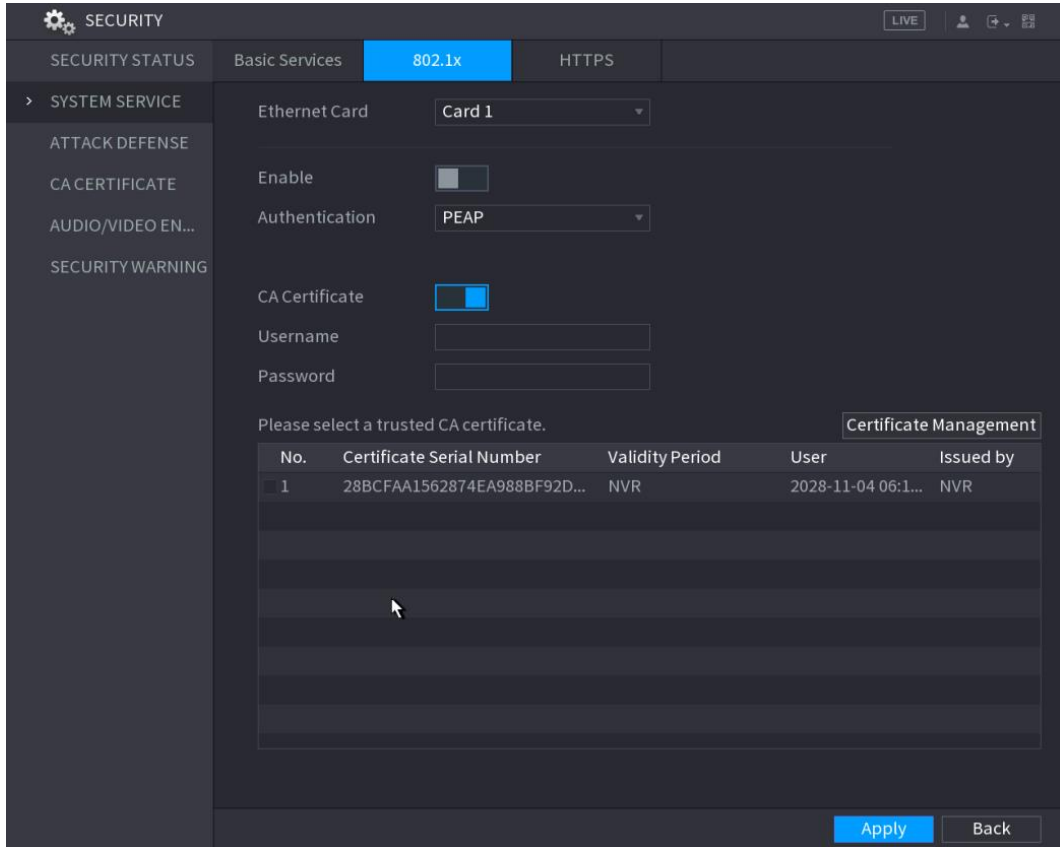

**Step 2** Select the Ethernet card you want to certify.

**Step 3** Select **Enable** and configure parameters. See Table 4-69.

Table 4-69 802.1x parameters

Parameter	Description
Authentication	<ul style="list-style-type: none"><li>• PEAP: protected EAP protocol.</li><li>• TLS: Transport Layer Security. Provide privacy and data integrity between two communications application programs.</li></ul>
CA Certificate	Enable it and click <b>Browse</b> to import CA certificate from flash drive.
Username	The username shall be authorized at server.
Password	Password of the corresponding username.

**Step 4** Click **Apply** to complete the settings.

### 4.15.2.3 HTTPS

We recommend that you enable HTTPS function to enhance system security.

**Step 1** Select **Main Menu > SECURITY > SYSTEM SERVICE > HTTPS**.

The **HTTPS** interface is displayed. See Figure 4-244.

Figure 4-244 HTTPS interface

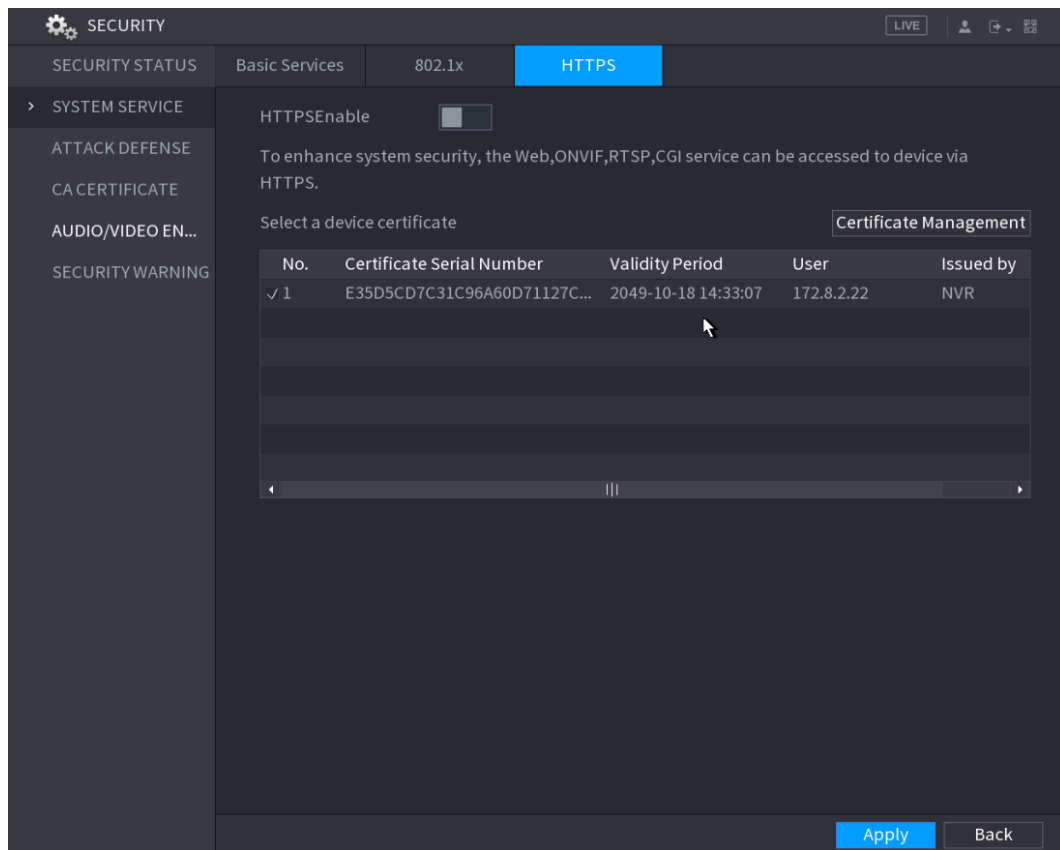

- Step 2 Select **HTTPEnable** to enable HTTPS function.
- Step 3 Click **Certificate Management** to create or import a HTTPS certificate from USB drive.
- Step 4 Select a HTTPS certificate.
- Step 5 Click **Apply** to complete the settings.

## 4.15.3 Attack Defense

### 4.15.3.1 Firewall

- Step 1 Select **Main Menu > SECURITY > ATTACK DEFENSE > Firewall**.  
The **HTTPS** interface is displayed. See Figure 4-245.



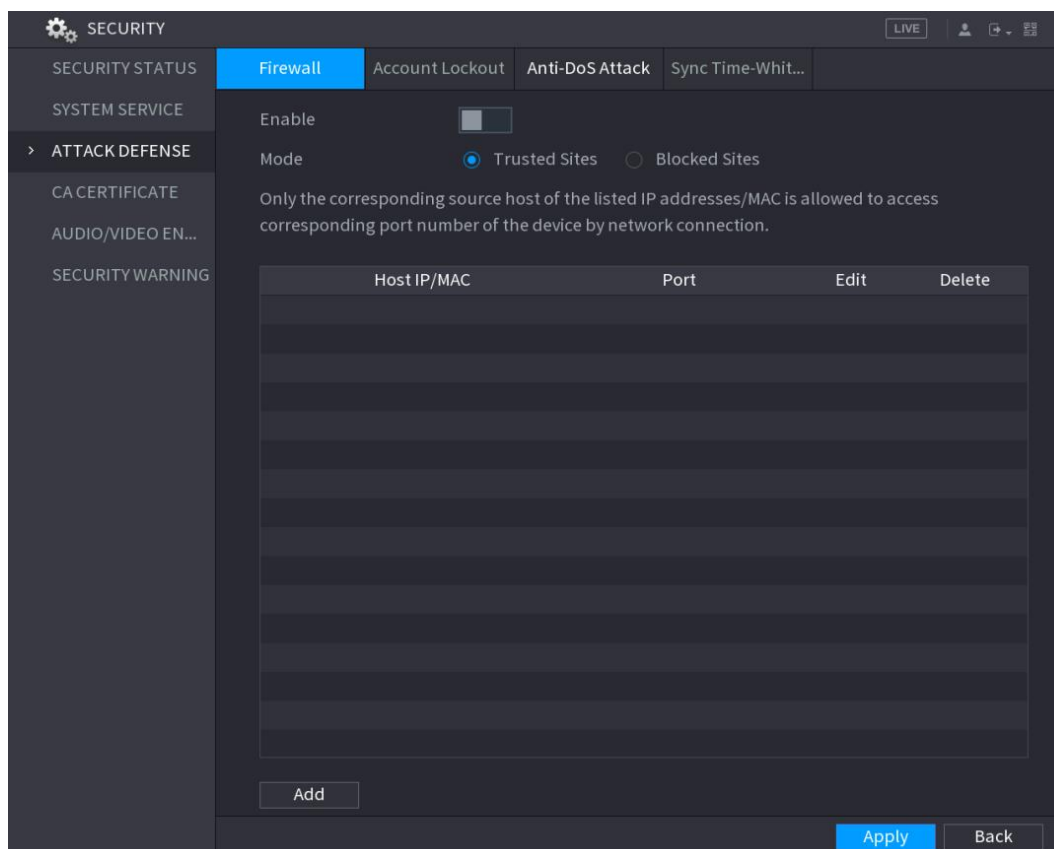

Figure 4-245 Firewall interface



**Step 2** Select **Enable** to enable firewall.

**Step 3** Configure the parameters. See Table 4-70.

Table 4-70 Firewall parameters

Parameter	Description
Mode	Mode can be configured when Type is Network Access. <ul style="list-style-type: none"> <li>If Trusted Sites is enabled, you can visit device port successfully with IP/MAC hosts in Trusted Sites.</li> <li>If Blocked Sites is enabled, you cannot visit device port with IP/MAC hosts in Blocked Sites.</li> </ul>
Add	When Type is Network Access, you can configure IP Address, IP Segment and MAC Address.
Type	You can select IP address, IP segment and MAC address.
IP Address	Enter IP Address, Start Port and End Port that is allowed or forbidden.  When Type is IP Address, they can be configured. Start Port and End Port can be configured only in Network Access Type.
Start Port	
End Port	
Start Address/End Address	Enter Start Address and End Address of IP Segment.  When Type is IP Segment, they can be configured.

Parameter	Description
MAC Address	Enter MAC Address that is allowed or forbidden  When Type is MAC Address, it can be configured.

**Step 4** Click **Apply** to complete the settings.

#### 4.15.3.2 Account Lockout

**Step 1** Select **Main Menu > SECURITY > ATTACK DEFENSE > Account Lockout**.  
The **Account Lockout** interface is displayed. See Figure 4-246.

Figure 4-246 Account Lockout

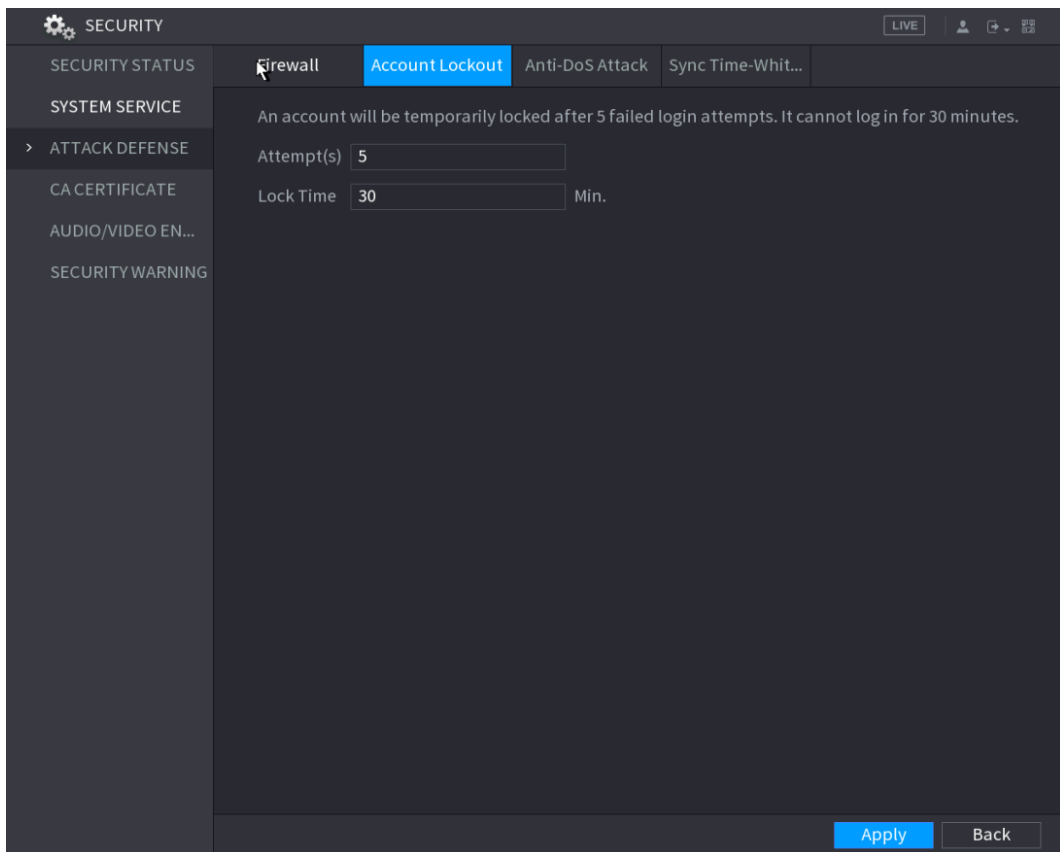

**Step 2** Set parameters. See Table 4-71.

Table 4-71 Account lockout parameters

Parameter	Description
Attempt(s)	Set the maximum number of allowable wrong password entries. The account will be locked after your entries exceed the maximum number. Value range: 5–20. Default value: 5.
Lock Time	Set how long the account is locked for. Value range: 5–120 minutes. Default value: 30 minutes.

**Step 3** Click **Apply** to complete the settings.

### 4.15.3.3 Anti-Dos Attack

You can enable **SYN Flood Attack Defense** and **ICMP Flood Attack Defense** to defend the device against Dos attack. See Figure 4-247.

Figure 4-247 Anti-Dos attack interface

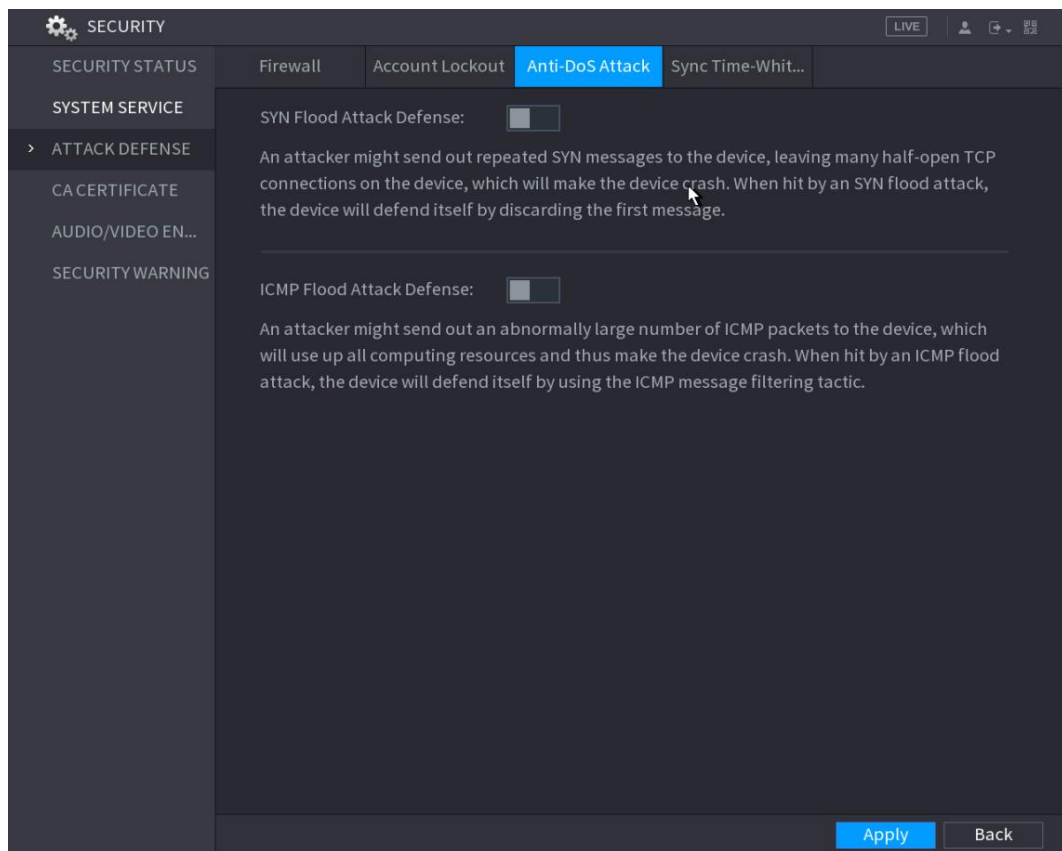

### 4.15.3.4 Sync Time-Whitelist



The synchronization is only allowed with hosts in the trusted list.

**Step 1** Select **Main Menu > SECURITY > ATTACK DEFENSE > Sync Time-Whitelist**. The **Sync Time-Whitelist** interface is displayed. See Figure 4-248.

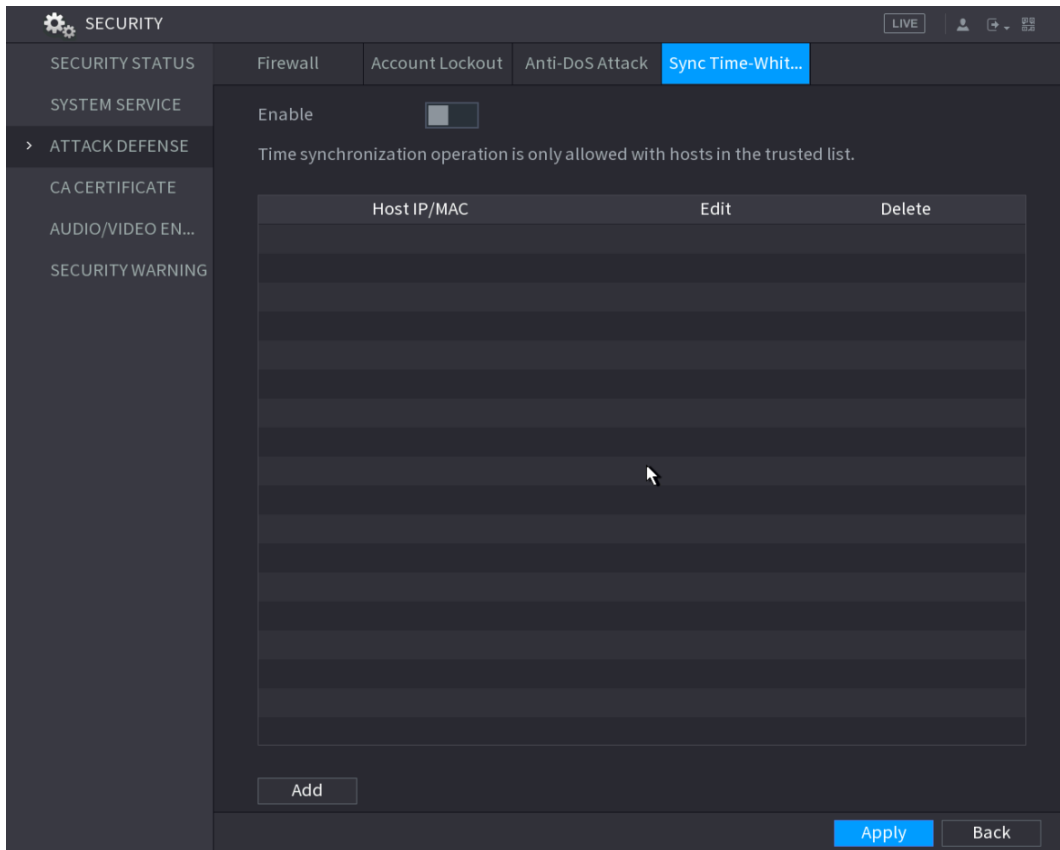

Figure 4-248 Sync Time-Whitelist



**Step 2** Select **Enable** to enable **Sync Time-Whitelist** function.

**Step 3** Configure the parameters. See Table 4-72.

Table 4-72 Sync Time-Whitelist parameters

Parameter	Description
Add	You can add trusted hosts for time synchronization.
Type	Select IP address or IP segment for hosts to be added.
IP Address	Input the IP address of a trusted host.  When Type is IP Address, it can be configured
Start Address	Input the start IP address of trusted hosts.  When Type is IP Segment, it can be configured
End Address	Input the end IP address of trusted hosts.  When Type is IP Segment, it can be configured

**Step 4** Click **Apply** to complete the settings.

## 4.15.4 CA Certificate

You can create or import device certificate and trusted CA Certificate.

### 4.15.4.1 Device Certificate

#### Create Certificate

1. Select **Main Menu > SECURITY > CA CERTIFICATE > Device Certificate**.  
The **Device Certificate** interface is displayed. See Figure 4-249.

Figure 4-249 Device Certificate

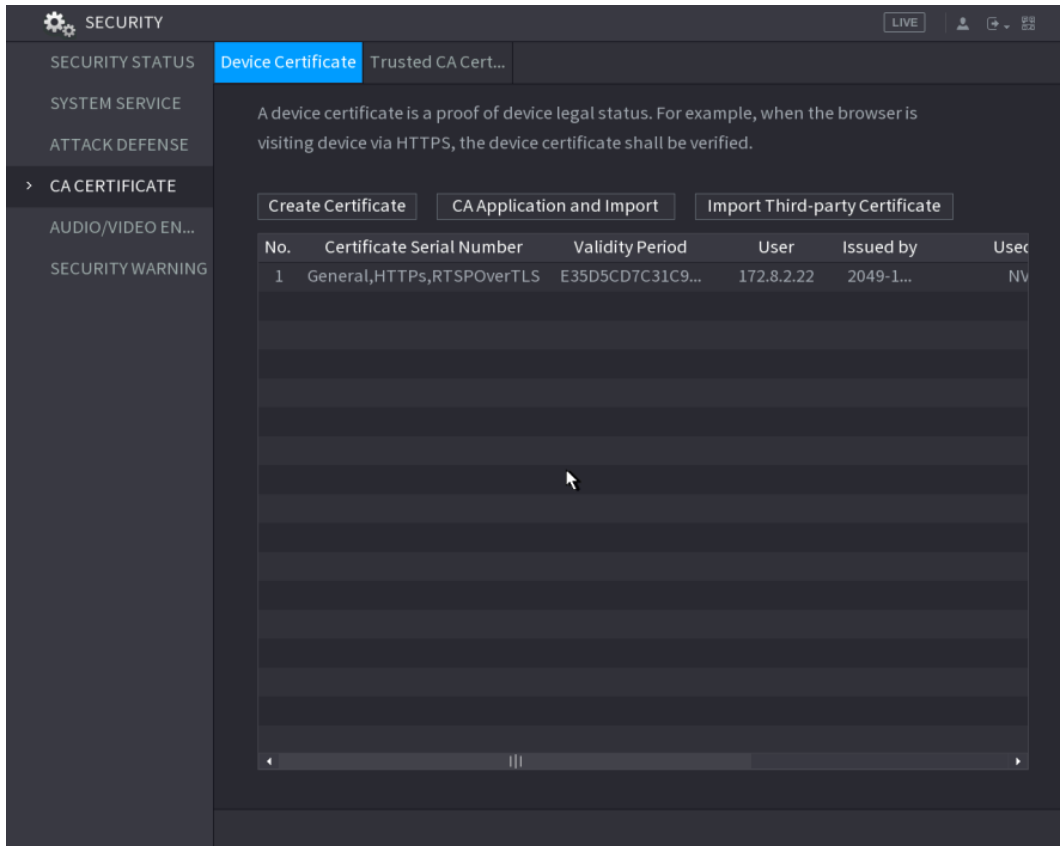

2. Configure parameters. See Table 4-73.

Table 4-73 Creating Certificate

Parameter	Description
County	This parameter is user defined.
State	This parameter is user defined.
City Name	This parameter is user defined.
Valid Period	Input a valid period for the certificate.
Organization	This parameter is user defined.
Organization Unit	This parameter is user defined.
Domain Name	Input the domain name or IP address of the certificate.

3. Click **Create**.

## CA Application and Import

Follow the on-screen instructions to finish CA application and import. See Figure 4-250.

Figure 4-250 CA application and import

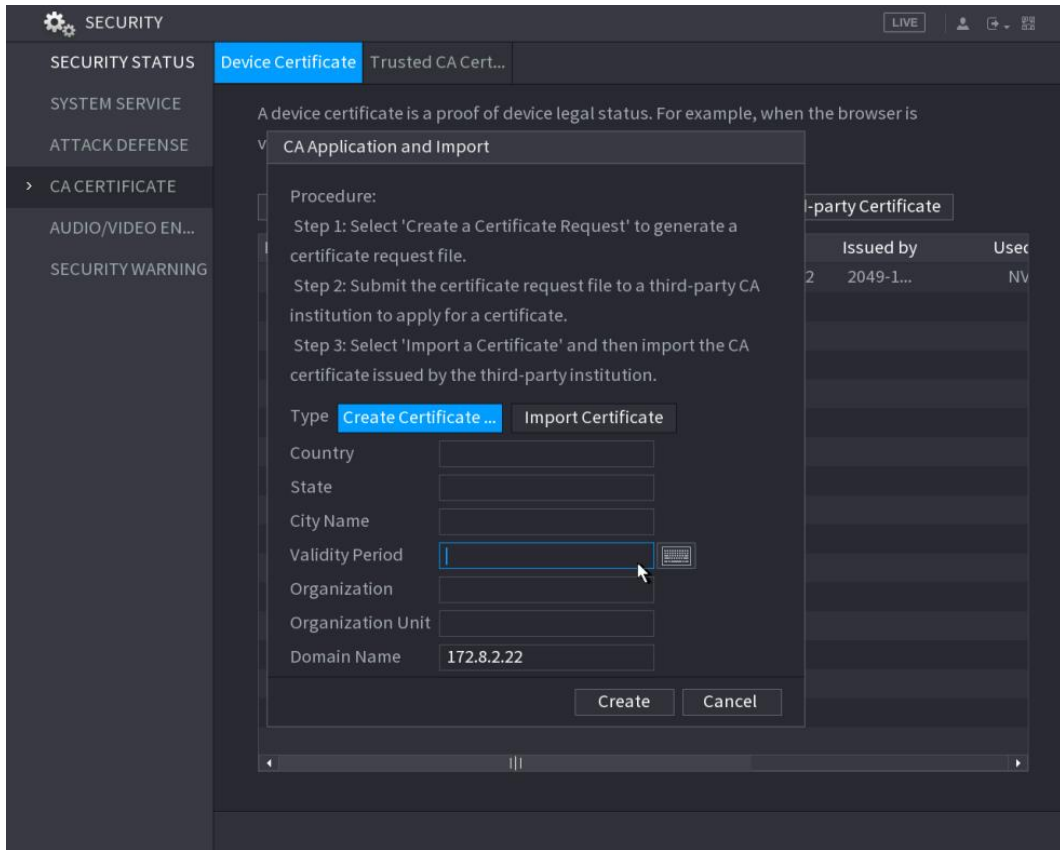

### Import Third-Party Certificate

Step 1 Configure Parameters. See Table 4-74.

Table 4-74 Importing third-party certificate

Parameter	Description
Path	Click <b>Browse</b> to find the third-party certificate path on the USB drive.
Private Key	Click <b>Browse</b> to find the third-party certificate private key on the USB drive.
Private Password	Input the private key password.

Step 2 Click **Create**.

#### 4.15.4.2 Trusted CA Certificate

Step 1 Select **Main Menu > SECURITY > CA CERTIFICATE > Trusted CA Certificate**.

Step 2 Click **Install Trusted Certificate**.

The **Create Server Certificate** is displayed. See Figure 4-251.

Figure 4-251 Creating server certificate

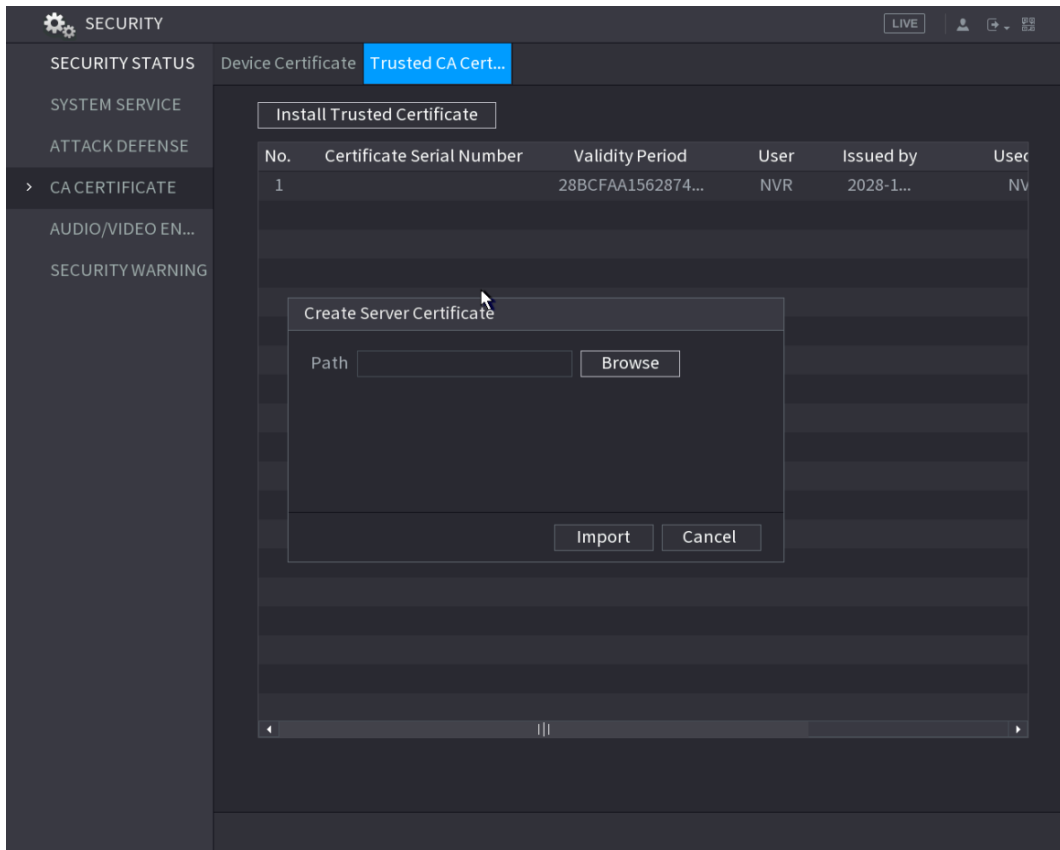

Step 3 Click **Browse** to find select the certificate that you want to install.

Step 4 Click **Import**.

### 4.15.5 Audio/Video Encryption

The device supports audio and video encryption during data transmission.

Step 1 Select **Main Menu > SECURITY > AUDIO/VIDEO ENCRYPTION > Audio/Video Transmission**.

The **Audio/Video Transmission** interface is displayed. See Figure 4-252.

Figure 4-252 Audio and video transmission

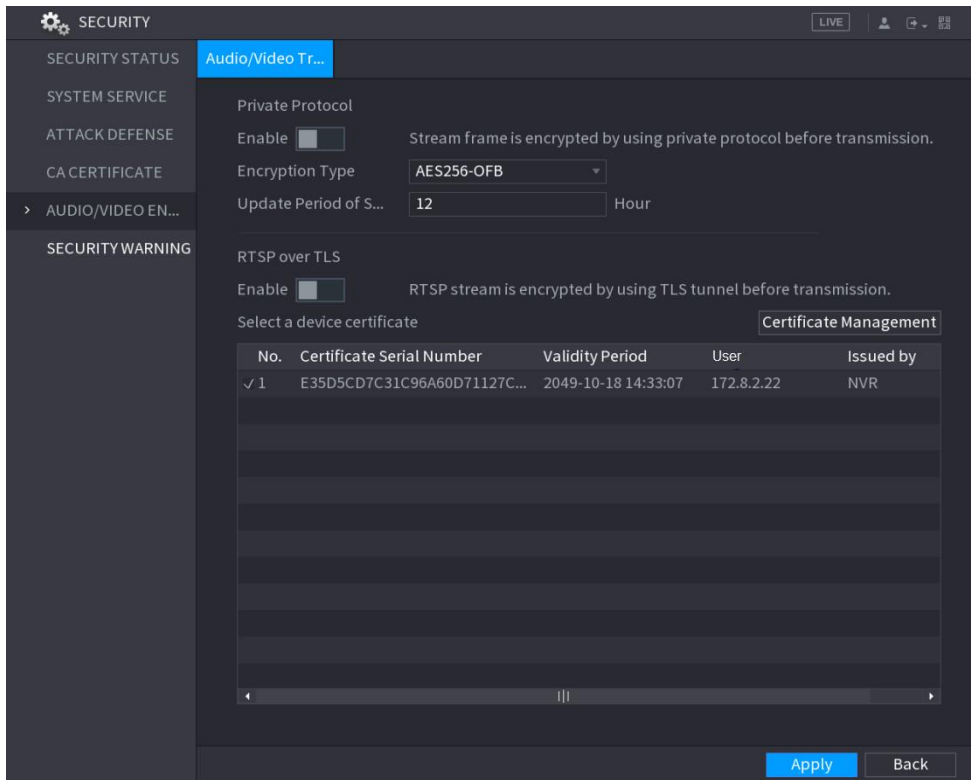

**Step 2** Configure parameters. See Table 4-75.

Table 4-75 Audio and video transmission parameters

Area	Parameter	Description
Private Protocol	Enable	Enables stream frame encryption by using private protocol. There might be safety vulnerability if this service is disabled.
	Encryption Type	Use the default setting.
	Update Period of Secret Key	Secret key update period. Value range: 0–720 hours. 0 means never update the secret key. Default value: 12.
RTSP over TLS	Enable	Enables RTSP stream encryption by using TLS. There might be safety risk if this service is disabled.
	Select device certificate	Select a device certificate for RTSP over TLS.
	Certificate Management	For details about certificate management, see "4.15.4.1 Device Certificate".

**Step 3** Click **Apply** to complete the settings.



## 4.15.6 Security Warning

### 4.15.6.1 Security Exception

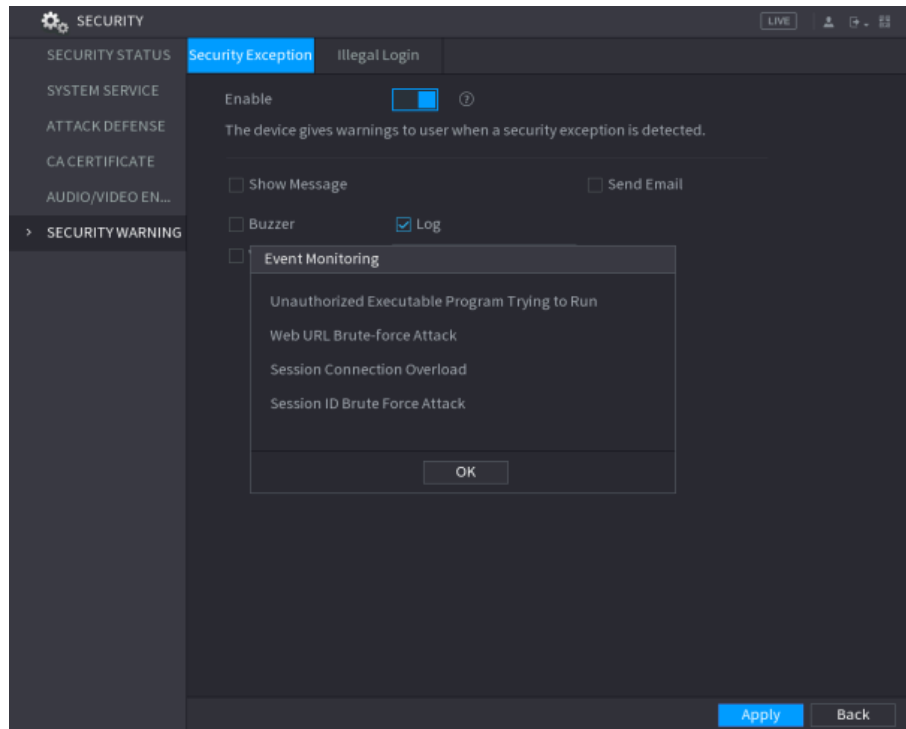

**Step 1** Select **Main Menu > SECURITY > SECURITY WARNING > Security Exception**. The **Security Exception** interface is displayed. See Figure 4-253.

Figure 4-253 Security Exception



**Step 2** Select **Enable** and configure parameters. See Table 4-76.

Table 4-76 Security exception parameters

Parameter	Description
Alarm Out	The alarm device (such as lights, sirens, etc.) is connected to the alarm output port. When an alarm occurs, the NVR device transmits the alarm information to the alarm device.
Latch	When the alarm ends, the alarm extended for a period of time. The time range is from 0 seconds to 300 seconds.
Show Message	Check box to enable a pop-up message in your local host PC.
Buzzer	Select the check box to activate the buzzer when an alarm occurs.
Voice Prompts	Check the box and then select the corresponding audio file from the dropdown list. System plays the audio file when the alarm occurs.  See "4.18.1 File Manage" to add audio file first.
Log	Select the check box, the NVR device records the alarm information in the log when an alarm occurs.
Send Email	Select the check box. When an alarm occurs, the NVR device sends an email to the set mailbox to notify the user.  You need to set the email first. For details, see "4.12.6 Email".

Parameter	Description
①	<p>Security Event monitoring explanation. It indicates the type of attacks that can trigger security exception.</p> <ul style="list-style-type: none"> <li>• Unauthorized executable program trying to run</li> <li>• Web URL brute-force attack</li> <li>• Session connection overload</li> <li>• Seesion ID brute-force attack</li> </ul>

**Step 3** Click **Apply** to complete the settings.

#### 4.15.6.2 Illegal Login

**Step 1** Select **Main Menu > SECURITY > SECURITY WARNING > Illegal Login**. The **Illegal Login** interface is displayed. See Figure 4-254.

Figure 4-254 Illegal login

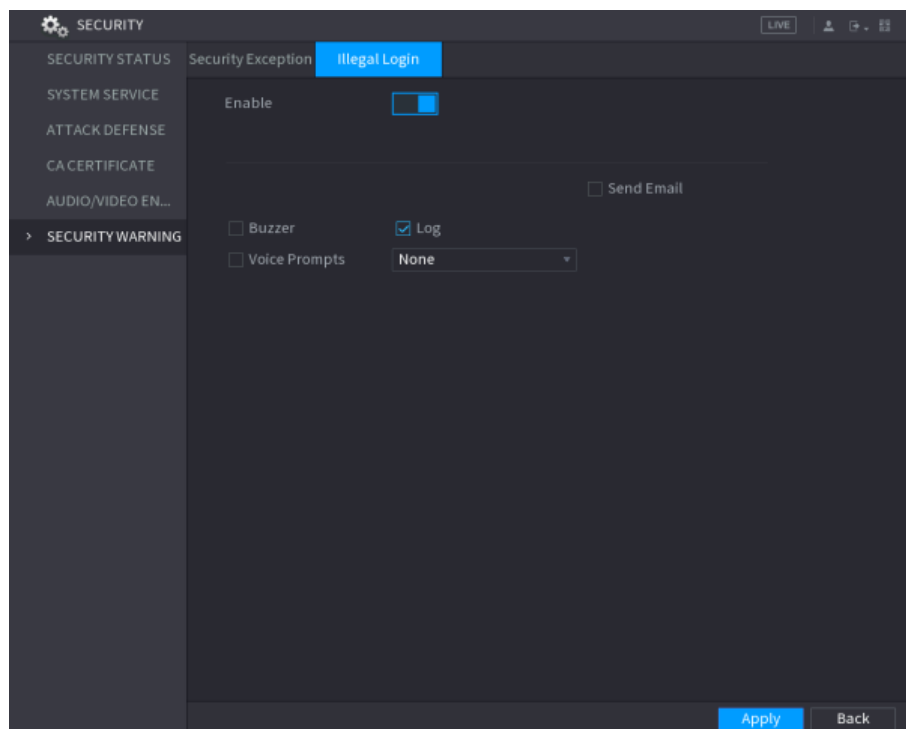

**Step 2** Select **Enable** and configure parameters. See Table 4-77.

Table 4-77 Illegal login parameters

Parameter	Description
Alarm Out	The alarm device (such as lights, sirens) is connected to the alarm output port. When an alarm occurs, the NVR device transmits the alarm information to the alarm device.
Latch	When the alarm ends, the alarm extended for a period of time. The time range is from 0 seconds to 300 seconds.
Buzzer	Select the check box to activate the buzzer when an alarm occurs.
Voice Prompts	<p>Check the box and then select the corresponding audio file from the dropdown list. System plays the audio file when the alarm occurs.</p> <p> See "4.18.1 File Manage" to add audio file first.</p>

Parameter	Description
Log	Select the check box, the NVR device records the alarm information in the log when an alarm occurs.
Send Email	Select the check box. When an alarm occurs, the NVR device sends an email to the set mailbox to notify the user.  You need to set the email first. For details, see "4.12.8 Email".



Figure 4-256

**Step 3** Input the user name, password, select the group it belongs to from the dropdown list. Then you can check the corresponding rights for current user. See Table 4-78.

Table 4-78

Parameter	Description
User Name	Enter a user name and password for the account.
Password	
Confirm Password	Re-enter the password.
Memo	Optional. Enter a description of the account.
User MAC	Enter user MAC address
Group	Select a group for the account.  The user rights must be within the group permission.
Period	Click <b>Set</b> to display <b>Set</b> interface. Define a period during which the new account can login the device. The new account cannot login the device during the time beyond the set period.
Authority	In the <b>Authority</b> area, select the check boxes in the <b>System</b> tab, <b>Playback</b> tab, and <b>Monitor</b> tab.  To manage the user account easily, when defining the user account authority, it is recommended not to give the authority to the common user account higher than the advanced user account.

**Step 4** Click **OK** button.



Click to modify the corresponding user information, click to delete the user.

#### 4.16.1.2 Modify Password

**Step 1** Select **Main Menu > ACCOUNT > User**, click  of the corresponding user.

The **Modify User** interface is displayed. See Figure 4-257.

Figure 4-257

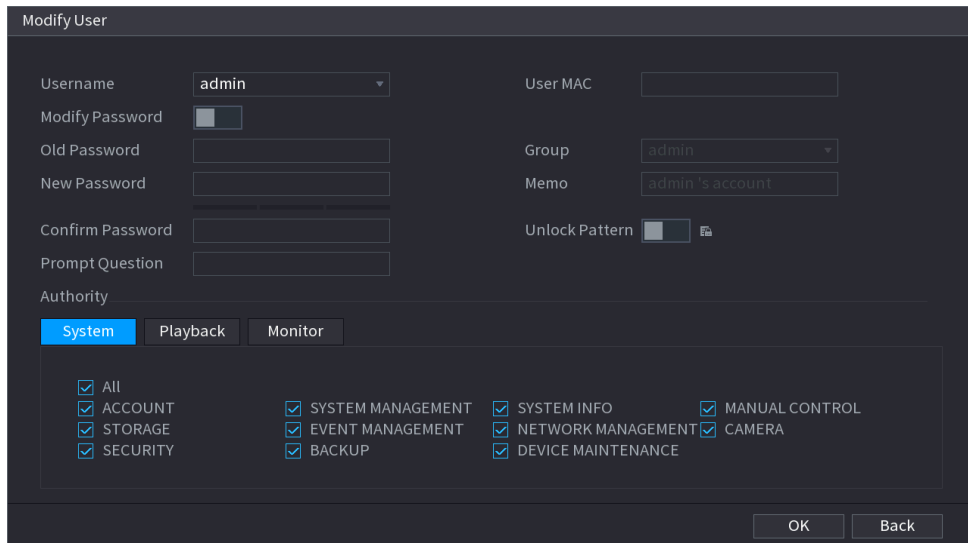

**Step 2** Check the box to enable **Modify Password** function. Enter old password and then enter new password twice.



- Password/confirm password: The password ranges from 8 to 32 digitals. It can contain letters, numbers and special characters (excluding “”, “”, “”, “”, “”, “&”) . The password shall contain at least two categories. Usually we recommend the strong password.
- For the user of account authority, it can modify the password of other user.
- **STRONG PASSWORD RECOMMENDED**-For your device own safety, create a strong password of your own choosing. We also recommend you change your password periodically especially in the high security system.
- Check the box to enable Unlock Pattern function, click .

**Step 3** Enter the **Unlock Pattern** interface to set. See Figure 4-258.

Figure 4-258

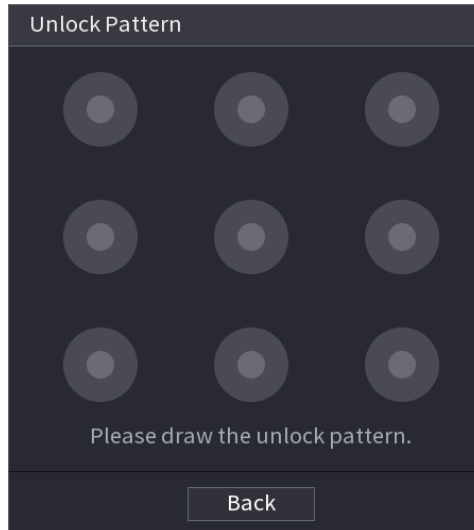

Step 4 Click **Back**.

#### 4.16.2 Group

Step 1 Select **Main Menu > ACCOUNT > Group**.

The **Group** interface is displayed. See Figure 4-259.

Figure 4-259

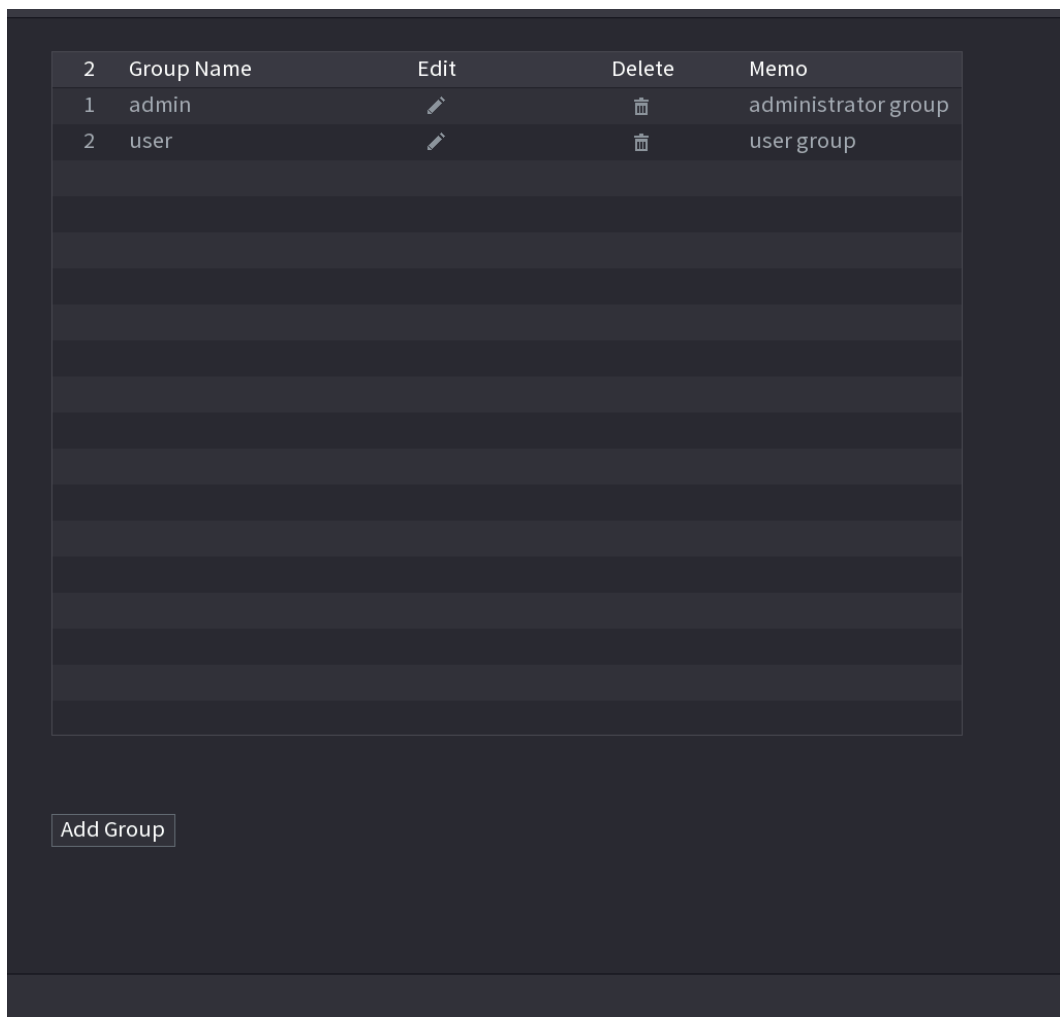

Step 2 Click **Add Group** button in Figure 4-259.

The **Add Group** interface is displayed. See Figure 4-260.

**Step 3** Enter group name and then input some memo information if necessary. Check the box to select authorities.



Figure 4-260

The screenshot shows the 'Add Group' interface. It features a dark theme with the following elements:

- Title:** Add Group
- Inputs:** Two text input fields for 'Group Name' and 'Memo'.
- Authority Selection:** Three tabs labeled 'System', 'Playback', and 'Monitor'. The 'System' tab is currently selected.
- Checkboxes:** A grid of checkboxes for selecting authorities:
  - Row 1:  All,  ACCOUNT,  SYSTEM MANAGEMENT,  SYSTEM INFO,  MANUAL CONTROL
  - Row 2:  STORAGE,  EVENT MANAGEMENT,  NETWORK MANAGEMENT,  CAMERA
  - Row 3:  SECURITY,  BACKUP,  DEVICE MAINTENANCE
- Buttons:** 'OK' and 'Back' buttons at the bottom right.

**Step 4** Click **OK**.



Click  to modify the corresponding group information, click  to delete the group.

### 4.16.3 Reset Password

You can set security questions and answers. After you successfully answered security questions, you can reset admin account password.



This function is for **admin** user only.

**Step 1** Select **Main Menu > ACCOUNT > PASSWORD RESET**.

The **PASSWORD RESET** interface is displayed. See Figure 4-261.



Figure 4-261

Reset Password

Enable

Email Address

Security Question

Please set a security question so that you can find the password of admin again.

Question 1

Answer

Question 2

Answer

Question 3

Answer

Apply Back

**Step 2** Check the box to enable Reset password function.



This function is enabled by default.

**Step 3** Input proper security questions and answers.

**Step 4** Click **OK**.

After you successfully set security questions, you can answer the security questions to reset **admin** password.

#### 4.16.4 ONVIF User

When the camera from the third party is connected with the NVR via the ONVIF user, use the verified ONVIF account to connect to the NVR. Here you can add/delete/modify user



- The default ONVIF user is **admin**. It is created after you initialize the NVR.
- For some series product, the ONVIF user password is modified when you are initializing the admin password.

**Step 1** Select **Main Menu > ACCOUNT > ONVIF User**.

The **ONVIF User** interface is displayed. See Figure 4-262.

Figure 4-262

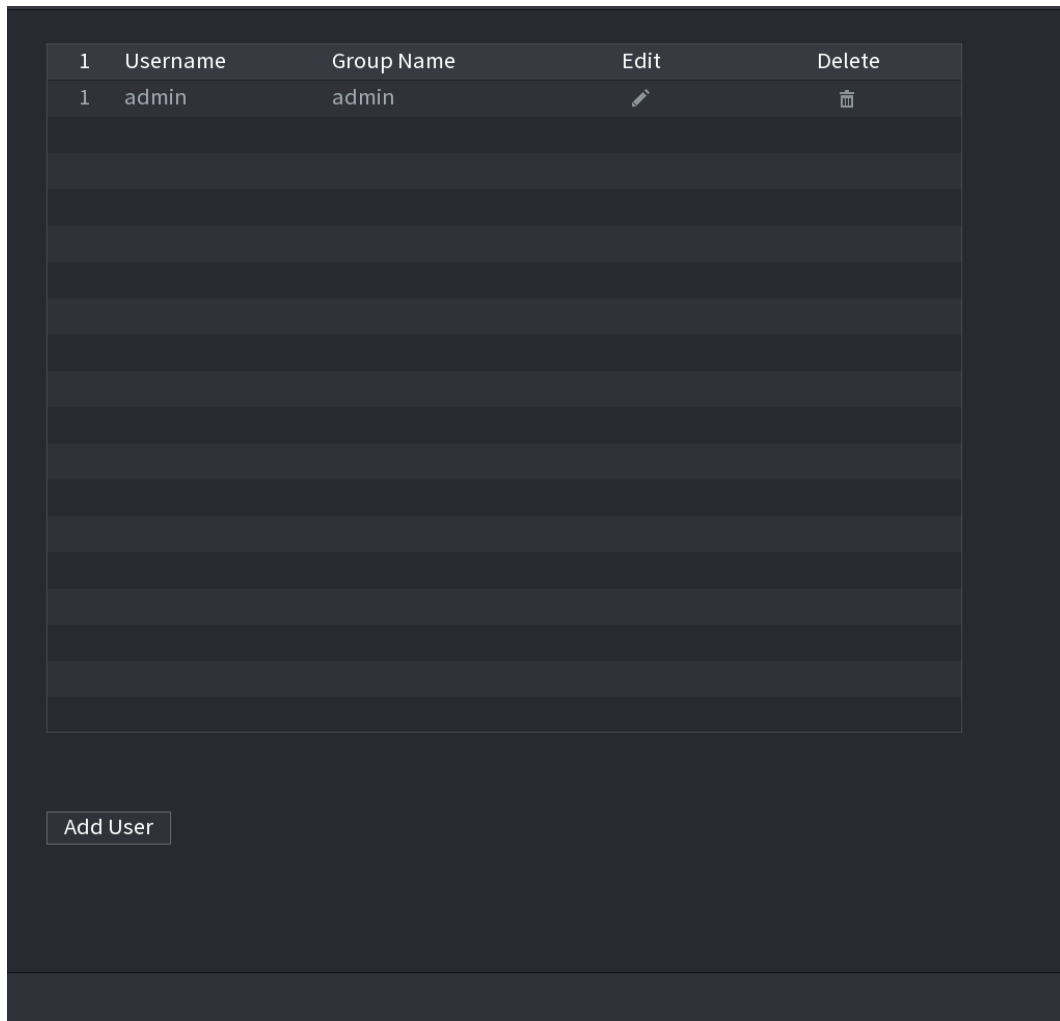

**Step 2** Click **Add User** button.

The **Add User** interface is displayed. See Figure 4-263.

Figure 4-263

Add User

Username

Password

Confirm Password



Group

OK Back

**Step 3** Set user name, password and then select group from the dropdown list.

**Step 4** Click **OK** to complete setup.



Click  to modify corresponding user information, click  to delete current user.

## 4.17 Output and Display

### 4.17.1 Display

You can configure the display effect such as displaying time title and channel title, adjusting image transparency, and selecting the resolution.

**Step 1** Select **Main Menu > DISPLAY > Display**.

The **Display** interface is displayed. See Figure 4-264.

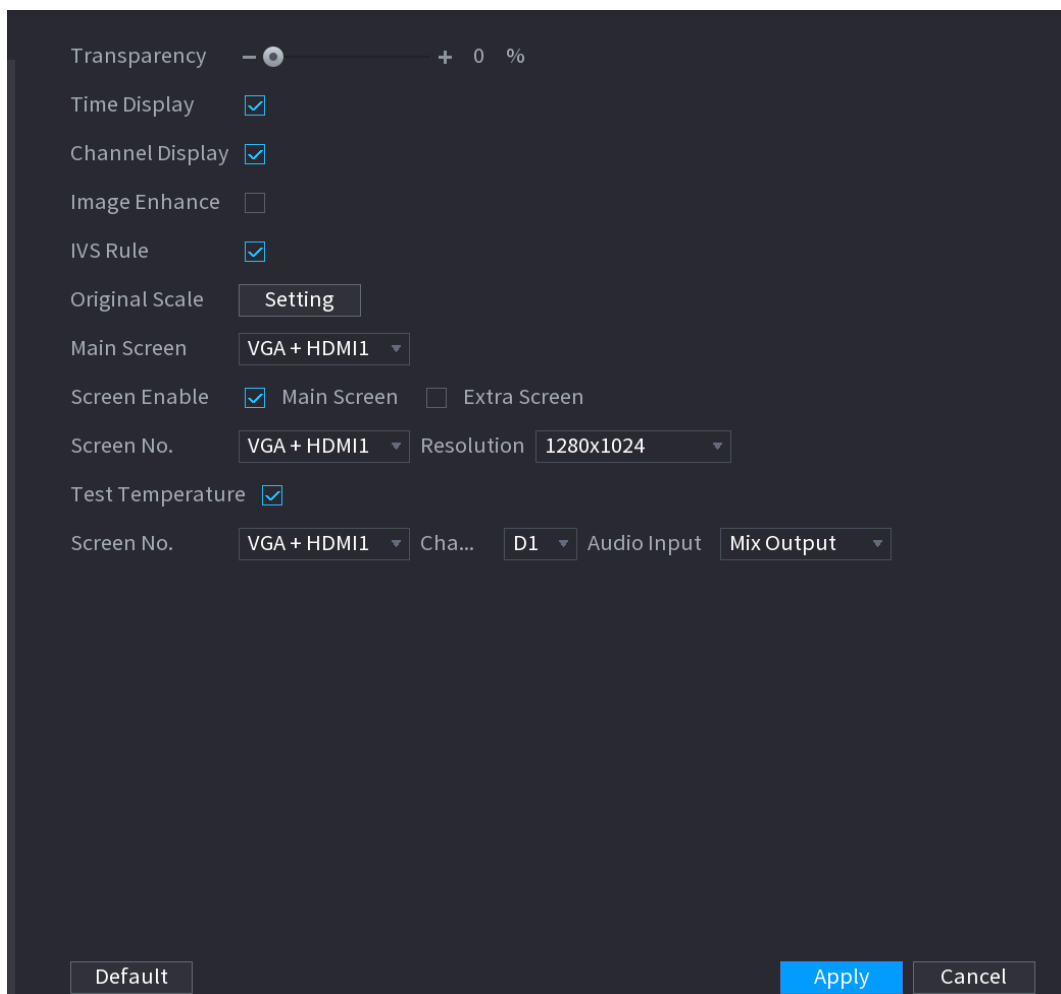

Figure 4-264



**Step 2** Configure the settings for the display parameters. See Table 4-79.

Table 4-79

Parameter	Description
Transparency	Set the transparency of the local menu of the NVR device. The higher the transparency, the more transparent the local menu.
Time Display/Channel Display	Select the check box and the date and time of the system will be displayed in the preview screen.
Image Enhance	Select the check box to optimize the preview image edges.

Parameter	Description
IVS Rule	Select the check box to display the IVS rules in the preview interface.  This function is for some series products only.
Original Scale	Click <b>Setting</b> and select the channel to restore the corresponding channel image to the original scale.
Main Screen	Select VGA+HDMI1 or HDMI2.  Different devices display different contents. See the actual situation.
Screen Enable	Select the check box to enable this screen. The image can only be displayed when the screen is enabled.
Test Temperature	Check the box to test the object temperature, including trace the high/low temperature.
Resolution	Support 1920×1080, 1280×1024(default), 1280×720.
Screen No.	Enter the screen number you want to set the audio input.
Channel	Select the channel number.
Audio Input	Select from audio 1, audio 2 and mix output.

Step 3 Click **Apply**.

#### 4.17.2 Tour



You can configure a tour of selected channels to repeat playing videos. The videos display in turn according to the channel group configured in tour settings. The system displays one channel group for a certain period and then automatically changes to the next channel group.



Step 1 Select **Main Menu > DISPLAY > Tour**.

The **Tour** interface is displayed. See Figure 4-265.

Figure 4-265



On the top right of the live view screen, use the left mouse button or press Shift to switch between  (image switching is allowed) and  (image switching is not allowed) to turn on/off the tour function.

On the navigation bar, click  to enable the tour and click  to disable it.

**Step 2** Configure the settings for the tour parameters. See Table 4-80.

Table 4-80

Parameter	Description
Enable	Enable tour function.
Interval (Sec.)	Enter the amount of time that you want each channel group displays on the screen. The value ranges from 5 seconds to 120 seconds, and the default value is 5 seconds.
Video Detect, Alarm	Select the View 1 or View 8 for <b>Motion Detect</b> tour and <b>Alarm</b> Tour (system alarm events).
Window Split	In the <b>Window Split</b> list, select <b>View 1</b> , <b>View 4</b> , <b>View 8</b> , or other modes that are supported by the Device.
Channel Group	Display all channel groups under the current Window Split setting.

Parameter	Description
	<ul style="list-style-type: none"> <li>• Add a channel group: Click <b>Add</b>, in the pop-up <b>Add Group</b> channel, select the channels to form a group, and then click <b>Save</b>.</li> <li>• Delete a channel group: Select the check box of any channel group, and then click <b>Delete</b>.</li> <li>• Edit a channel group: Select the check box of any channel group and then click <b>Modify</b>, or double-click on the group. The <b>Modify Channel Group</b> dialog box is displayed. You can regroup the channels.</li> <li>• Click <b>Move up</b> or <b>Move down</b> to adjust the position of channel group.</li> </ul>

Step 3 Click **Apply** to save the settings.

### 4.17.3 Customized Display

You can set customized video split mode.



- This function is for some series products. Refer to the actual product for detailed information.
- Device max. supports 5 customized videos.

Step 1 Select **Main Menu > DISPLAY > Custom Split**.

The **Custom Split** interface is displayed. See Figure 4-266.

Figure 4-266

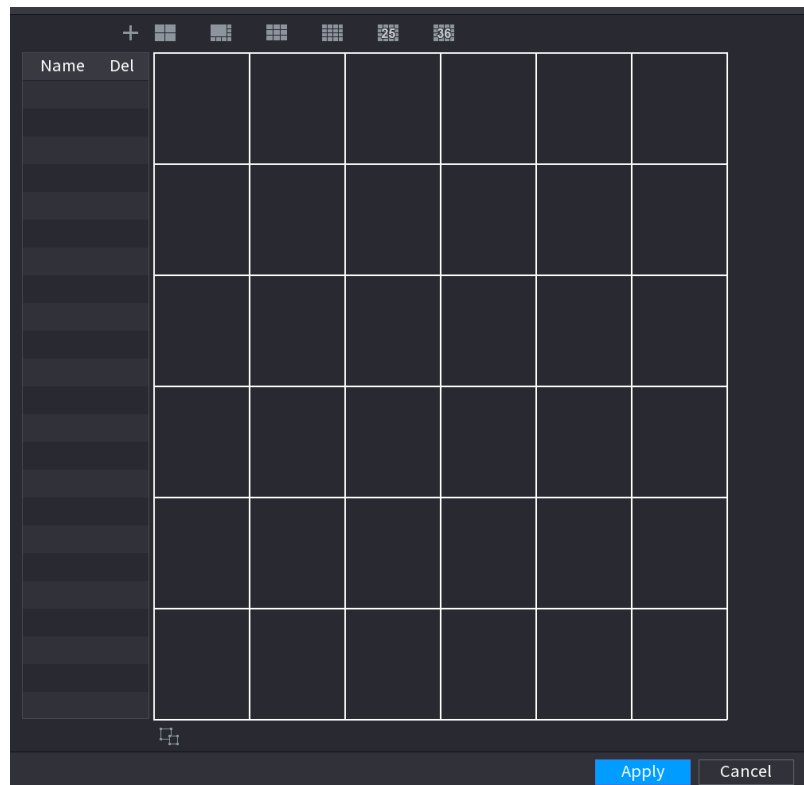

Step 2 Click  and then click  to select basic mode.

System adopts the basic window mode as the new window name. For example, if you select the 8 display mode, the default name is Split8.

In regular mode, drag the mouse in the preview frame; you can merge several small windows to one window so that you can get you desired split mode. See Figure 4-267.





- After merge the window, system adopts the remaining window amount as the new name such as Split6.
- Select the window you want to merge (red highlighted), click  to cancel the merge to restore the basic mode.
- Click  to delete the customized window mode.

Figure 4-267



**Step 3** Click **Apply** to exit.

After the setup, you can go to the preview window, right click mouse and then select **Custom Split**. See Figure 4-268.

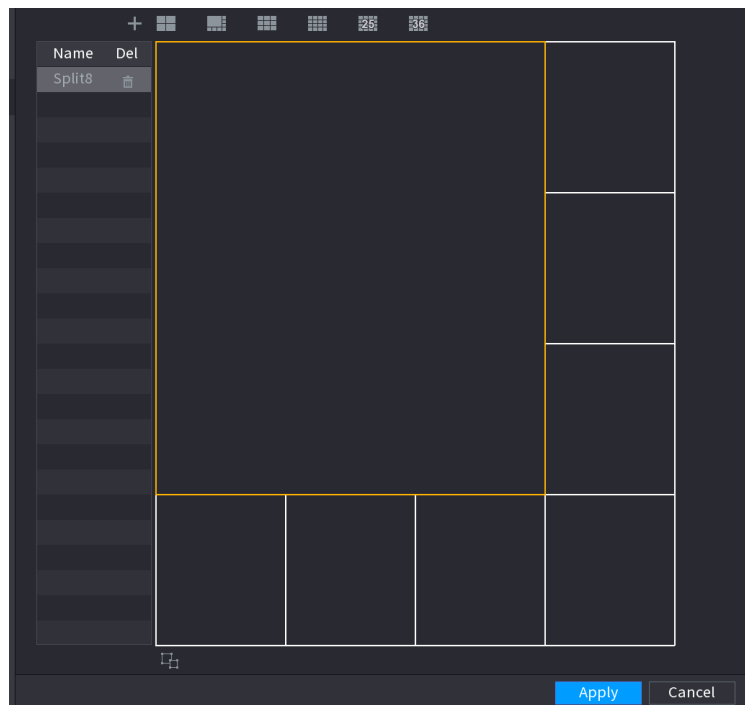
Figure 4-268

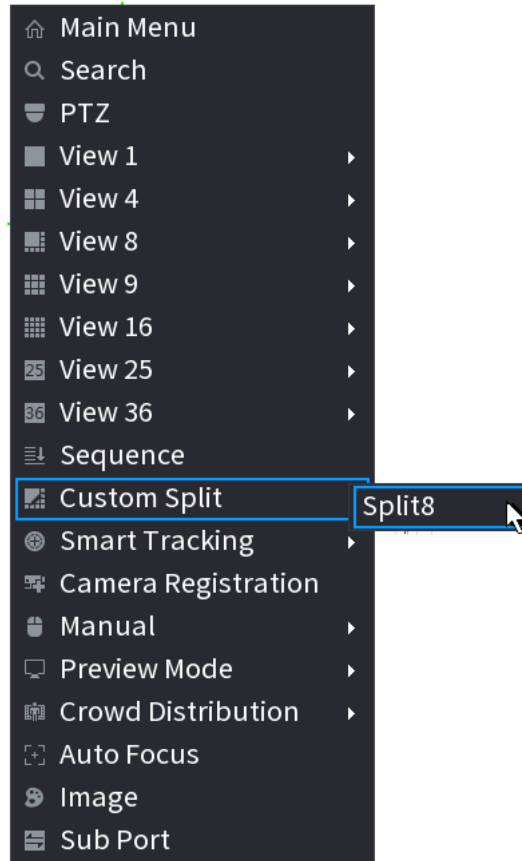

## 4.18 Audio

The audio function is to manage audio files and set schedule play function. It is to realize audio broadcast activation function.



This function is for some series product only.

### 4.18.1 File Manage

You can add audio files, listen to audio files, rename and delete audio files, and configure the audio volume.

**Step 1** Select **Main Menu > AUDIO > File Manager**.

The **File Manager** interface is displayed. See Figure 4-269.



Figure 4-269

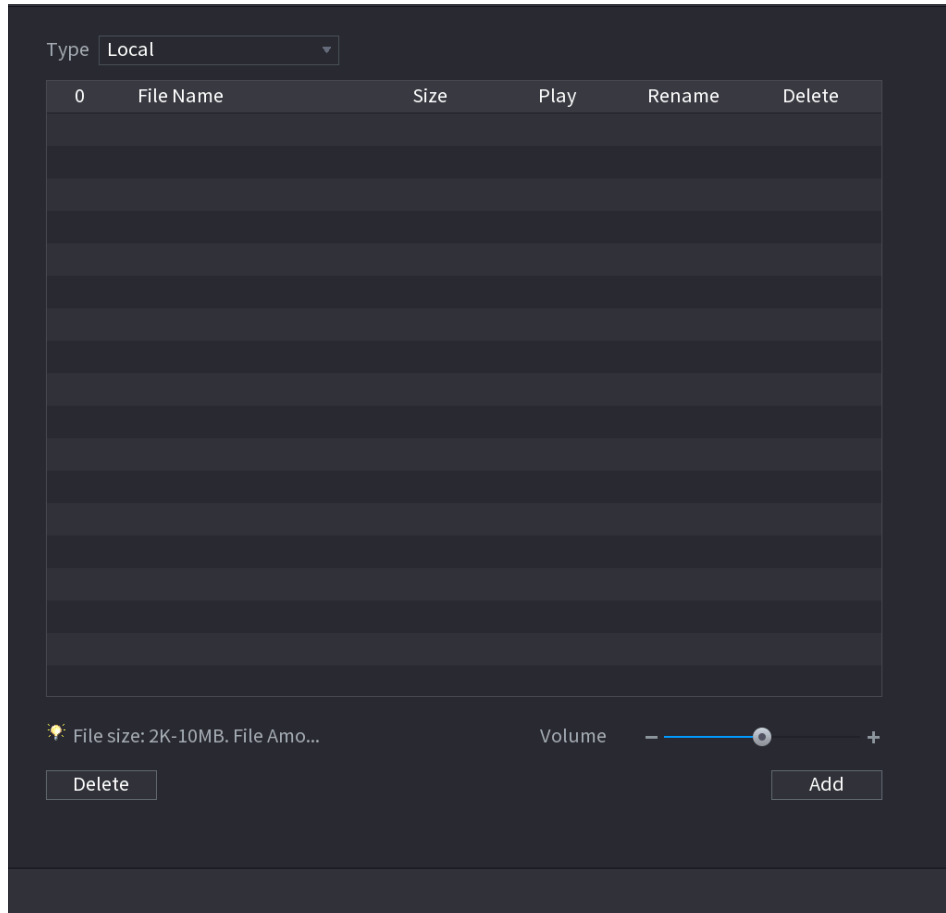

**Step 2** Click **Add**.

The **Add** interface is displayed. See Figure 4-270.



NVR supports USB port to import audio file only.

Figure 4-270

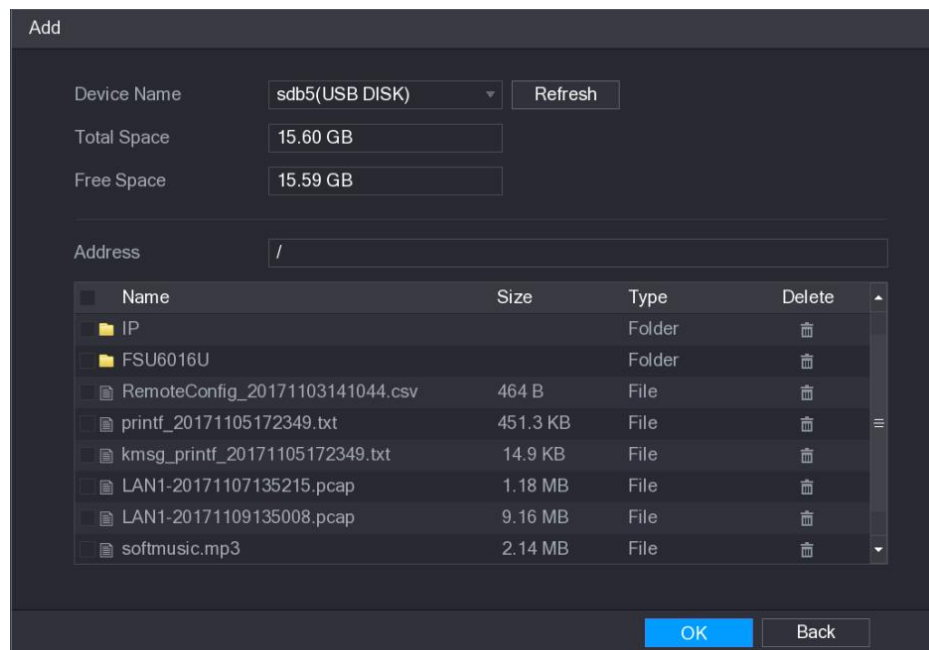

**Step 3** Select the audio file and then click **Import**.

System supports MP3 and PCM audio format.

Step 4 Click **OK** to start importing audio files from the USB storage device.

If the importing is successful, the audio files will display in the **File Manager** interface.

#### 4.18.2 Schedule

You can configure the settings to play the audio files during the defined time period.

Step 1 Select **Main Menu > AUDIO > Schedule**.

The **Schedule** interface is displayed. See Figure 4-271.

Figure 4-271

Period	File Name	Interval	Repeat	Output
<input type="checkbox"/> 00 : 00 - 24 : 00	None	60 Min.	0	Mic
<input type="checkbox"/> 00 : 00 - 24 : 00	None	60 Min.	0	Mic
<input type="checkbox"/> 00 : 00 - 24 : 00	None	60 Min.	0	Mic
<input type="checkbox"/> 00 : 00 - 24 : 00	None	60 Min.	0	Mic
<input type="checkbox"/> 00 : 00 - 24 : 00	None	60 Min.	0	Mic
<input type="checkbox"/> 00 : 00 - 24 : 00	None	60 Min.	0	Mic

Apply Back

Step 2 Configure the settings for the schedule parameters. See Table 4-81.

Table 4-81

Parameter	Description
Period	In the <b>Period</b> box, enter the time. Select the check box to enable the settings. You can configure up to six periods.
File Name	In the <b>File Name</b> list, select the audio file that you want to play for this configured period.
Interval	In the <b>Interval</b> box, enter the time in minutes for how often you want to repeat the playing.
Repeat	Configure how many times you want to repeat the playing in the defined period.

Parameter	Description
Output	Includes two options: MIC and Audio. It is MIC by default. The MIC function shares the same port with talkback function and the latter has the priority.  Some series products do not have audio port. The actual product shall prevail.



- The finish time for audio playing depends on audio file size and the configured interval.
- Playing priority: Alarm event > Audio talk > Trial listening > Schedule audio file.

Step 3 Click **Apply** to complete the settings.

### 4.18.3 Broadcast

System can broadcast to the camera, or broadcast to a channel group.

Step 1 Select **Mani Menu > AUDIO > BROADCAST**.

The **BROADCAST** interface is displayed. See Figure 4-272.

Figure 4-272

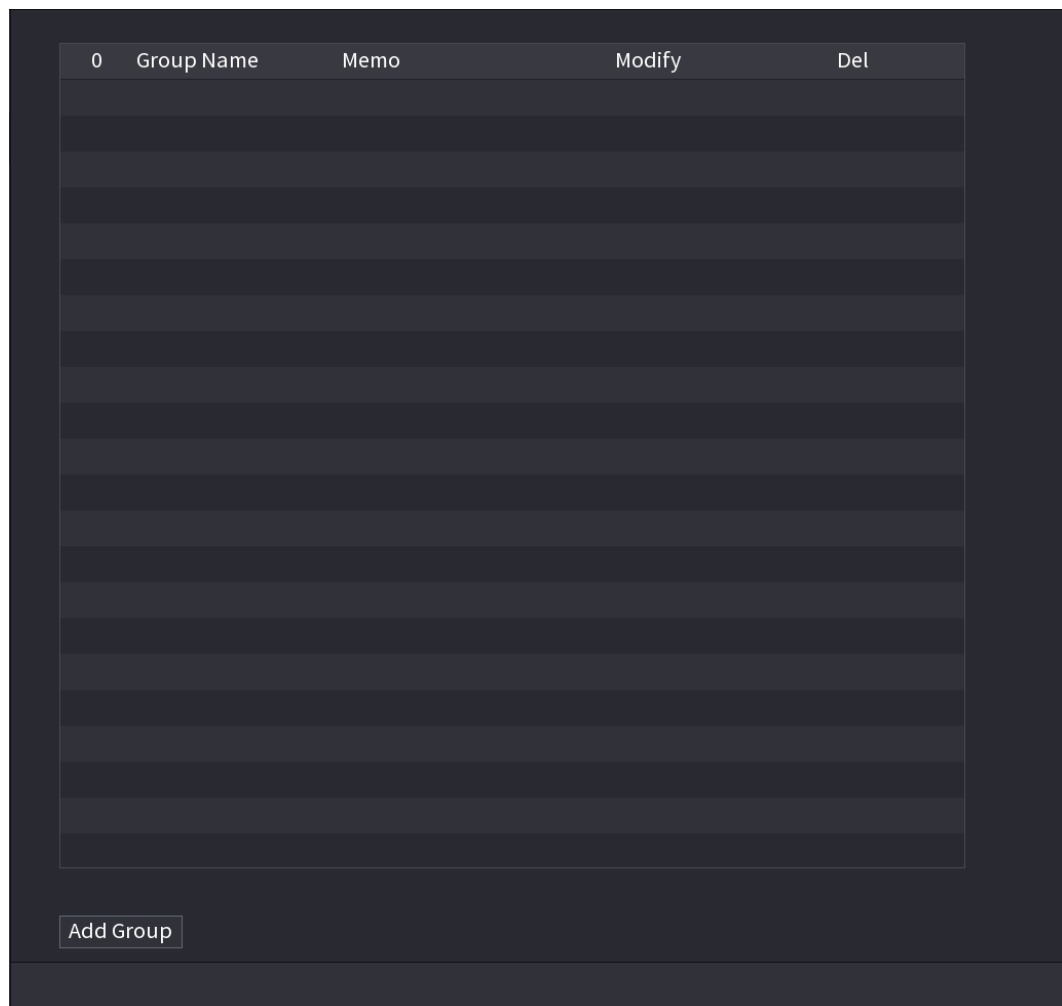

Step 2 Click **Add Group**.

The **Add Group** interface is displayed. See Figure 4-273.

Figure 4-273

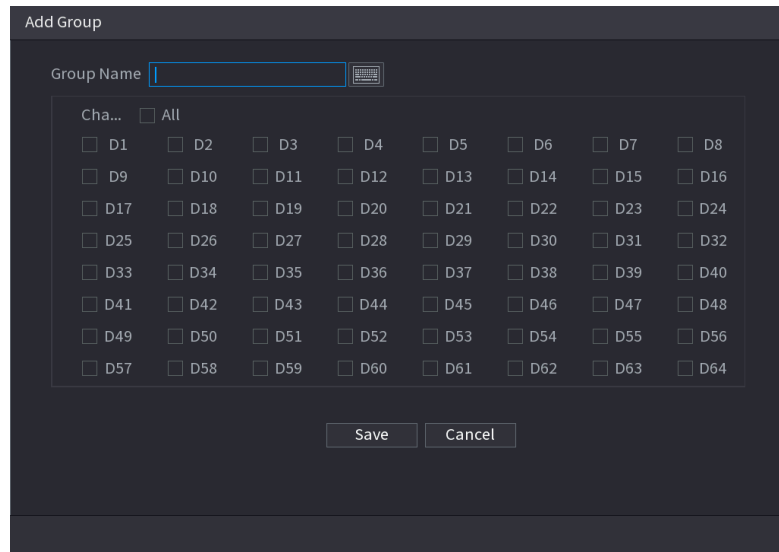

Step 3 Input group name and select one or more channels.

Step 4 Click **Save** button to complete broadcast group setup.







- On the broadcast interface, click  to change group setup, click  to delete group.
- After complete broadcast setup, on the preview interface and then click  on the navigation bar, device pops up broadcast dialogue box. Select a group name and then click  to begin broadcast. See Figure 4-274.

Figure 4-274



### 4.19 USB Device Auto Pop-up

After you inserted the USB device, system can auto detect it and pop up the following dialogue box. It allows you to conveniently backup file, log, configuration or update system. See Figure 4-275.

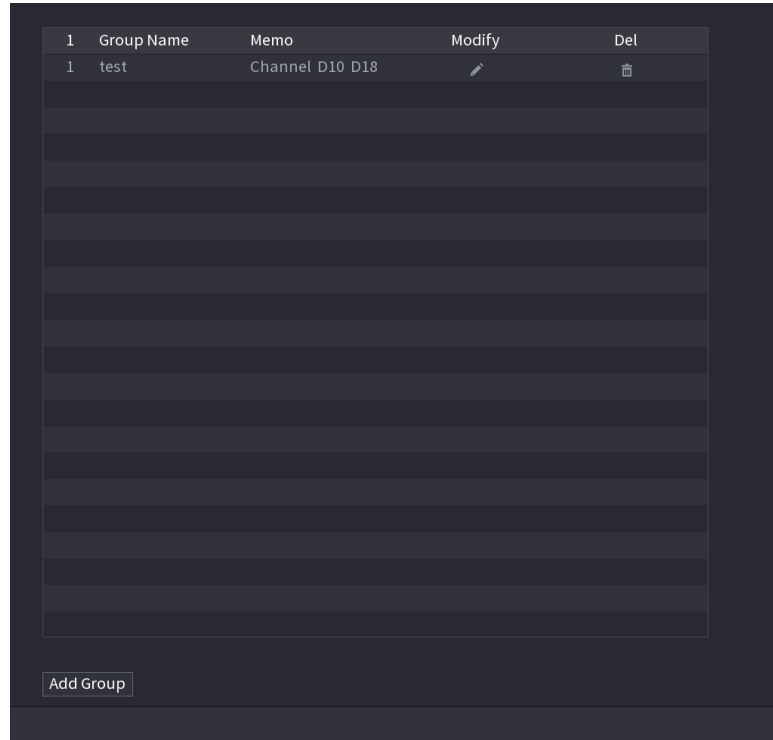
Refer to "4.18.1 File Manage", "4.10.1 Log", "4.10.4.2 IMP/EXP", and "4.10.4.4 System Update" for detailed information.

Figure 4-275

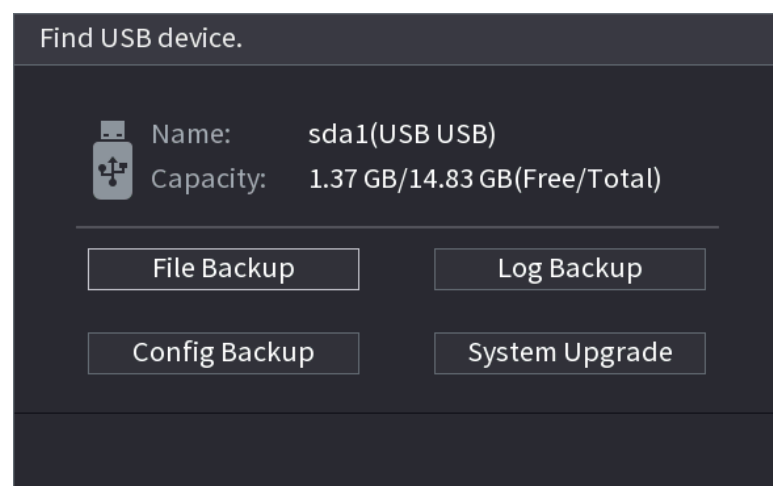

### 4.20 Shutdown



- When you see corresponding dialogue box "System is shutting down..." Do not click power on-off button directly.
- Do not unplug the power cable or click power on-off button to shutdown device directly when device is running (especially when it is recording.)
- Shut down the device and then unplug the power cable before you replace the HDD.

## Operations

- From the main menu (Recommended)

Step 1 Click  at the top right corner. See Figure 4-276.

Figure 4-276

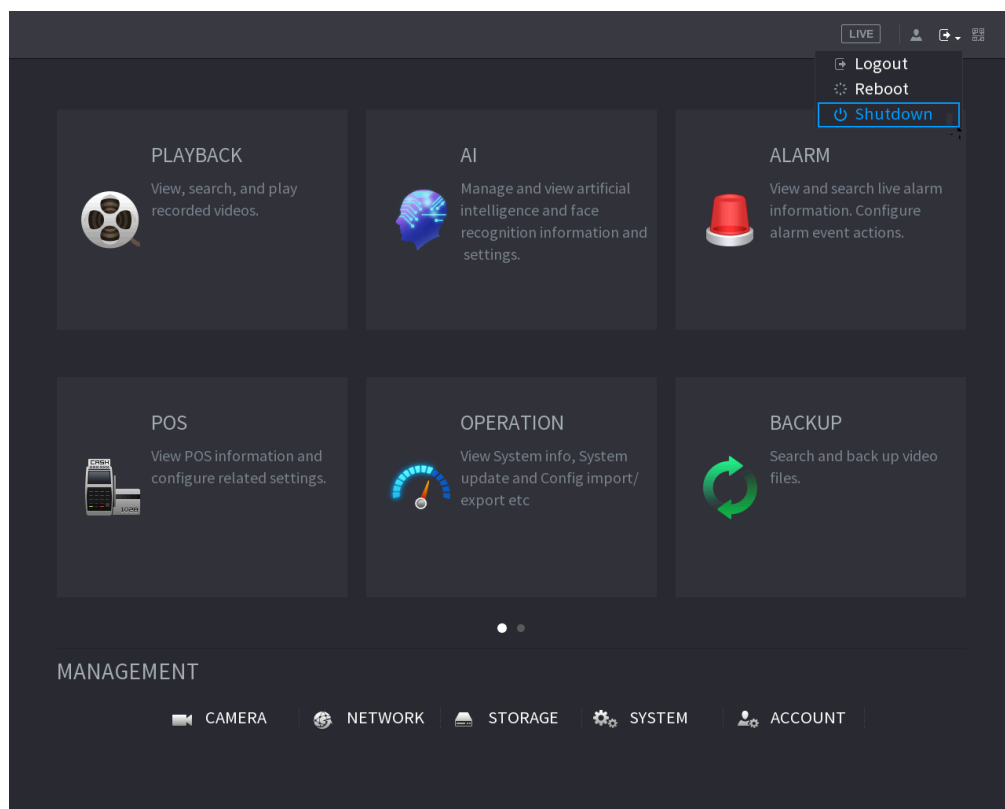

Step 2 Select **Shutdown**.

Draw the unlock pattern or input password first if you have no authority to shut down. See Figure 4-277 or Figure 4-278.

Figure 4-277

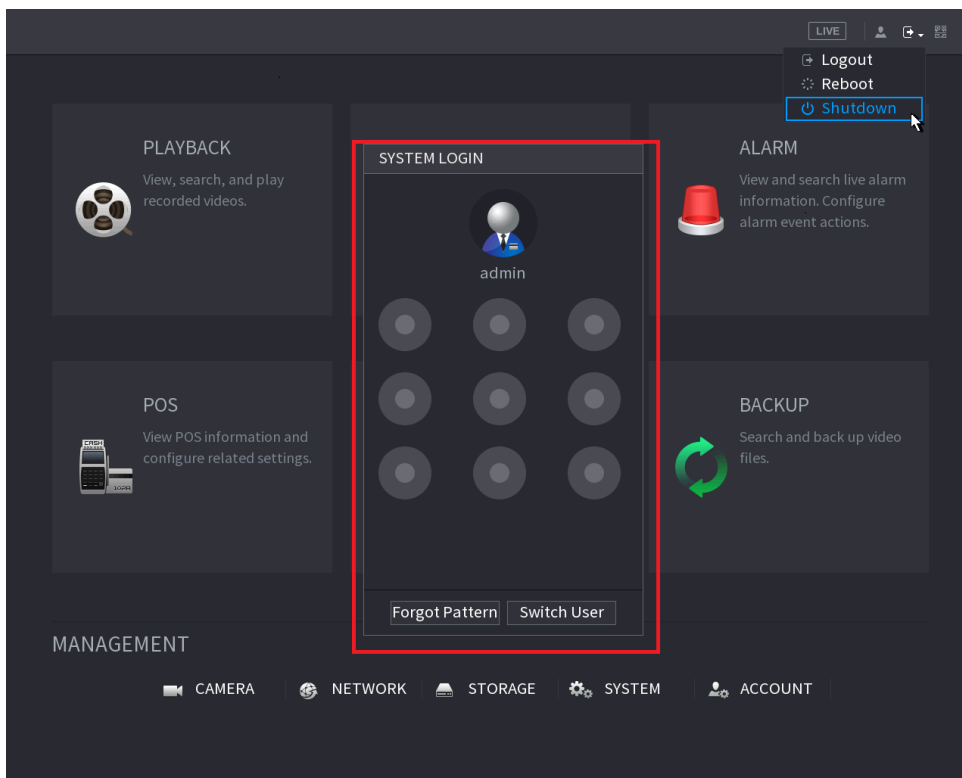
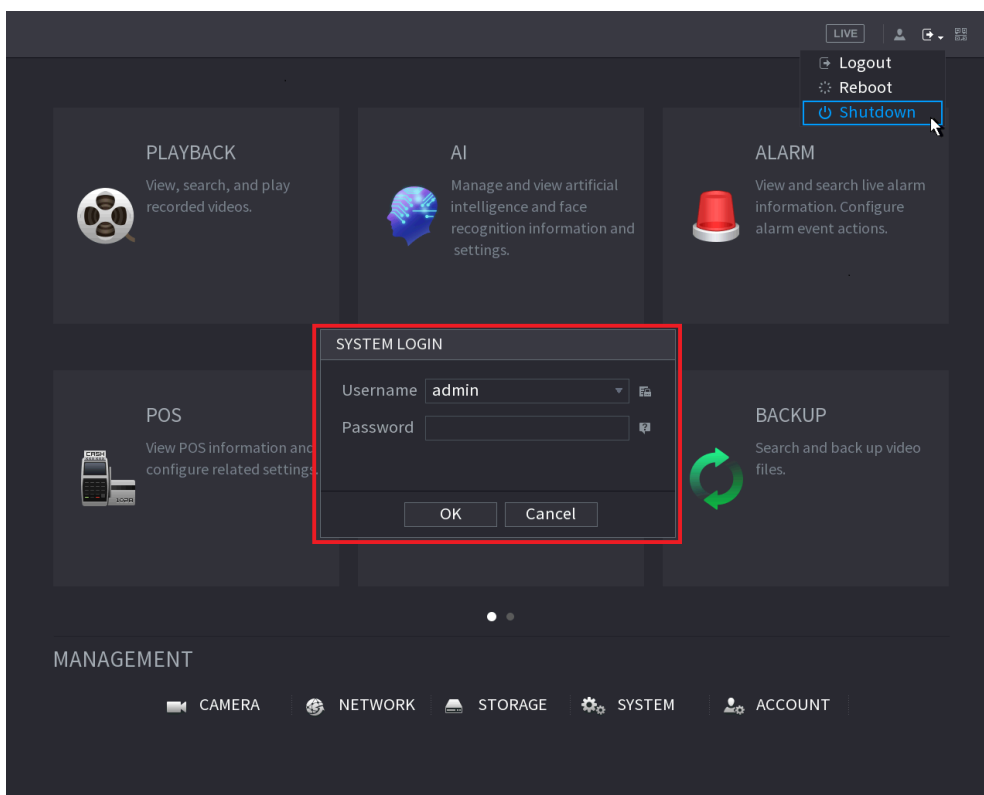

Figure 4-278



- Remote Control  
Press the power button on the remote for at least 3 seconds.
- Press the power button at the rear panel of the device.

## Auto Resume after Power Failure

The system can automatically backup video file and resume previous working status after power failure.



# 5 Web Operation



- The interfaces in the Manual are used for introducing the operations and only for reference. The actual interface might be different dependent on the model you purchased. If there is inconsistency between the Manual and the actual product, the actual product shall govern.
- The Manual is a general document for introducing the product, so there might be some functions described for the Device in the Manual not apply to the model you purchased.
- Besides Web, you can use our Smart PSS to login the device. For detailed information, refer to Smart PSS user's manual.

## 5.1 Network Connection



- The factory default IP of the Device is 192.168.1.108.
- The Device supports monitoring on different browsers such as Safari, Firefox, Google to perform the functions such as multi-channel monitoring, PTZ control, and device parameters configurations.

Step 1 Check to make sure the Device has connected to the network.

Step 2 Configure the IP address, subnet mask and gateway for the PC and the Device. For details about network configuration of the Device, refer to "4.12 Network".

Step 3 On your PC, check the network connection of the Device by using "ping \*\*\*.\*\*\*.\*\*\*.\*\*\*". Usually the return value of TTL is 255.

## 5.2 Web Login

Step 1 Open the browser, enter the IP address of the Device, and then press Enter. The Login in dialog box is displayed. See Figure 5-1.

Figure 5-1

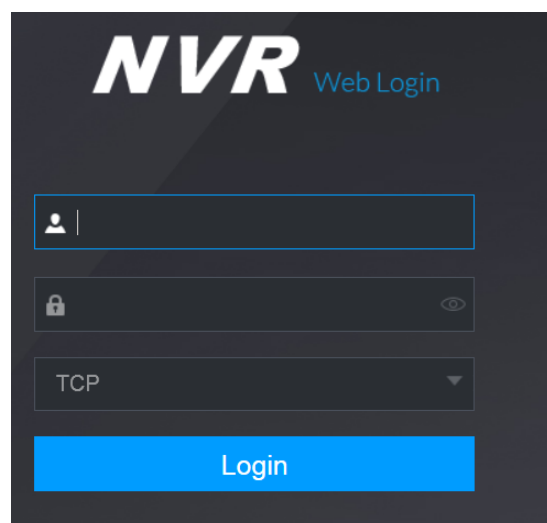

Step 2 Enter the user name and password.



- The default administrator account is **admin**. The password is the one that was configured during initial settings. To security your account, it is recommended to keep the password properly and change it regularly.
- Click  to display the password.
- If you forget the password, click **Forgot Password** to reset the password. For details about resetting the password, refer to "5.3 Reset Password".

Step 3 Click **Login**.

## 5.3 Reset Password

You can reset the password by the following methods when you forget the password for admin account.

- If the password reset function is enabled, you can use mobile phone to scan the QR code on the local interface or web interface to reset the password.
- If the password reset function is disabled, the system prompts indicating password resetting function is disabled. To reset the password, try either of the following ways:
  - ◇ Login the web with other user account to enable the password reset function.
  - ◇ Go to local interface to reset the password. For details, refer to "4.1.3 Reset Password".

Step 1 Login the Web of the Device.

The Login in dialog box is displayed. See Figure 5-2.

Figure 5-2

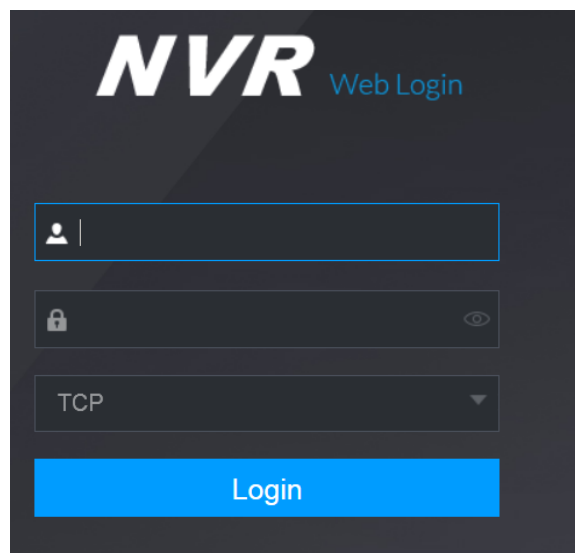

Step 2 Click **Forgot Password**.

The **Reset Password** interface is displayed. See Figure 5-3.

Figure 5-3

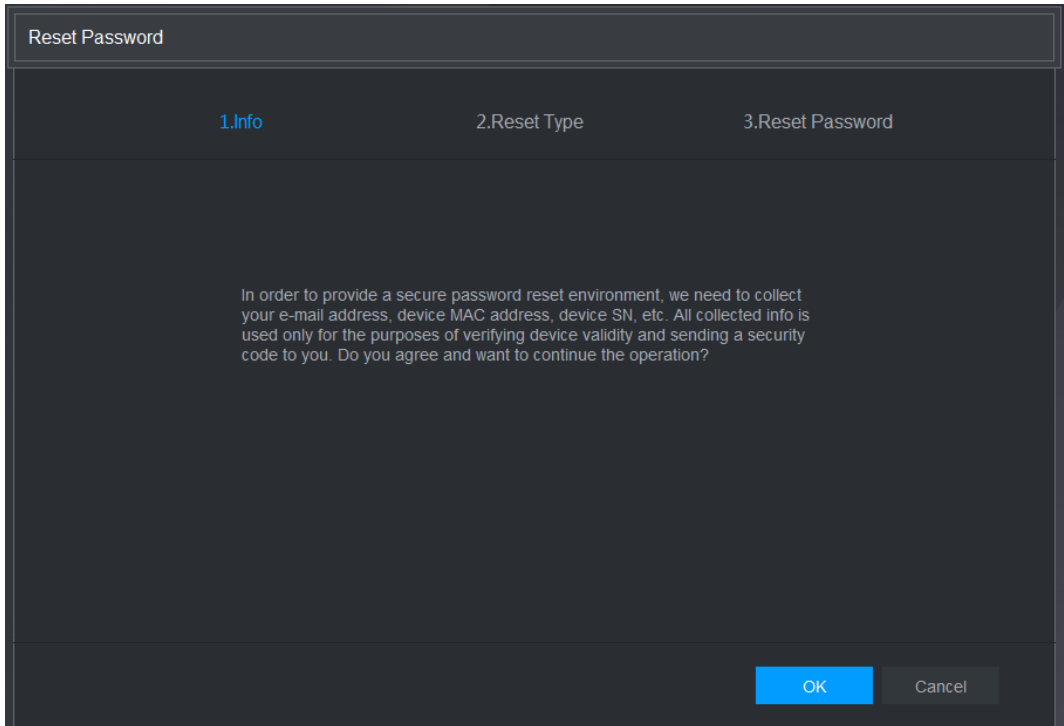

**Step 3** Click **OK**.

The reset type interface is displayed. See Figure 5-4.

Figure 5-4

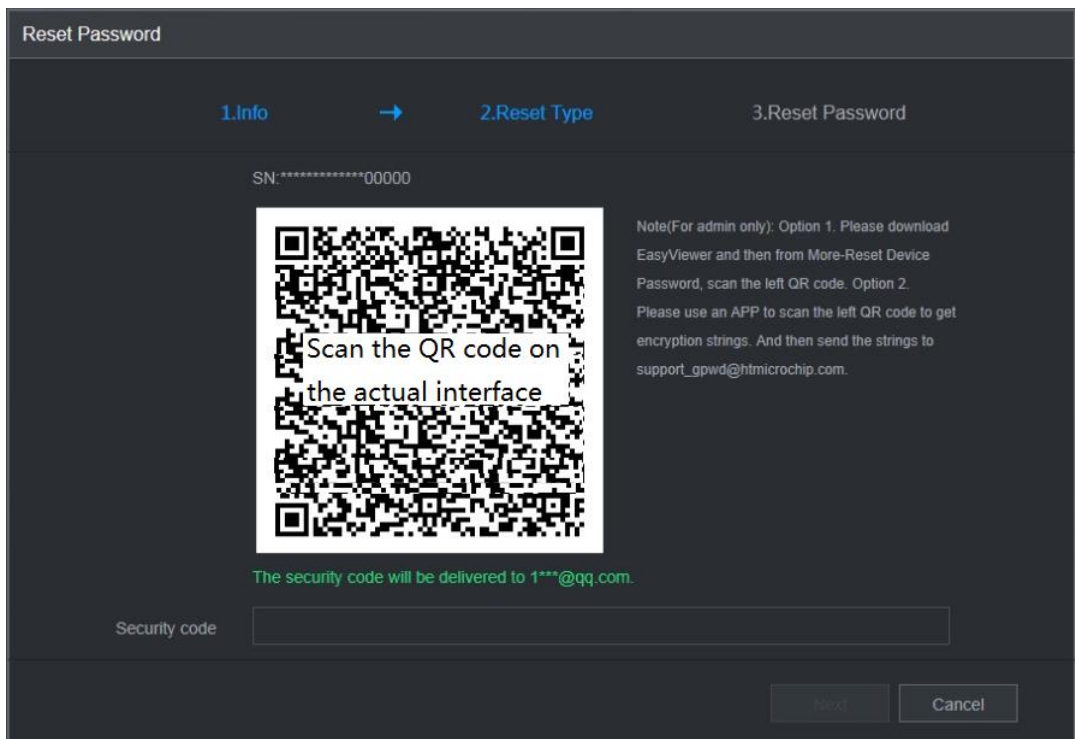

**Step 4** Follow the onscreen instructions to scan the QR code and get the security code.



- You can get the security code twice by scanning the same QR code. If you need to get the security code once again, refresh the interface.
- Use the security code received in your email box to reset the password within 24 hours; otherwise the security code becomes invalid.
- Wrong security code entrance up to five times will cause the security code locked for five minutes. After five minutes, you can continue to use this security code.

**Step 5** In the **Security code** box, enter the security code received in your reserved email box.

**Step 6** Click **Next**.

The new password resetting interface is displayed. See Figure 5-5.

Figure 5-5

**Step 7** In the **Password** box, enter the new password and enter it again in the **Confirm Password** box.



The new password can be set from 8 characters through 32 characters and contains at least two types from number, letter and special characters (excluding "", "", ";", ":" and "&").

**Step 8** Click **Save**. The password resetting is started.

After resetting is completed, a pop-up message is displayed to indicate the result and you will see the login interface is displayed. Then you can use the new password to login the web.

## 5.4 Web Main Menu

After you have logged in the Web, the main menu is displayed. See Figure 5-6.

For detailed operations, you can refer to " 4 Local Basic Operation."

Figure 5-6

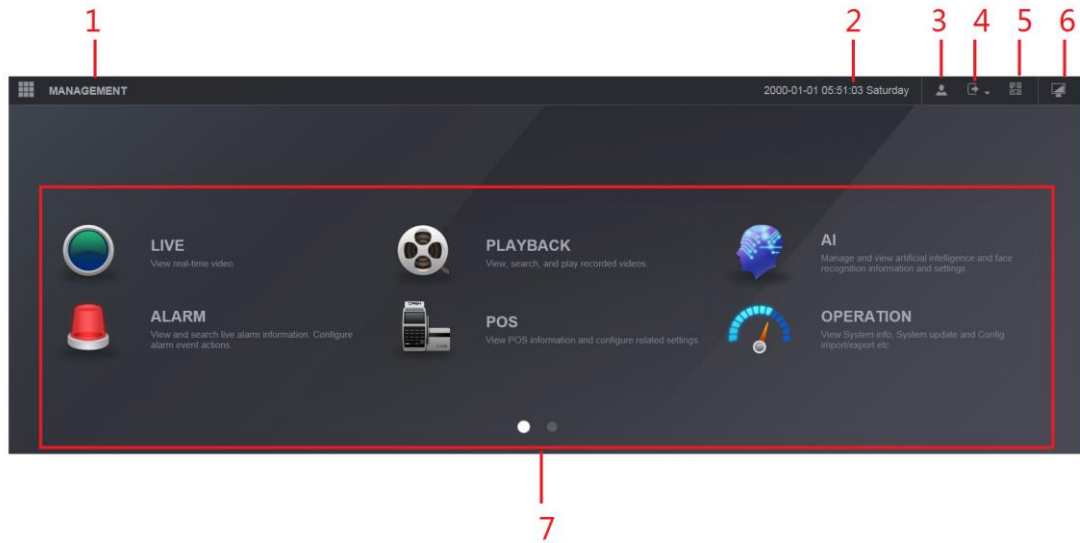

Table 5-1

No.	Icon	Description
1		<ul style="list-style-type: none"> <li>Includes configuration menu through which you can configure camera settings, network settings, storage settings, system settings, account settings, and view information.</li> </ul>
2	None	Displays system date and time.
3		When you point to  , the current user account is displayed.
4		Click  , select <b>Logout</b> , <b>Reboot</b> , or <b>Shutdown</b> according to your actual situation.
5		<p>Displays <b>Cell Phone Client</b> and <b>Device SN QR Code</b>.</p> <ul style="list-style-type: none"> <li>Cell Phone Client: Use your mobile phone to scan the QR code to add the device into the Cell Phone Client, and then you can start accessing the Device from your cell phone.</li> <li>Device SN: Obtain the Device SN by scanning the QR code. Go to the P2P management platform and add the Device SN into the platform. Then you can access and manage the device in the WAN. For details, refer to the P2P operation manual. You can also configure P2P function in the local configurations, refer to "4.1.4.3 P2P ".</li> </ul>
6		Displays the web main menu.

No.	Icon	Description
7	None	<p>Includes eight function tiles: <b>LIVE</b>, <b>PLAYBACK</b>, <b>AI</b>, <b>ALARM</b>, <b>POS</b>, <b>OPERATION</b>, <b>BACKUP</b>, <b>DISPLAY</b>, and <b>AUDIO</b>. Click each tile to open the configuration interface of the tile.</p> <ul style="list-style-type: none"> <li>● <b>LIVE</b>: You can perform the operations such as viewing real-time video, configuring channel layout, setting PTZ controls, and using smart talk and instant record functions if needed.</li> <li>● <b>PLAYBACK</b>: Search for and play back the recorded video saved on the Device.</li> <li>● <b>ALARM</b>: Search for alarm information and configure alarm event actions.</li> <li>● <b>AI</b>: Configure and manage artificial intelligent events. It includes smart search, parameters, and database.</li> <li>● <b>POS</b>: View POS information and configure related settings.</li> <li>● <b>OPERATION</b>: View system information, import/export system configuration files, or update system.</li> <li>● <b>BACKUP</b>: Search and back up the video files to the local PC or external storage device such as USB storage device.</li> <li>● <b>DISPLAY</b>: Configure the display effect such as displaying content, image transparency, and resolution, and enable the zero-channel function.</li> <li>● <b>AUDIO</b>: Manage audio files and configure the playing schedule. The audio file can be played in response to an alarm event if the voice prompts function is enabled.</li> </ul>

# Appendix 1 Glossary

- **DHCP:** DHCP (Dynamic Host Configuration Protocol) is a network protocol. It is one of the TCP/IP protocol cluster. It is principally used to assign temporary IP addresses to computers on a network.
- **DDNS:** DDNS (Dynamic Domain Name Server) is a service that maps Internet domain names to IP addresses. This service is useful to anyone who wants to operate a server (web server, mail server, ftp server and etc) connected to the internet with a dynamic IP or to someone who wants to connect to an office computer or server from a remote location with software.
- **eSATA:** eSATA(External Serial AT) is an interface that provides fast data transfer for external storage devices. It is the extension specifications of a SATA interface.
- **GPS:** GPS (Global Positioning System) is a satellite system, protected by the US military, safely orbiting thousands of kilometers above the earth.
- **PPPoE: PPPoE** (Point to Point Protocol over Ethernet) is a specification for connecting multiple computer users on an Ethernet local area network to a remote site. Now the popular mode is ADSL and it adopts PPPoE protocol.
- **Wi-Fi:** Wi-Fi is the name of a popular wireless networking technology that uses radio waves to provide wireless high-speed Internet and network connections. The standard is for wireless local area networks (WLANs). It is like a common language that all the devices use to communicate to each other. It is actually IEEE802.11, a family of standard The IEEE (Institute of Electrical and Electronics Engineers Inc.)
- **3G:** 3G is the wireless network standard. It is called 3G because it is the third generation of cellular telecom standards. 3G is a faster network for phone and data transmission and speed is over several hundred kbps. Now there are four standards: CDMA2000, WCDMA, TD-SCDMA and WiMAX.
- **Dual-stream:** The dual-stream technology adopts high-rate bit stream for local HD storage such as QCIF/CIF/2CIF/DCIF/4CIF encode and one low-rate bit stream for network transmission such as QCIF/CIF encode. It can balance the local storage and remote network transmission. The dual-stream can meet the difference band width requirements of the local transmission and the remote transmission. In this way, the local transmission using high-bit stream can achieve HD storage and the network transmission adopting low bit stream suitable for the fluency requirements of the 3G network such as WCDMA, EVDO, TD-SCDMA..
- **On-off value:** It is the non-consecutive signal sampling and output. It includes remote sampling and remote output. It has two statuses: 1/0.

## Appendix 2 FAQ

Questions	Solutions
<p><b>NVR cannot boot up properly.</b></p>	<ul style="list-style-type: none"> <li>● Input power is not correct.</li> <li>● Power connection is not correct.</li> <li>● Power switch button is damaged.</li> <li>● Program upgrade is wrong.</li> <li>● HDD malfunction or something wrong with HDD ribbon.</li> <li>● Seagate DB35.1, DB35.2, SV35 or Maxtor 17-g has compatibility problem. Please upgrade to the latest version to solve this problem.</li> <li>● Front panel error.</li> <li>● Main board is damaged.</li> </ul>
<p><b>NVR often automatically shuts down or stops running.</b></p>	<ul style="list-style-type: none"> <li>● Input voltage is not stable or it is too low.</li> <li>● HDD malfunction or something wrong with the ribbon.</li> <li>● Button power is not enough.</li> <li>● Front video signal is not stable.</li> <li>● Working environment is too harsh, too much dust.</li> <li>● Hardware malfunction.</li> </ul>
<p><b>System cannot detect hard disk.</b></p>	<ul style="list-style-type: none"> <li>● HDD is broken.</li> <li>● HDD ribbon is damaged.</li> <li>● HDD cable connection is loose.</li> <li>● Main board SATA port is broken.</li> </ul>
<p><b>There is no video output whether it is one-channel, multiple-channel or all-channel output.</b></p>	<ul style="list-style-type: none"> <li>● Program is not compatible. Please upgrade to the latest version.</li> <li>● Brightness is 0. Please restore factory default setup.</li> <li>● Check your screen saver.</li> <li>● NVR hardware malfunctions.</li> </ul>
<p><b>I cannot search local records.</b></p>	<ul style="list-style-type: none"> <li>● HDD ribbon is damaged.</li> <li>● HDD is broken.</li> <li>● Upgraded program is not compatible.</li> <li>● The recorded file has been overwritten.</li> <li>● Record function has been disabled.</li> </ul>
<p><b>Video is distorted when searching local records.</b></p>	<ul style="list-style-type: none"> <li>● Video quality setup is too low.</li> <li>● Program read error, bit data is too small. There is mosaic in the full screen. Please restart the NVR to solve this problem.</li> <li>● HDD data ribbon error.</li> <li>● HDD malfunction.</li> <li>● NVR hardware malfunctions.</li> </ul>



Questions	Solutions
<b>Time display is not correct.</b>	<ul style="list-style-type: none"> <li>● Setup is not correct</li> <li>● Battery contact is not correct or voltage is too low.</li> <li>● Crystal is broken.</li> </ul>
<b>NVR cannot control PTZ.</b>	<ul style="list-style-type: none"> <li>● Front panel PTZ error</li> <li>● PTZ decoder setup, connection or installation is not correct.</li> <li>● Cable connection is not correct.</li> <li>● PTZ setup is not correct.</li> <li>● PTZ decoder and NVR protocol is not compatible.</li> <li>● PTZ decoder and NVR address is not compatible.</li> <li>● When there are several decoders, please add 120 Ohm between the PTZ decoder A/B cables furthest end to delete the reverberation or impedance matching. Otherwise the PTZ control is not stable.</li> <li>● The distance is too far.</li> </ul>
<b>I cannot log in client-end or web.</b>	<ul style="list-style-type: none"> <li>● For Windows 98 or Windows ME user, please update your system to Windows 2000 sp4. Or you can install client-end software of lower version. Please note right now, our NVR is not compatible with Windows VISTA control.</li> <li>● ActiveX control has been disabled.</li> <li>● No dx8.1 or higher. Please upgrade display card driver.</li> <li>● Network connection error.</li> <li>● Network setup error.</li> <li>● Password or user name is invalid.</li> <li>● Client-end is not compatible with NVR program.</li> </ul>
<b>There is only mosaic no video when preview or playback video file remotely.</b>	<ul style="list-style-type: none"> <li>● Network fluency is not good.</li> <li>● Client-end resources are limit.</li> <li>● Current user has no right to monitor.</li> </ul>
<b>Network connection is not stable.</b>	<ul style="list-style-type: none"> <li>● Network is not stable.</li> <li>● IP address conflict.</li> <li>● MAC address conflict.</li> <li>● PC or device network card is not good.</li> </ul>
<b>Burn error /USB back error.</b>	<ul style="list-style-type: none"> <li>● Burner and NVR are in the same data cable.</li> <li>● System uses too much CPU resources. Please stop record first and then begin backup.</li> <li>● Data amount exceeds backup device capacity. It may result in burner error.</li> <li>● Backup device is not compatible.</li> <li>● Backup device is damaged.</li> </ul>
<b>Keyboard cannot control NVR.</b>	<ul style="list-style-type: none"> <li>● NVR serial port setup is not correct</li> <li>● Address is not correct</li> <li>● When there are several switchers, power supply is not enough.</li> <li>● Transmission distance is too far.</li> </ul>

Questions	Solutions
<b>Alarm signal cannot be disarmed.</b>	<ul style="list-style-type: none"> <li>● Alarm setup is not correct.</li> <li>● Alarm output has been open manually.</li> <li>● Input device error or connection is not correct.</li> <li>● Some program versions may have this problem. Please upgrade your system.</li> </ul>
<b>Alarm function is null.</b>	<ul style="list-style-type: none"> <li>● Alarm setup is not correct.</li> <li>● Alarm cable connection is not correct.</li> <li>● Alarm input signal is not correct.</li> <li>● There are two loops connect to one alarm device.</li> </ul>
<b>Record storage period is not enough.</b>	<ul style="list-style-type: none"> <li>● Camera quality is too low. Lens is dirty. Camera is installed against the light. Camera aperture setup is not correct.</li> <li>● HDD capacity is not enough.</li> <li>● HDD is damaged.</li> </ul>
<b>Cannot playback the downloaded file.</b>	<ul style="list-style-type: none"> <li>● There is no media player.</li> <li>● No DXB8.1 or higher graphic acceleration software.</li> <li>● There is no DivX503Bundle.exe control when you play the file transformed to AVI via media player.</li> <li>● No DivX503Bundle.exe or ffdshow-2004 1012 .exe in Windows XP OS.</li> </ul>
<b>Forgot local menu operation password or network password</b>	<ul style="list-style-type: none"> <li>● Please contact your local service engineer or our sales person for help. We can guide you to solve this problem.</li> </ul>
<b>There is no video. The screen is in black.</b>	<ul style="list-style-type: none"> <li>● IPC IP address is not right.</li> <li>● IPC port number is not right.</li> <li>● IPC account (user name/password) is not right.</li> <li>● IPC is offline.</li> </ul>
<b>The displayed video is not full in the monitor.</b>	Please check current resolution setup. If the current setup is 1920*1080, then you need to set the monitor resolution as 1920*1080.
<b>There is no HDMI output.</b>	<ul style="list-style-type: none"> <li>● Displayer is not in HDMI mode.</li> <li>● HDMI cable connection is not right.</li> </ul>
<b>The video is not fluent when I view in multiple-channel mode from the client-end.</b>	<ul style="list-style-type: none"> <li>● The network bandwidth is not sufficient. The multiple-channel monitor operation needs at least 100M or higher.</li> <li>● Your PC resources are not sufficient. For 16-ch remote monitor operation, the PC shall have the following environment: Quad Core, 2G or higher memory, independent displayer, display card memory 256M or higher.</li> </ul>

Questions	Solutions
<b>I can not connect to the IPC</b>	<ul style="list-style-type: none"> <li>● Please make sure the IPC has booted up.</li> <li>● IPC network connection is right and it is online</li> <li>● IPC IP is in the blacklist.</li> <li>● The device has connected to the too many IPC. It cannot transmit the video.</li> <li>● Check the IPC port value and the time zone is the same as the NVR.</li> <li>● Make sure current network environment is stable.</li> </ul>
<b>After I set the NVR resolution as 1080P, my monitor can not display.</b>	Shut down the device and then reboot. When you reboot, please press the Fn button at the same time and then release after 5 seconds. You can restore NVR resolution to the default setup.
<b>My admin account has been changed and I can not log in.</b>	Use telnet and then input the following command: <pre>cd /mnt/mtd/Config/ rm -rf group rm -rf password</pre> Reboot the device to restore the default password.
<b>After I login the Web , I can not find the remote interface to add the IPC.</b>	Please clear the Web controls and load again.
<b>There is IP and gateway, I can access the internet via the router. But I can not access the internet after I reboot the NVR.</b>	Please use command PING to check you can connect to the gateway or not. Use telnet to access and then use command "ifconfig -a" to check device IP address. If you see the subnet mask and the gateway has changed after the reboot. Please upgrade the applications and set again.
<b>I use the VGA montior.I want to know if I use the multiple-window mode, I see the video from the main stream or the sub stream?</b>	<ul style="list-style-type: none"> <li>● For 32-channel series product, the 9/16-window is using the sub stream.</li> <li>● For 4/8/16 series product, system is using the main stream no matter you are in what display mode.</li> </ul>

## Daily Maintenance

- Please use the brush to clean the board, socket connector and the chassis regularly.
- The device shall be soundly earthed in case there is audio/video disturbance. Keep the device away from the static voltage or induced voltage.
- Please unplug the power cable before you remove the audio/video signal cable, RS232 or RS485 cable.
- Do not connect the TV to the local video output port (VOUT).It may result in video output circuit.
- Always shut down the device properly. Please use the shutdown function in the menu, or you can press the power button in the rear pane for at least three seconds to shut down the device.

Otherwise it may result in HDD malfunction.

- Please make sure the device is away from the direct sunlight or other heating sources. Please keep the sound ventilation.
- Please check and maintain the device regularly.

# Appendix 3 Cybersecurity Recommendations

---

Cybersecurity is more than just a buzzword: it's something that pertains to every device that is connected to the internet. IP video surveillance is not immune to cyber risks, but taking basic steps toward protecting and strengthening networks and networked appliances will make them less susceptible to attacks. Below are some tips and recommendations on how to create a more secured security system.

## **Mandatory actions to be taken for basic equipment network security:**

### **1. Use Strong Passwords**

Please refer to the following suggestions to set passwords:

- The length should not be less than 8 characters;
- Include at least two types of characters; character types include upper and lower case letters, numbers and symbols;
- Do not contain the account name or the account name in reverse order;
- Do not use continuous characters, such as 123, abc, etc.;
- Do not use overlapped characters, such as 111, aaa, etc.;

### **2. Update Firmware and Client Software in Time**

- According to the standard procedure in Tech-industry, we recommend to keep your equipment (such as NVR, DVR, IP camera, etc.) firmware up-to-date to ensure the system is equipped with the latest security patches and fixes. When the equipment is connected to the public network, it is recommended to enable the “auto-check for updates” function to obtain timely information of firmware updates released by the manufacturer.
- We suggest that you download and use the latest version of client software.

## **“Nice to have” recommendations to improve your equipment network security:**

### **1. Physical Protection**

We suggest that you perform physical protection to equipment, especially storage devices. For example, place the equipment in a special computer room and cabinet, and implement well-done access control permission and key management to prevent unauthorized personnel from carrying out physical contacts such as damaging hardware, unauthorized connection of removable equipment (such as USB flash disk, serial port), etc.

### **2. Change Passwords Regularly**

We suggest that you change passwords regularly to reduce the risk of being guessed or cracked.

### **3. Set and Update Passwords Reset Information Timely**

The equipment supports password reset function. Please set up related information for password reset in time, including the end user's mailbox and password protection questions. If the information changes, please modify it in time. When setting password protection questions, it is suggested not to use those that can be easily guessed.

### **4. Enable Account Lock**

The account lock feature is enabled by default, and we recommend you to keep it on to guarantee the account security. If an attacker attempts to log in with the wrong password several times, the corresponding account and the source IP address will be locked.

#### **5. Change Default HTTP and Other Service Ports**

We suggest you to change default HTTP and other service ports into any set of numbers between 1024~65535, reducing the risk of outsiders being able to guess which ports you are using.

#### **6. Enable HTTPS**

We suggest you to enable HTTPS, so that you visit Web service through a secure communication channel.

#### **7. Enable Whitelist**

We suggest you to enable whitelist function to prevent everyone, except those with specified IP addresses, from accessing the system. Therefore, please be sure to add your computer's IP address and the accompanying equipment's IP address to the whitelist.

#### **8. MAC Address Binding**

We recommend you to bind the IP and MAC address of the gateway to the equipment, thus reducing the risk of ARP spoofing.

#### **9. Assign Accounts and Privileges Reasonably**

According to business and management requirements, reasonably add users and assign a minimum set of permissions to them.

#### **10. Disable Unnecessary Services and Choose Secure Modes**

If not needed, it is recommended to turn off some services such as SNMP, SMTP, UPnP, etc., to reduce risks.

If necessary, it is highly recommended that you use safe modes, including but not limited to the following services:

- SNMP: Choose SNMP v3, and set up strong encryption passwords and authentication passwords.
- SMTP: Choose TLS to access mailbox server.
- FTP: Choose SFTP, and set up strong passwords.
- AP hotspot: Choose WPA2-PSK encryption mode, and set up strong passwords.

#### **11. Audio and Video Encrypted Transmission**

If your audio and video data contents are very important or sensitive, we recommend that you use encrypted transmission function, to reduce the risk of audio and video data being stolen during transmission.

Reminder: encrypted transmission will cause some loss in transmission efficiency.

#### **12. Secure Auditing**

- Check online users: we suggest that you check online users regularly to see if the device is logged in without authorization.
- Check equipment log: By viewing the logs, you can know the IP addresses that were used to log in to your devices and their key operations.

#### **13. Network Log**

Due to the limited storage capacity of the equipment, the stored log is limited. If you need to save the log for a long time, it is recommended that you enable the network log function to ensure that the critical logs are synchronized to the network log server for tracing.

#### **14. Construct a Safe Network Environment**

In order to better ensure the safety of equipment and reduce potential cyber risks, we recommend:

- Disable the port mapping function of the router to avoid direct access to the intranet devices from external network.
- The network should be partitioned and isolated according to the actual network needs. If there are no communication requirements between two sub networks, it is suggested to use VLAN, network GAP and other technologies to partition the network, so as to achieve the network isolation effect.
- Establish the 802.1x access authentication system to reduce the risk of unauthorized access to private networks.

## Appendix 4 HDD Capacity Calculation

Calculate total capacity needed by each device according to video recording (video recording type and video file storage time).

Step 1: According to Formula (1) to calculate storage capacity  $q_i$  that is the capacity of each channel needed for each hour, unit Mbyte.

$$q_i = d_i \div 8 \times 3600 \div 1024 \quad (1)$$

In the formula:  $d_i$  means the bit rate, unit Kbit/s

Step 2: After video time requirement is confirmed, according to Formula (2) to calculate the storage capacity  $m_i$ , which is storage of each channel needed unit Mbyte.

$$m_i = q_i \times h_i \times D_i \quad (2)$$

In the formula:

$h_i$  means the recording time for each day (hour)

$D_i$  means number of days for which the video shall be kept

Step 3: According to Formula (3) to calculate total capacity (accumulation)  $q_T$  that is needed for all channels in the device during **scheduled video recording**.

$$q_T = \sum_{i=1}^c m_i \quad (3)$$

In the formula:  $c$  means total number of channels in one device

Step 4: According to Formula (4) to calculate total capacity (accumulation)  $q_T$  that is needed for all channels in device during **alarm video recording (including motion detection)**.

$$q_T = \sum_{i=1}^c m_i \times a\% \quad (4)$$

In the formula:  $a\%$  means alarm occurrence rate



## Appendix 5 Compatible Network Camera List

Please note all the models in the following list for reference only. For those products not included in the list, please contact your local retailer or technical supporting engineer for detailed information.

Manufacture	Model	Version	Video Encode	Audio/Video	Protocol
AXIS	P1346	5.40.9.2	H264	√	ONVIF/Private
	P3344/P3344-E	5.40.9.2	H264	√	ONVIF/Private
	P5512	—	H264	√	ONVIF/Private
	Q1604	5.40.3.2	H264	√	ONVIF/Private
	Q1604-E	5.40.9	H264	√	ONVIF/Private
	Q6034E	—	H264	√	ONVIF/Private
	Q6035	5.40.9	H264	√	ONVIF/Private
	Q1755	—	H264	√	ONVIF/Private
	M7001	—	H264	√	Private
	M3204	5.40.9.2	H264	√	Private
	P3367	HEAD LFP4_0 130220	H264	√	ONVIF
P5532-P	HEAD LFP4_0 130220	H264	√	ONVIF	
ACTi	ACM-3511	A1D-220-V3.12 .15-AC	MPEG4	√	Private
	ACM-8221	A1D-220-V3.13 .16-AC	MPEG4	√	Private
Arecont	AV1115	65246	H264	√	Private
	AV10005DN	65197	H264	√	Private
	AV2115DN	65246	H264	√	Private
	AV2515DN	65199	H264	√	Private
	AV2815	65197	H264	√	Private
	AV5115DN	65246	H264	√	Private
	AV8185DN	65197	H264	√	Private
Bosch	NBN-921-P	—	H264	√	ONVIF
	NBC-455-12P	—	H264	√	ONVIF
	VG5-825	9500453	H264	√	ONVIF
	NBN-832	66500500	H264	√	ONVIF
	VEZ-211-IWT EIVA	—	H264	√	ONVIF
	NBC-255-P	15500152	H264	√	ONVIF
	VIP-X1XF	—	H264	√	ONVIF
Brikcom	B0100	—	H264	√	ONVIF

Manufacture	Model	Version	Video Encode	Audio/Video	Protocol
	D100	—	H264	√	ONVIF
	GE-100-CB	—	H264	√	ONVIF
	FB-100A	v1.0.3.9	H264	√	ONVIF
	FD-100A	v1.0.3.3	H264	√	ONVIF
Cannon	VB-M400	—	H264	√	Private
CNB	MPix2.0DIR	XNETM112011 1229	H264	√	ONVIF
	VIPBL1.3MIR VF	XNETM210011 1229	H264	√	ONVIF
	IGC-2050F	XNETM210011 1229	H264	√	ONVIF
CP PLUS	CP-NC9-K	6.E.2.7776	H264	√	ONVIF/Private
	CP-NC9W-K	6.E.2.7776	H264	√	Private
	CP-ND10-R	cp20111129AN S	H264	√	ONVIF
	CP-ND20-R	cp20111129AN S	H264	√	ONVIF
	CP-NS12W-C R	cp20110808NS	H264	√	ONVIF
	VS201	cp20111129NS	H264	√	ONVIF
	CP-NB20-R	cp20110808BN S	H264	√	ONVIF
	CP-NT20VL3- R	cp20110808BN S	H264	√	ONVIF
	CP-NS36W-A R	cp20110808NS	H264	√	ONVIF
	CP-ND20VL2- R	cp20110808BN S	H264	√	ONVIF
	CP-RNP-1820	cp20120821NS A	H264	√	Private
	CP-RNC-TP2 0FL3C	cp20120821NS A	H264	√	Private
	CP-RNP-12D	cp20120828AN S	H264	√	Private
	CP-RNC-DV1 0	cp20120821NS A	H264	√	Private
CP-RNC-DP2 0FL2C	cp20120821NS A	H264	√	Private	
Dynacolor	ICS-13	d20120214NS	H264	√	ONVIF/Private
	ICS-20W	vt20111123NSA	H264	√	ONVIF/Private
	NA222	—	H264	√	ONVIF
	MPC-IPVD-03 13	k20111208ANS	H264	√	ONVIF/Private

Manufacture	Model	Version	Video Encode	Audio/Video	Protocol
	MPC-IPVD-0313AF	k20111208BNS	H264	√	ONVIF/Private
Honeywell	HIDC-1100PT	h.2.2.1824	H264	√	ONVIF
	HIDC-1100P	h.2.2.1824	H264	√	ONVIF
	HIDC-0100P	h.2.2.1824	H264	√	ONVIF
	HIDC-1300V	2.0.0.21	H264	√	ONVIF
	HICC-1300W	2.0.1.7	H264	√	ONVIF
	HICC-2300	2.0.0.21	H264	√	ONVIF
	HDZ20HDX	H20130114NSA	H264	√	ONVIF
LG	LW342-FP	—	H264	√	Private
	LNB5100	—	H264	√	ONVIF
Imatek	KNC-B5000	—	H264	√	Private
	KNC-B5162	—	H264	√	Private
	KNC-B2161	—	H264	√	Private
Panasonic	NP240/CH	—	MPEG4	√	Private
	WV-NP502	—	MPEG4	√	Private
	WV-SP102H	1.41	H264	√	ONVIF/Private
	WV-SP105H	—	H264	√	ONVIF/Private
	WV-SP302H	1.41	H264、MPEG4	√	ONVIF/Private
	WV-SP306H	1.4	H264、MPEG4	√	ONVIF/Private
	WV-SP508H	—	H264、MPEG4	√	ONVIF/Private
	WV-SP509H	—	H264、MPEG4	√	ONVIF/Private
	WV-SF332H	1.41	H264、MPEG4	√	ONVIF/Private
	WV-SW316H	1.41	H264、MPEG4	√	ONVIF/Private
	WV-SW355H	1.41	H264、MPEG4	√	ONVIF/Private
	WV-SW352H	—	H264、MPEG4	√	ONVIF/Private
	WV-SW152E	1.03	H264、MPEG4	√	ONVIF/Private
	WV-SW558H	—	H264、MPEG4	√	ONVIF/Private
	WV-SW559H	—	H264、MPEG4	√	ONVIF/Private
	WV-SP105H	1.03	H264、MPEG4	√	ONVIF/Private
	WV-SW155E	1.03	H264、MPEG4	√	ONVIF/Private
	WV-SF336H	1.44	H264、MPEG4	√	ONVIF/Private
	WV-SF332H	1.41	H264、MPEG4	√	ONVIF/Private
	WV-SF132E	1.03	H264、MPEG4	√	ONVIF/Private
	WV-SF135E	1.03	H264、MPEG4	√	ONVIF/Private
	WV-SF346H	1.41	H264、MPEG4	√	ONVIF/Private
	WV-SF342H	1.41	H264、MPEG4	√	ONVIF/Private
	WV-SC385H	1.08	H264、MPEG4	√	ONVIF/Private
	WV-SC386H	1.08	H264、MPEG4	√	ONVIF/Private
	WV-SP539	1.66	H264、MPEG4	√	ONVIF
	DG-SC385	1.66	H264、MPEG4	√	ONVIF
PELCO	IXSOLW	1.8.1-20110912	H264	√	Private

Manufacture	Model	Version	Video Encode	Audio/Video	Protocol
		-1.9082-A1.6617			
	IDE20DN	1.7.41.9111-O3.6725	H264	√	Private
	D5118	1.7.8.9310-A1.5288	H264	√	Private
	IM10C10	1.6.13.9261-O2.4657	H264	√	Private
	DD4N-X	01.02.0015	MPEG4	√	Private
	DD423-X	01.02.0006	MPEG4	√	Private
	D5220	1.8.3-FC2-20120614-1.9320-A1.8035	H264	√	Private
Samsung	SNB-3000P	2.41	H264、MPEG4	√	ONVIF/Private
	SNP-3120	1.22_110120_1	H264、MPEG4	√	ONVIF/Private
	SNP-3370	1.21_110318	MPEG4	√	Private
	SNB-5000	2.10_111227	H264、MPEG4	√	ONVIF/Private
	SND-5080	—	H264、MPEG4	√	Private
	SNZ-5200	1.02_110512	H264、MPEG4	√	ONVIF/Private
	SNP-5200	1.04_110825	H264、MPEG4	√	ONVIF/Private
	SNB-7000	1.10_110819	H264	√	ONVIF/Private
	SNB-6004	V1.0.0	H264	√	ONVIF
Sony	SNC-DH110	1.50.00	H264	√	ONVIF/Private
	SNC-CH120	1.50.00	H264	√	ONVIF/Private
	SNC-CH135	1.73.01	H264	√	ONVIF/Private
	SNC-CH140	1.50.00	H264	√	ONVIF/Private
	SNC-CH210	1.73.00	H264	√	ONVIF/Private
	SNC-DH210	1.73.00	H264	√	ONVIF/Private
	SNC-DH240	1.50.00	H264	√	ONVIF/Private
	SNC-DH240-T	1.73.01	H264	√	ONVIF/Private
	SNC-CH260	1.74.01	H264	√	ONVIF/Private
	SNC-CH280	1.73.01	H264	√	ONVIF/Private
	SNC-RH-124	1.73.00	H264	√	ONVIF/Private
	SNC-RS46P	1.73.00	H264	√	ONVIF/Private
	SNC-ER550	1.74.01	H264	√	ONVIF/Private
	SNC-ER580	1.74.01	H264	√	ONVIF/Private
	SNC-ER580	1.78.00	H264	√	ONVIF
	SNC-VM631	1.4.0	H264	√	ONVIF
	WV-SP306	1.61.00	H264、MPEG4	√	SDK
	WV-SP306	1.61.00	H264	√	ONVIF
	SNC-VB600	1.5.0	H264	√	Private
	SNC-VM600	1.5.0	H264	√	Private
SNC-VB630	1.5.0	H264	√	Private	

<b>Manufacture</b>	<b>Model</b>	<b>Version</b>	<b>Video Encode</b>	<b>Audio/Video</b>	<b>Protocol</b>
	SNC-VM630	1.5.0	H264	√	Private
SANYO	VCC-HDN400 0PC	—	H264	√	ONVIF