

**Unit Door Station User's Manual**  
**----VTO12XX Series**

## **Welcome**

Thank you for purchasing our product!

This quick start guide is designed to be a reference tool for your system.

Please keep it well for future reference!

# Table of Contents

1	Overview .....	1
2	Basic Functions.....	6
2.1	Call MGT center .....	6
2.2	Call Users .....	6
2.2.1	Call Status .....	6
2.2.2	Communication status .....	6
2.3	Monitor Function .....	6
2.4	Unlock Function .....	7
2.4.1	Unlock During the Dial Process.....	7
2.4.2	Unlock During the Communication.....	7
2.4.3	Unlock During the MON.....	7
2.4.4	Unlock via the Password .....	7
2.4.5	Unlock via IC card.....	7
2.5	Environment Light Compensation Function .....	7
2.6	Access Control (A&C) Function .....	8
2.7	Vandal Proof Function .....	8
2.8	Approaching Induction.....	8
3	Web Function.....	8
3.1	Overview .....	8
3.2	Basic Functions .....	9
3.2.1	Login Interface .....	9
3.2.2	System Settings .....	10
3.2.3	VTH Management .....	13
4	Specifications .....	17
5	Device Port.....	18
6	Installation .....	22
7	FAQ .....	24

# 1 Overview

Connect the device to the power, the system boots up properly. After one minute, the screen turns on and the boot-up completes, system goes to the normal working interface. The front panel is shown as in [错误! 未找到引用源。](#) and Figure 1- 2.

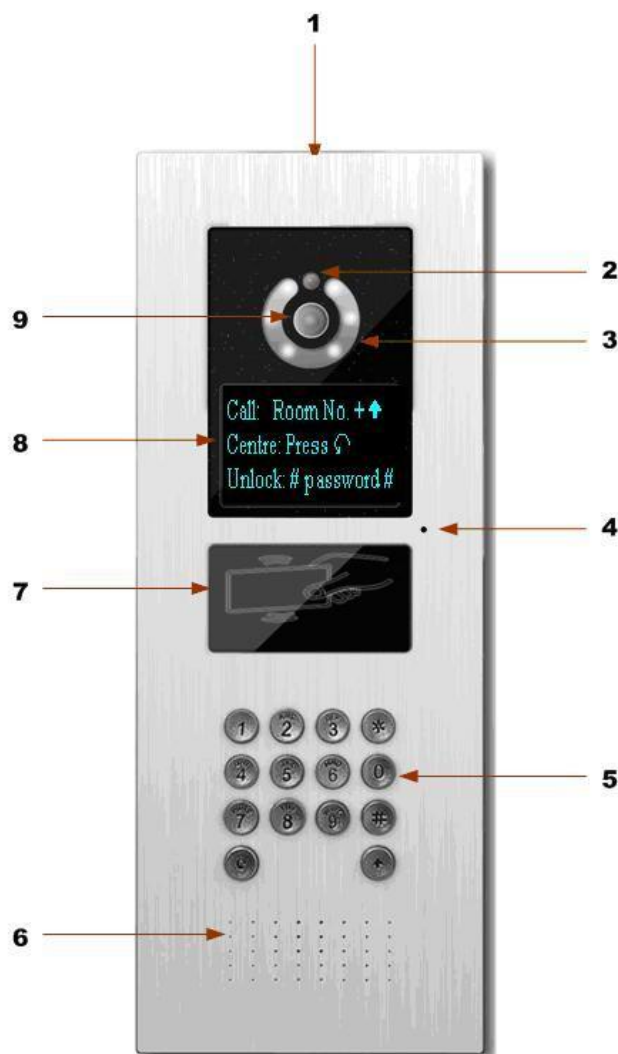













Figure 1- 1

Please refer to the following sheet for detailed information.

SN	Name	Function
1	Logo	Decoration logo.
2	Photo sensor	It can detect the environment light. It is a compensation light option.
3	Compensation Light	It can compensate the camera light in the low illumination environments.
4	Microphone	Audio input

5	Key Panel	<p>1.  Button.</p> <p>a) Backspace function. It is to delete the previous symbol.</p> <p>b) Hang up function. It is to hang up the call.</p> <p>2. Number button. Input the number 0 to 9.</p> <p>3.  button. When you are using the password to open the door. Press this button once to begin input. After you input the password, please press it again to complete the operation.</p> <p>4.  Call button. After you input the room number, press it to begin a dial up.</p> <p>5.  Call management (MGT) center button. Press it to call the MGT center directly.</p>
6	Speaker	Output audio
7	Card Induction zone	Use the card to open the door.
8	LCD	<p>Here you can view prompt information, date, time and etc.</p> <p>Note:</p> <p>1. "Call: Room No. +  ". Please input the room number first and then press the button  to dial;</p> <p>2."Center: Press  button". Please press the button  to call the MGT center.</p> <p>3."Unlock:  + password +  ", If you want to open the door via the password, please press the button  and then input the room number and password. Please press the button </p>

		to confirm.
9	Camera	It is to monitor the video of the door.

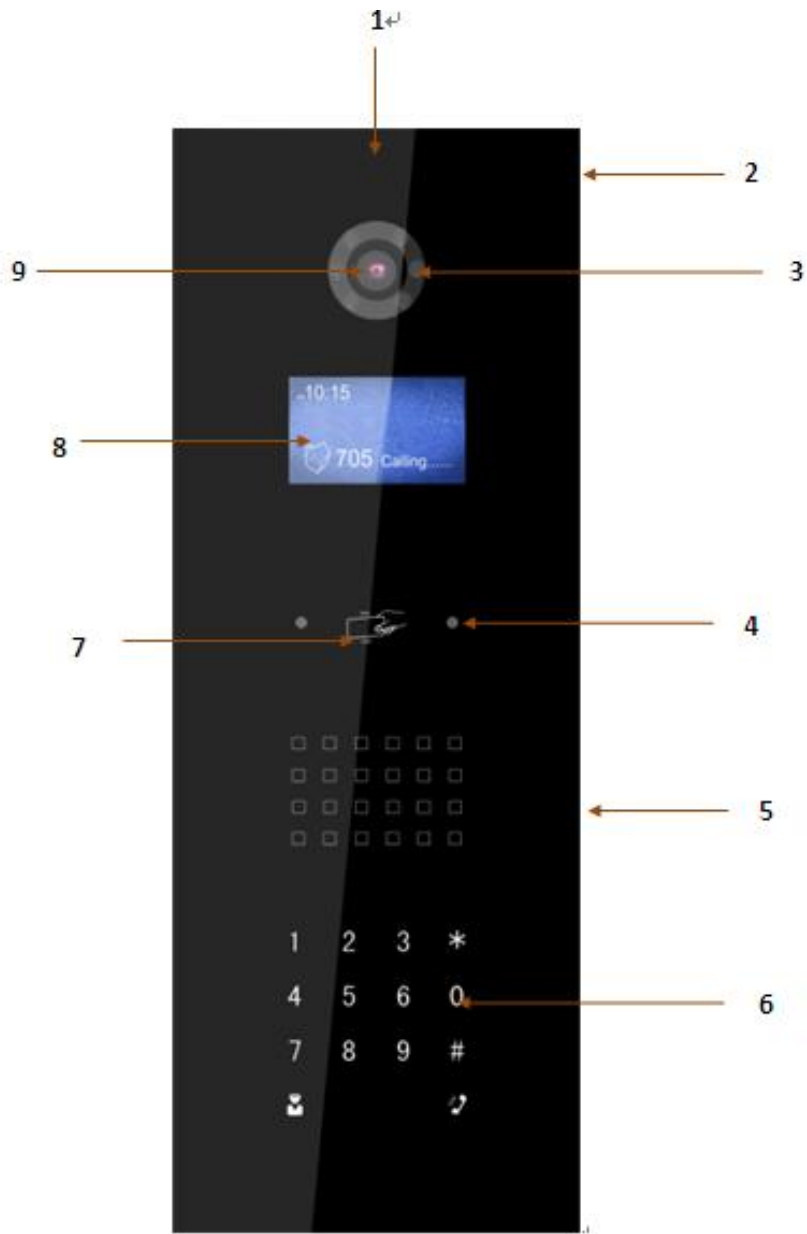







Figure 1- 2

Please refer to the following sheet for detailed information.



SN	Name	Function
1	Logo	Printed logo.
2	Microphone	Audio input
3	Compensation Light	It can compensate the camera light in the low illumination environments.
4	Approaching Induction	It can detect approaching body.
5	Speaker	Output audio

6	Key Panel	<ol style="list-style-type: none"> <li>1. * Button. <ol style="list-style-type: none"> <li>a) Backspace function. It is to delete the previous symbol.</li> <li>b) Hang up function. It is to hang up the call.</li> </ol> </li> <li>2. Number button. Input the number 0 to 9.</li> <li>3. # button. When you are using the password to open the door. Press this button once to begin input. After you input the password, please press it again to complete the operation.</li> <li>4.  Call button. After you input the room number, press it to begin a dial up.</li> <li>5.  Call MGT center button. Press it to call the MGT center directly.</li> </ol>
7	Card Induction zone	Use the card to open the door.
8	LCD	<p>Here you can view prompt information, date, time and etc.</p> <p>Note:</p> <ol style="list-style-type: none"> <li>1. "Call: Room No. +  ". Please input the room number first and then press the button  to dial;</li> <li>2. "Center: Press  button". Please press the button  to call the MGT center.</li> <li>3. "Unlock: # + password + # ", If you want to open the door via the password, please press the button # and then input the room number and password. Please press the button # to confirm.</li> </ol>
9	Camera	It is to monitor the video of the door.



## 2 Basic Functions



### 2.1 Call MGT center

In the standby status (错误! 未找到引用源。 , Figure 1- 2), press  or  button, this VTO will call the MGT center. The video door phone begins when the MGT Port picks up.

During the whole process, you can press the button  or \* to end current dialogue and return to the standby interface.

### 2.2 Call Users

#### 2.2.1 Call Status

In the standby status, input the room number and then press the button  or  , you can generate a call to the VTH of the user. During the process, you can press the button  or \* to end current dialogue and return to the standby interface.

#### 2.2.2 Communication status

After you generated a call to the VTH, if there is response, you can enter communication status. It can realize the dual-way video phone. During the process, you can press the button  or \* to end current dialogue and return to the standby interface.

### 2.3 Monitor Function

The MGT Port and the VTH can both enable the monitor function which turns on the camera and monitors the device video.

## **2.4 Unlock Function**

### **2.4.1 Unlock During the Dial Process**

During the dial process, the MGT Port or the VTH can open the door lock of the device remotely. System returns to the standby interface after phone hangs up or the countdown is complete.





### **2.4.2 Unlock During the Communication**

During the communication process, the MGT Port or the VTH can open the door lock of the device remotely. System returns to the standby interface after phone hangs up or the countdown is complete.

### **2.4.3 Unlock During the MON**

During the MON, the MGT Port or the VTH can open the door lock of the device remotely. System returns to the standby interface after phone hangs up or the countdown is complete.

### **2.4.4 Unlock via the Password**

In the standby status, press the button  or  and then input the room number and password. Press the button  or  to confirm the operation. The door is open if the password authentication is OK.

### **2.4.5 Unlock via IC card**

The door is open after you swipe IC card and the card passed the authentication and station verification.

## **2.5 Environment Light Compensation Function**

This device has the light compensation function when it is in the low illumination environments or it is at night. It includes the LCD backlight and the camera compensation light.

## **2.6 Access Control (A&C) Function**

The device can connect 1-channel door sensor input. It can be used to detect door status. There is 1-channel door on-off button to open/close the door.

It has 2-channel control output. There are two modes: NO/NC. It can also be used for other general controls. Please refer to later sections for detailed information.

## **2.7 Vandal Proof Function**

There is 1-channel vandal proof button. System can generate an alarm once it is removed from the wall. At the same time, it can upload the alarm information to the MGT center.

## **2.8 Approaching Induction**

Only VTO1220A and VTO1210B-X have this function. When there is any body approaching the VTO at a distance about 1 meter, screen backlight will be ON.

# **3 Web Function**

## **3.1 Overview**

The web-based interface is shown in Figure 3- 1.

Web function supports VTO1220, VTO1210A-X and VTO1210B-X. Here makes 1210B-X an example:

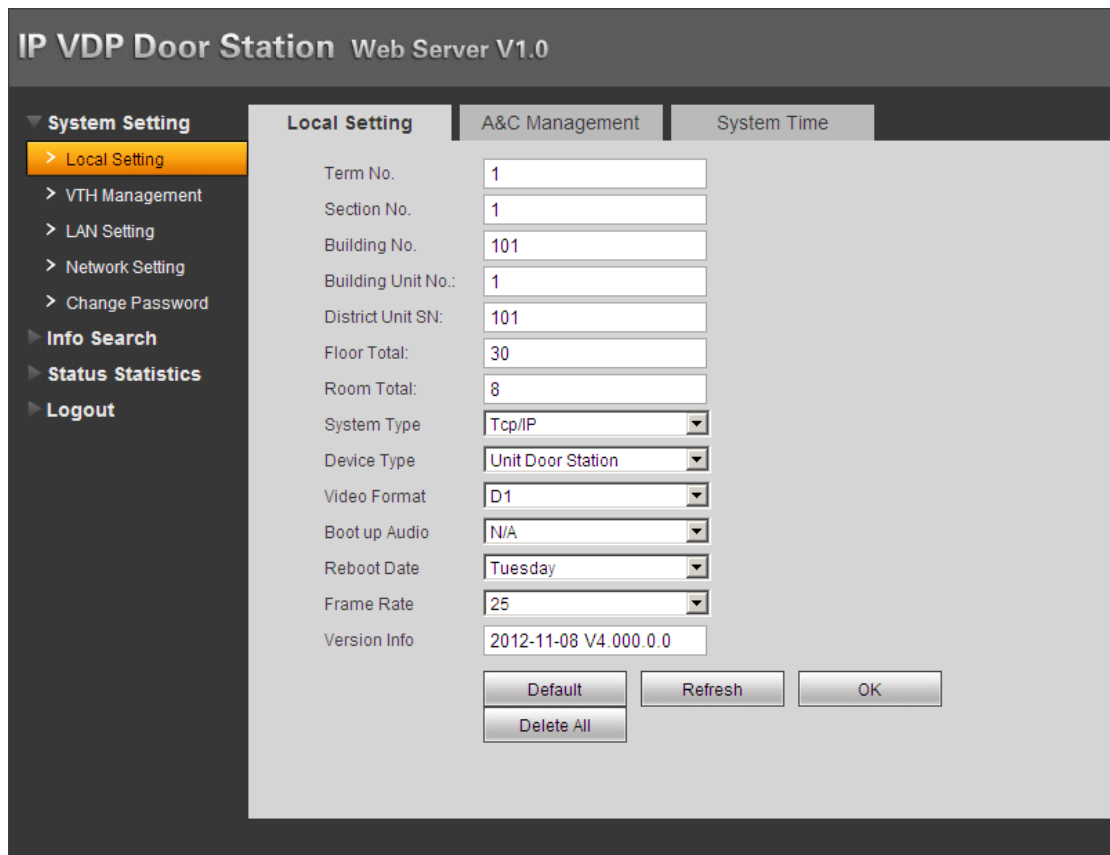

Figure 3- 1

Please refer to the following sheet for detailed information.

SN	Name	Function
1	System Settings	You can set VTO1210B-X device parameter and network info.
2	Info Search	You can search VTO1210B-X call history.
3	Status Statistics	You can perform statistics of VTH status under VTO1210B-X.
4	Logout	You can control reboot of VTO1210B-X and shutdown of WEB server.

## 3.2 Basic Functions

### 3.2.1 Login Interface

Input VTO IP address in address field of IE Explorer as in Figure 3- 2.



Figure 3- 2

You must input username and password in order to login WEB main interface.

Default username: admin

Default password: admin.

After you login, you will see 4 major settings: system, info search, status statistics, and Logout.

### 3.2.2 System Settings

System settings includes: local, VTH management, networking, network and password change.

#### 3.2.2.1 Local Setting

The following is the instruction for major settings:

1. Frame: For NTSC standard, please select 30 frame/s. For Pal standard, please select 25 frame/s.
2. One-key clear: You may restore all settings on VTO to default after pressing this button and confirm. **Be careful!**
3. Video format has two types of resolution:
  - D1: 704x576
  - WVGA: 800x480

Please see Figure 3- 3.

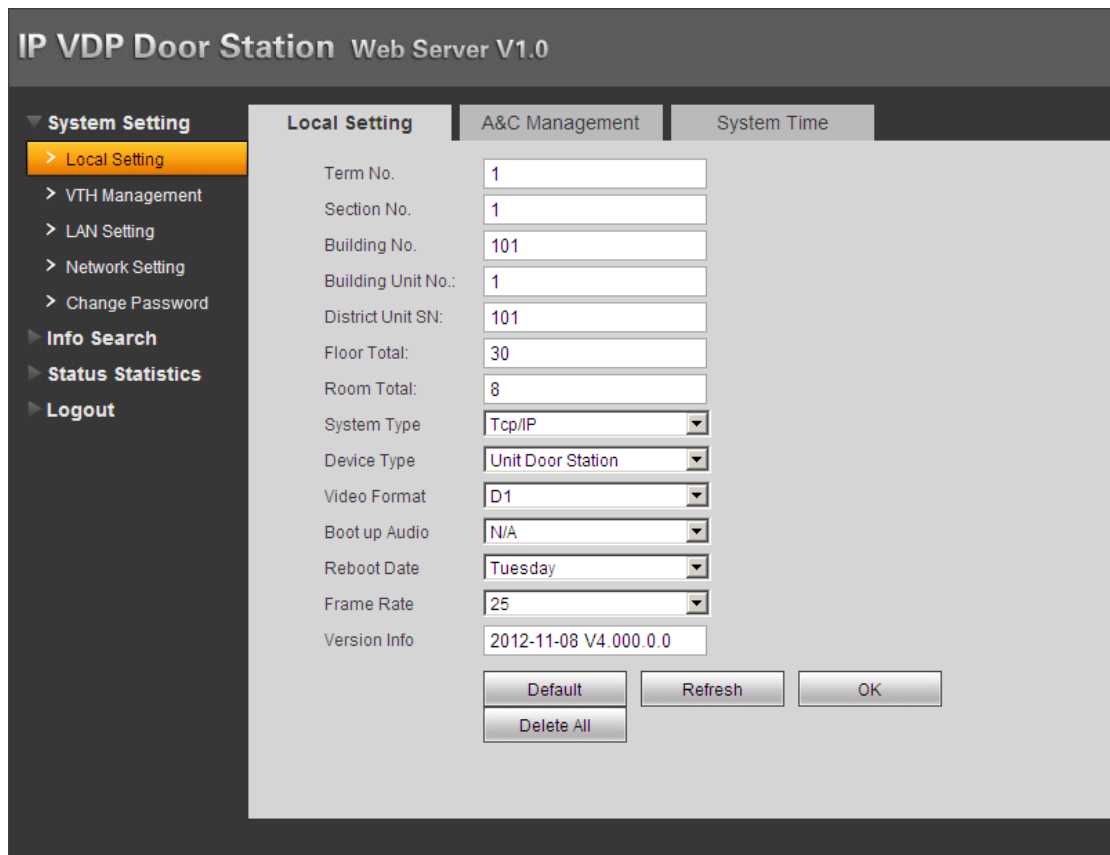

Figure 3- 3

### 3.2.2.2 Access Control Management

Click on *local setting* and then click on *access control management*. You may change password here and please keep in mind that the initial password is 123456. To unlock door, please input #123456#. You also can set unlock interval and duration. FTP address: FTP address is used to store snapshot taken at VTO when someone swipes card. User can login FTP to view those photos.

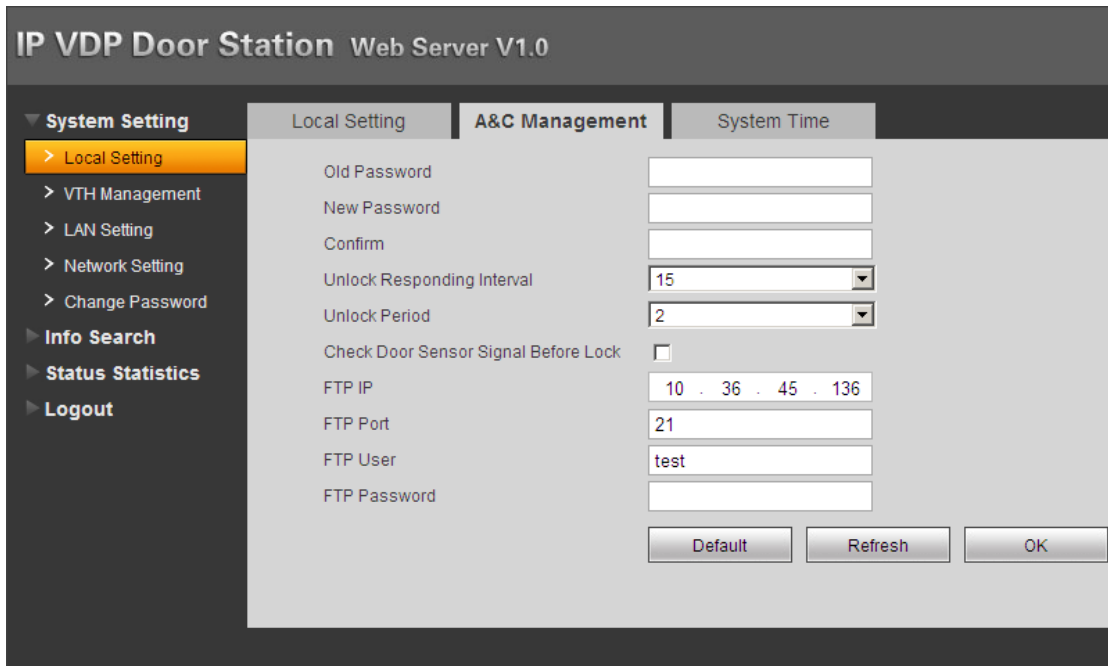

Figure 3- 4

### 3.2.2.3 System Time

Click on *local setting* and then click on *system time*. You may set time in the following interface as in Figure 3- 5. You may also synchronize system time with your local PC.

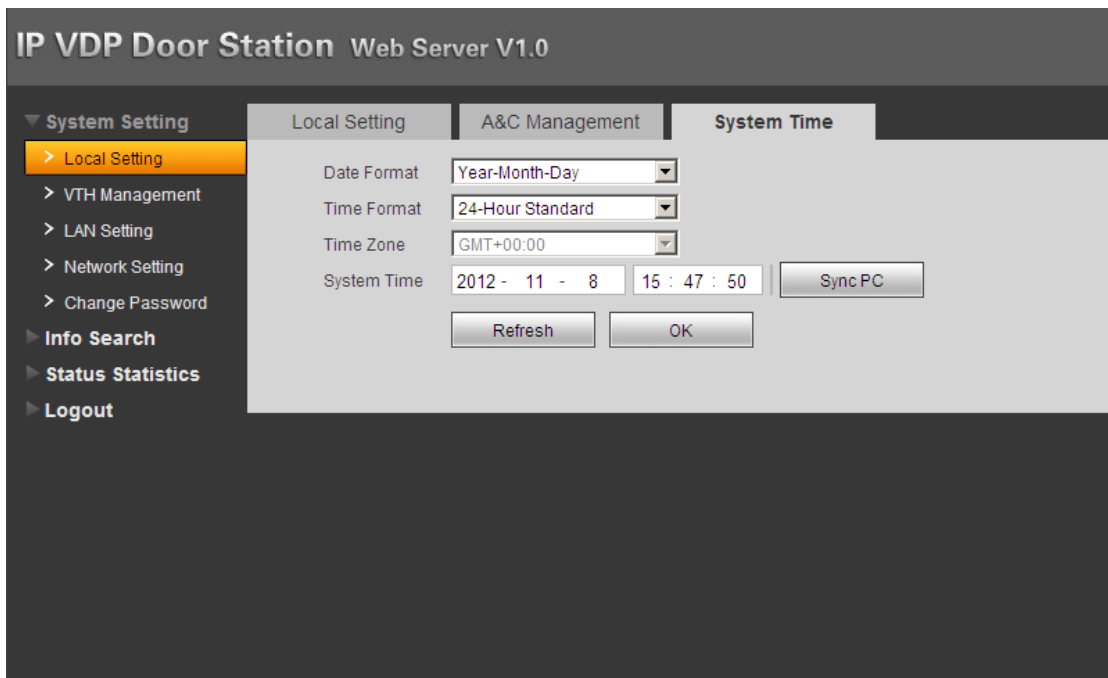

Figure 3- 5

### 3.2.3 VTH Management

VTH management mainly includes add digital/analog VTH, delete VTH and edit VTH user.

#### 3.2.3.1 Digital VTH Management

In digital VTH management interface, check box *display resident info enable* to display successfully configured VTH info as shown in Figure 3- 6. Click on *add* button at the left lower corner, and input user name and VTH number. Please be notified that only VTH number is required for operation as default.

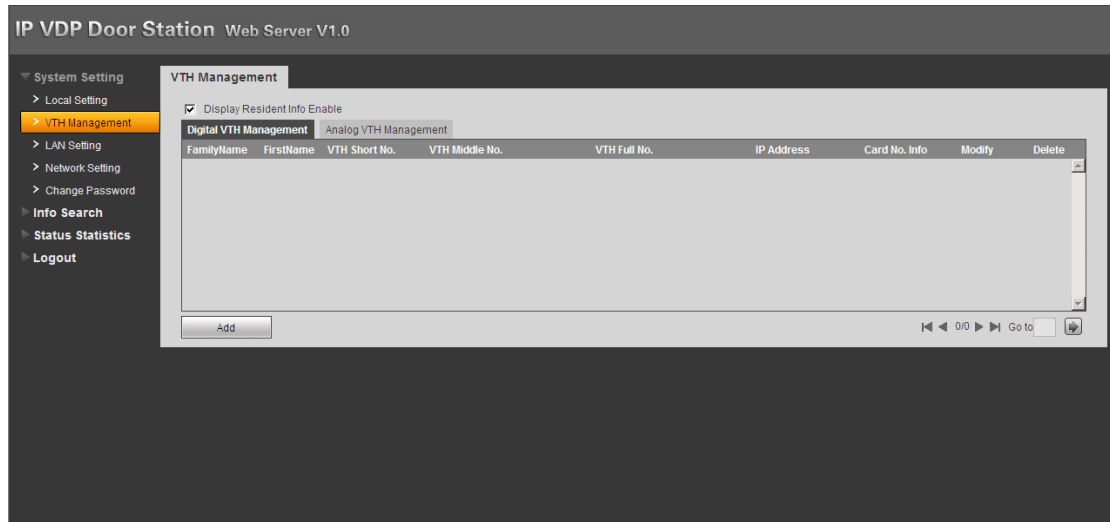

Figure 3- 6

#### 3.2.3.2 Analog VTH Management

In analog VTH management interface, check box *display resident info enable* to display successfully configured VTH info as shown in Figure 3- 7. Click on *add* button at the left lower corner, and input VTH number, distributor address and distributor port. VTH number is the room number where analog VTH locates; distributor address is its dialup IP which ranges from 1 to 99. It originally could be manually adjusted, but now it has been burned into program. Port is the corresponding port number in distributor which normally is either 1~4 or 1~8, depending on number of distributor channel. For example, room number is 1502, distributor address is 15, and port NO. is 2.



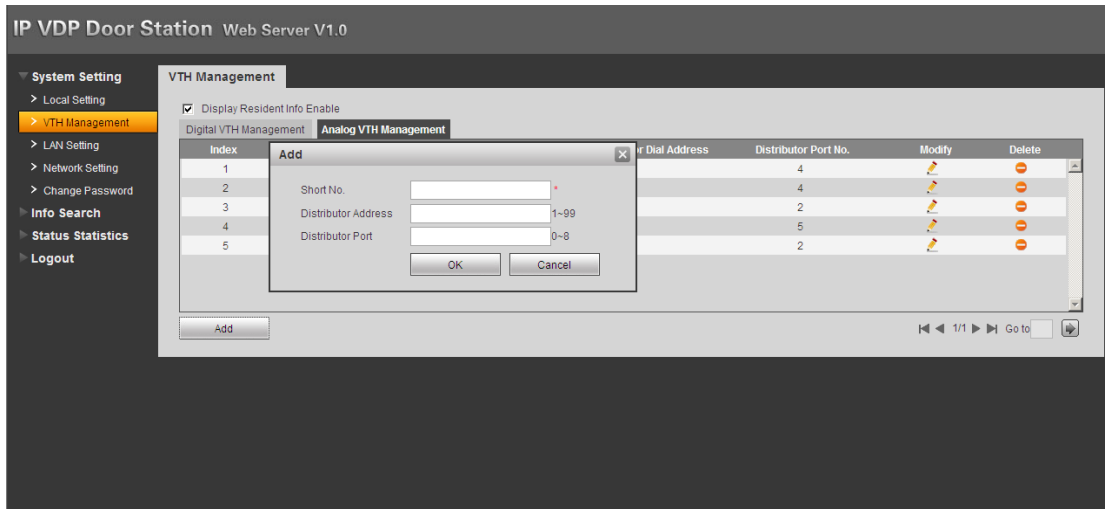

Figure 3- 7

### LAN Setting

Default setting is enough if you just want networking between VTO and VTH, but if you want to set MGT center, you need to change default settings to be identical with MGT center info. You also need to check box *register to the MGT center*.

If you successfully set MGT center, you may call MGT center by pressing *call MGT center* button at lower left corner on VTO. Please see Figure 3- 8.

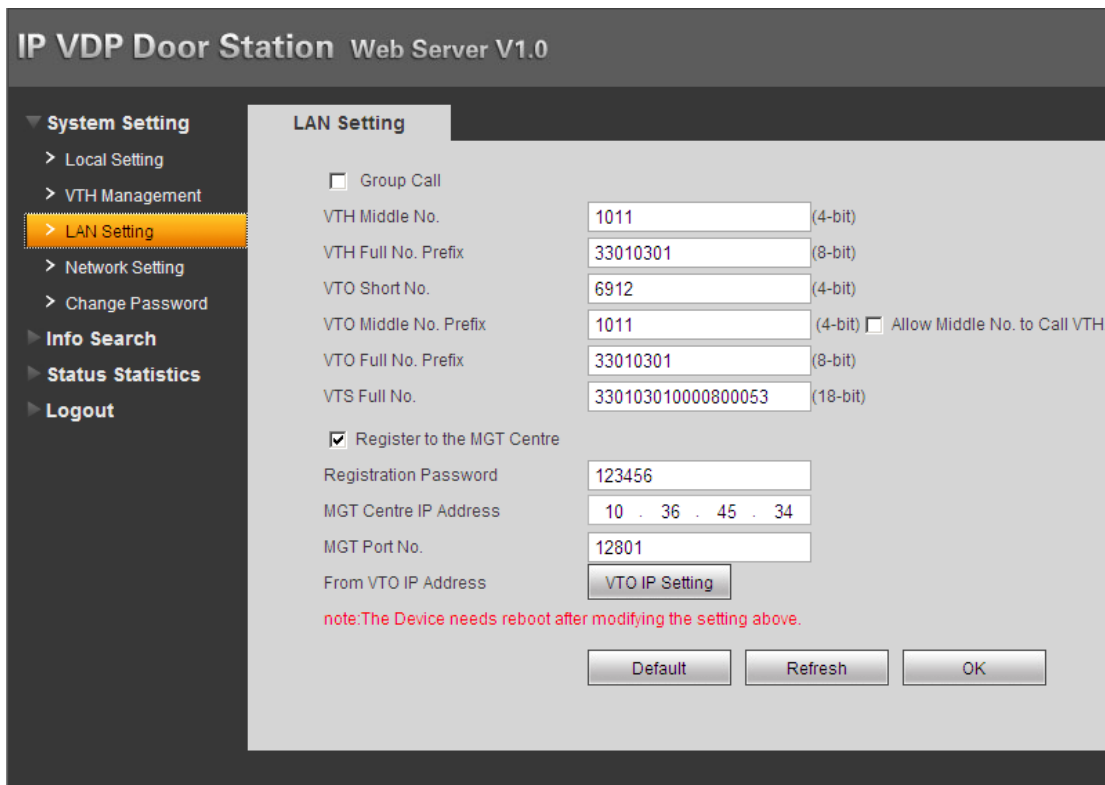

Figure 3- 8

### Network Setting

In network setup interface, you can set IP parameter, IP address, subnet mask and default gateway of VTO as shown in Figure 3- 9. After you change IP address, WEB interface will reboot and you will see a new IP address interface.

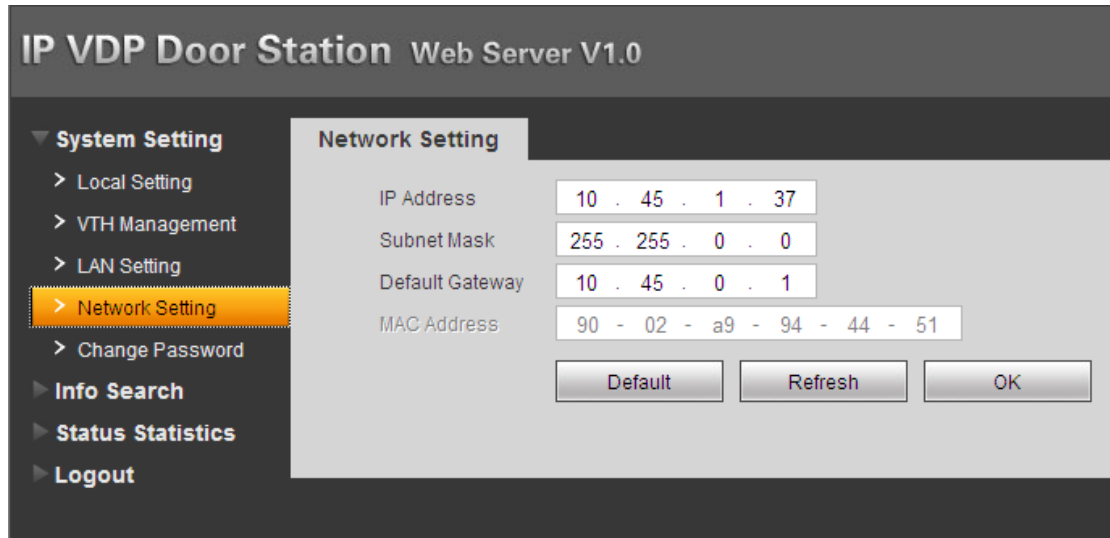

Figure 3- 9

### Change Password

In password change interface, you can change WEB login password of VTO. You must input old password, new password and confirm new password. Click on *OK* button to save as shown in Figure 3- 10.

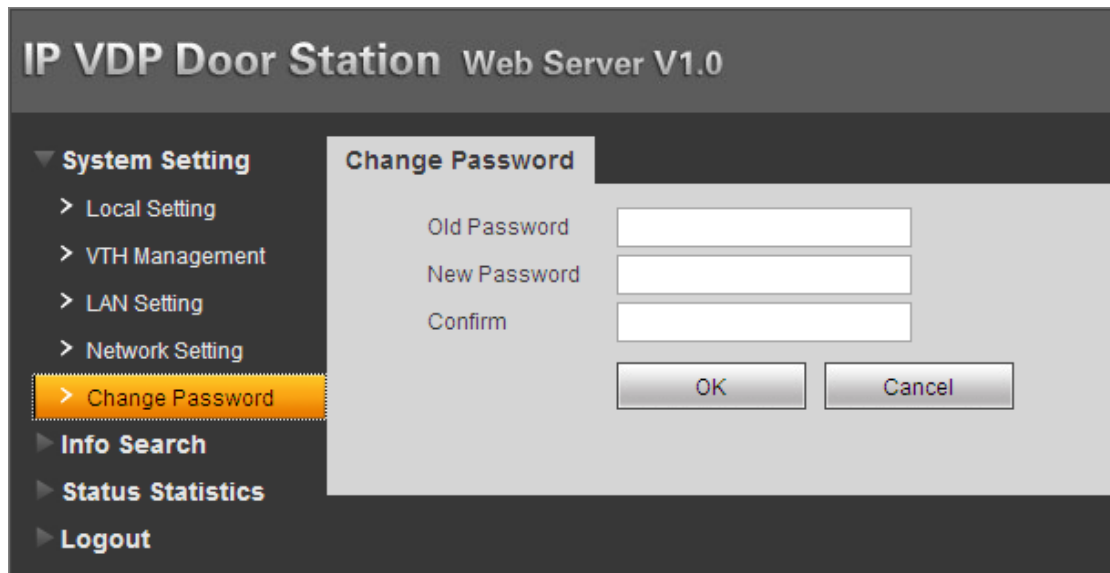

Figure 3- 10

### Info Search

Click on *info search* and then click on *card history*. Here you may search local call histories and device can store up to 1124 records. Please see Figure 3- 11

IP VDP Door Station Web Server V1.0

System Setting  
Info Search  
Call History  
Status Statistics  
Logout

VTO Call History

Index	Call Type	Room No.	Start Time	Call Duration(m)	End Status
1	Outgoing	303	2012:11:07 15:02:49	00:02	Received
2	Outgoing	8000	0	00:00	Missed
3	Outgoing	8000	0	00:00	Missed
4	Outgoing	203	2012:11:08 13:20:12	00:12	Received
5	Outgoing	8000	0	00:00	Missed
6	Outgoing	203	2012:11:08 08:15:21	00:11	Received
7	Outgoing	303	2012:11:05 18:55:36	00:04	Received
8	Outgoing	9999	0	00:00	Missed
9	Outgoing	203	2012:10:31 15:19:01	00:11	Received
10	Outgoing	203	2012:10:31 15:18:15	00:12	Received
11	Outgoing	203	2012:10:31 15:17:08	00:10	Received

1/28 Go to

Figure 3- 11

### Status Statistics

Click on *status statistics* and then click on *VTH status*. Here you can view connection status of VTH as shown in Figure 3- 12.

IP VDP Door Station Web Server V1.0

System Setting  
Info Search  
Status Statistics  
VTH Status  
Logout

VTH Status

VTH	Status	MON	IP:PORT	REG_TIME	OFFTIME
203	Offline	Unmon	2.4	0	0
303	Online	Unmon	2.2	2012:11:08 15:45:11	0
304	Offline	Unmon	2.5	0	0
403	Offline	Unmon	2.2	0	0
9999	Offline	Unmon	2.4	0	0

1/1 Go to

Figure 3- 12

### Logout

Click on *Logout*. Here you may select either to reboot device or Logout system as shown in Figure 3- 13 and Figure 3- 14.

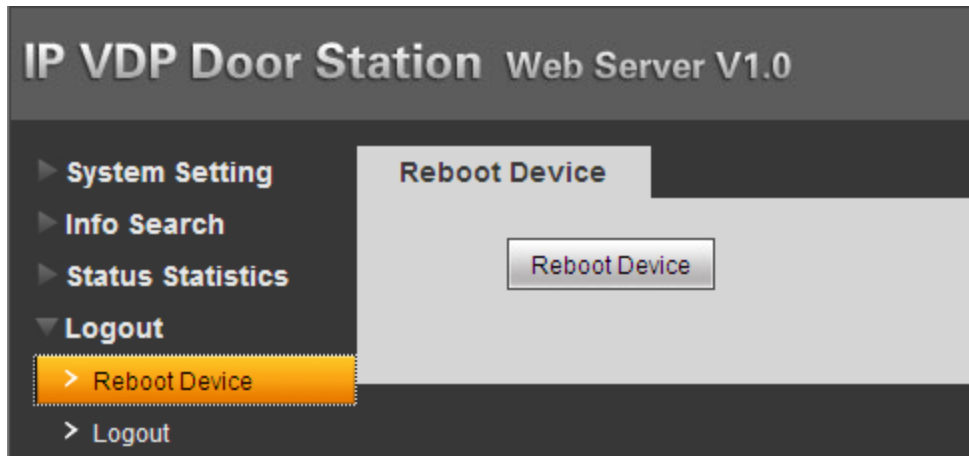

Figure 3- 13

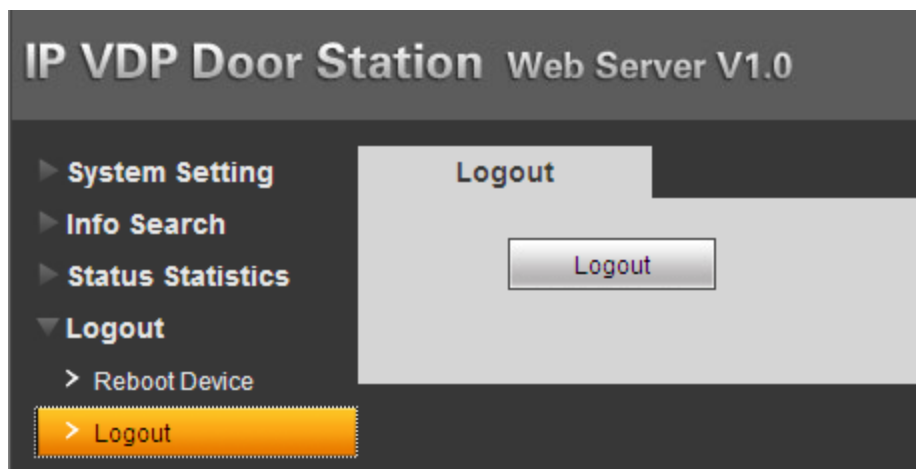

Figure 3- 14

## 4 Specifications

Model	VTO1210A	VTO1220A	VTO1210A-X	VTO1210B-X
OS				
Main Processor	Embedded micro processor			
OS	Embedded LINUX OS			
Video				
Video Compression Standard	H.264			
Input/Approaching Induction	1.3 megapixel CMOS camera			
Back Light	Support			
Auto Light Compensation	Support			
Audio				
Input	Microphone			

Output	Built-in speaker			
Bidirectional Talk	Support dual-way bidirectional talk			
Display				
LCD Dimensions	3-inch STN screen	3.5-inch TFT screen	3-inch STN screen	3-inch STN screen
Resolution	128*64	320*240	128*64	128*64
Operation Mode				
Input	Digital keyboard	Digital keyboard	Digital keyboard	Touch keyboard
Card	Built-in IC card induction reader			
Approaching Induction				
Body Approaching	Not applicable	1 meter	Not applicable	1 meter
Alarm				
Vandal proof	Support			
Access Control				
NO Output	Support			
NC Output	Support			
Door on/off Button	Support			
Door Status Detect	Support			
Network				
Ethernet	10M/100Mbps Self-adaptive			
Network Protocol	TCP/IP			
Storage				
Memory	128MB			
Others				
Power	DC 10~15V			
Power Consumption	Standby≤1W ; work≤10W			
Working Environments	-10℃~+60℃	-20℃~+60℃	-10℃~+60℃	-40℃~+60℃
	10~95%RH			
Water Proof	VTO1212B-X Water proof level:IP65			
Dimensions	376mm*151mm*60mm (L*W*H)			
Weight	1.6kg			

## 5 Device Port

The device rear panels are shown as in [错误！未找到引用源。](#) and Figure 5- 2.

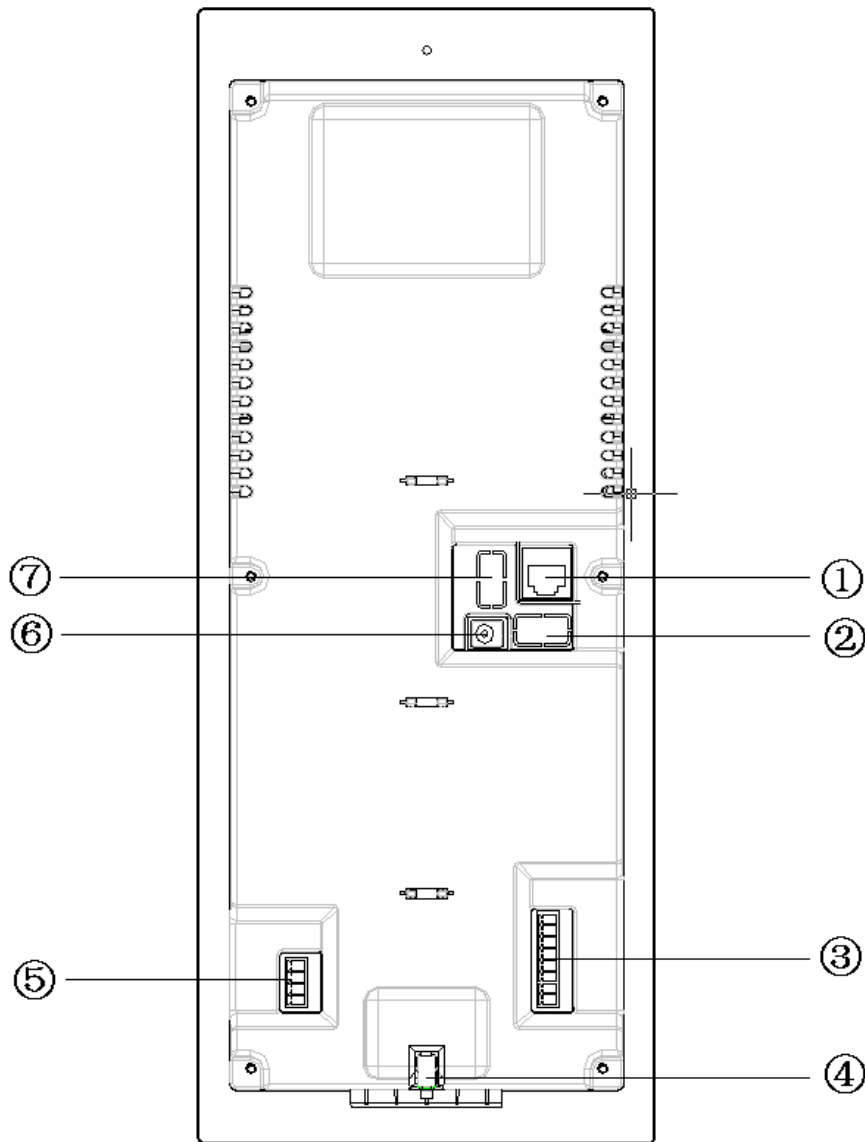
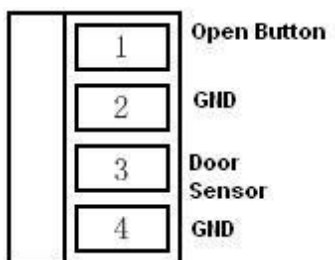

Figure 5- 1 VTO1210A/VTO1220A/VTO1210A-X rear structure

Please refer to the following sheet for detailed information.

SN	Port Name	Function
1	Network Port	Connect to the RJ45 port.
2	Access Control Input Port	Connect to signal from the door sensor, door on/off signal. 
3	Analog Signal Port (VTO1210A-X only)	Connect to the analog signal of the distributor.

4	Vandal Proof Alarm Button	It can generate an alarm when there is a vandal operation.
5	RS422 Port (Reserved)	<p>Connect to RS422 or RS485 Communication Device.</p>
6	Power Port	Connect to 12V DC.
7	Access Control Output Port	<p>Control NO/NC of door lock.</p>

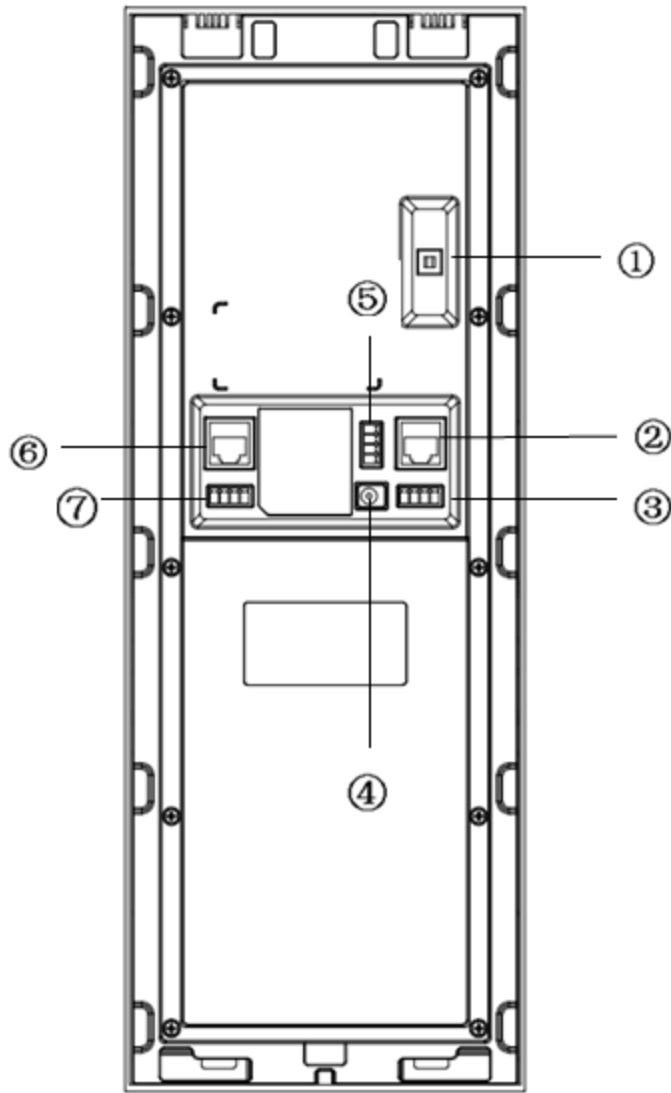

Figure 5- 2 VTO1210B-X rear structure

Please refer to the following sheet for detailed information.

SN	Port Name	Function
1	Vandal Proof Alarm Button	It can generate an alarm when there is a vandal operation.
2	Network Port	Connect to the RJ45 port.
3	Access Control Input Port	Connect to signal from the door sensor, door on/off signal.



4	Power Port	Connect to 12V DC power.
5	Access Control Output Port	<p>Open or close the NO/NC lock.</p>
6	Analog Signal Port	Connect to the analog signal of the distributor.
7	RS485 Port	<p>Connect to RS422 or RS484 communication device.</p>

## 6 Installation

Please refer to the following sheet for detailed installation information. Please see Figure 6- 1 and Figure 6- 2 VTO1210B-X installation guide.

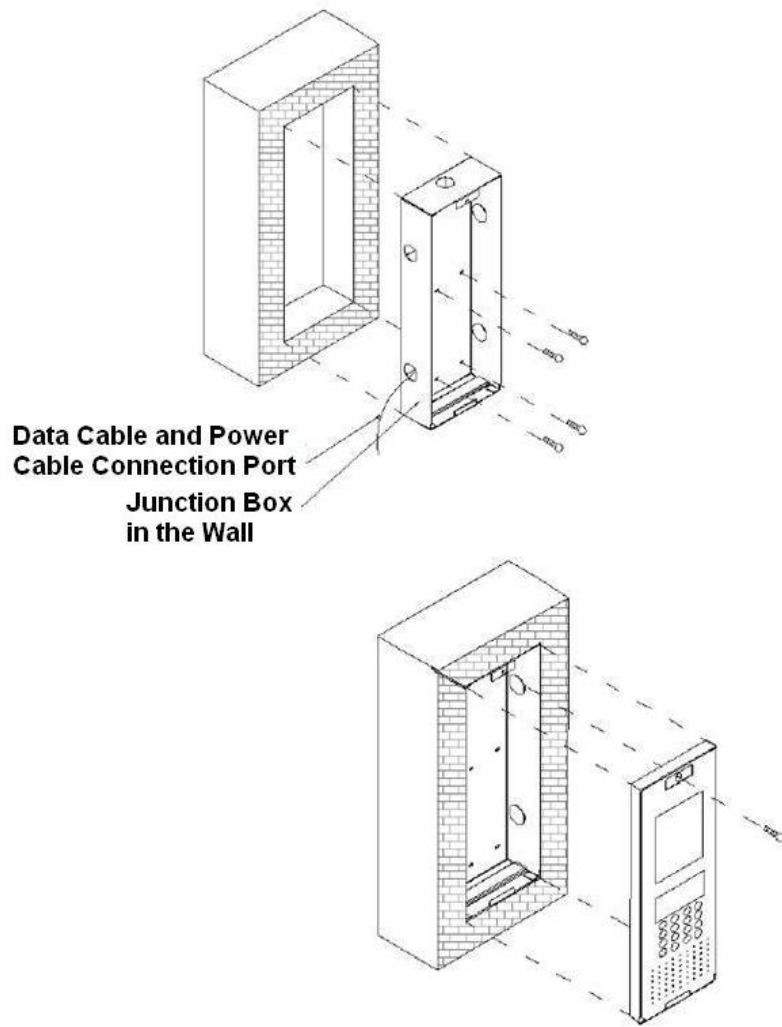

Figure 6- 1 VTO1210A/VTO1210A-X/VTO1220A installation guide

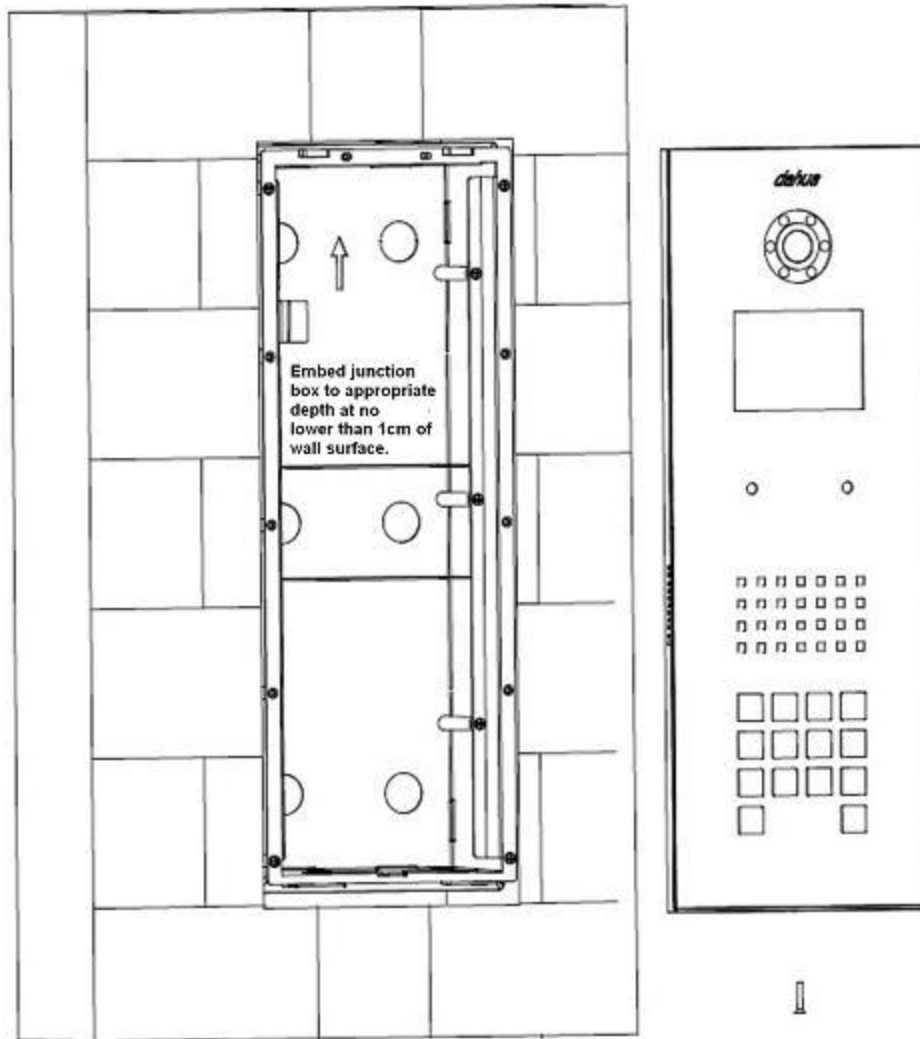

Figure 6- 2 VTO1210B-X installation guide

## 7 FAQ

Q: I cannot boot up the device, or I can see the LCD is black.

A: Please check your power cable connection. Please reboot it again.

Q: I cannot call.

A: Please check your network connection.

Q: I cannot reach the person I want to contact. What shall I do?

A: It may be the network error. Please check the network cable connection between the host and the extension device.

Q: The number I dial does not exist.

A: Please make sure you have dialed the proper number.

Q: System says the IC card number is invalid when I swipe the card. What shall I do?

A: The card status is abnormal. Please contact your administrator for help.

Q: System says the IC card number is wrong. What shall I do?

A: It means current card does not have the authority. Please contact your administrator for help.

Q: I have some problems, I am not so sure or I can not fix.

A: Please contact your local retailer for help.

Note:

This manual is for reference only. Slight difference may be found in user interface.

All the designs and software here are subject to change without prior written notice.

**All trademarks and registered trademarks are the properties of their respective owners.**

If there is any uncertainty or controversy, please refer to the final explanation of us.

Please visit our website or contact your local service engineer for more information.