



# **Dahua Intelligent Video Surveillance Server User's Manual**

**V 1.0.1**

# Table of Contents

1	Features and Specifications .....	1
1.1	Overview.....	1
1.2	Features.....	1
1.3	Structure .....	3
1.3.1	Front Panel.....	3
1.3.2	Rear Panel.....	8
2	Installation and Connection .....	15
2.1	Installation Flows.....	15
2.2	Unpacking.....	15
2.3	HDD Installation.....	16
2.3.1	12-HDD Series.....	16
2.3.2	16/24-HDD Series .....	17
2.4	Cable Connection.....	17
3	Before the Start .....	19
3.1	Mouse Operation.....	19
3.2	Virtual Keyboard.....	19
3.3	Menu Item.....	21
4	Start-Up .....	23
4.1	Boot up.....	23
4.2	Device Initialization .....	23
4.3	Quick Settings.....	25
4.3.1	System Time.....	25
4.3.2	IP Address .....	26
4.3.3	P2P.....	28
4.4	Register Remote Device .....	29
4.4.1	Short-Cut Menu .....	29
4.4.2	Manual Add .....	35
5	Operations.....	40
5.1	Login IVSS .....	40
5.2	Preview and Monitor .....	42
5.2.1	View Management.....	43
5.2.2	Resources Tree .....	53
5.2.3	PTZ.....	55
5.2.4	Preview .....	60
5.3	Search.....	63
5.3.1	Playback Record File.....	63
5.3.2	Clip Footages.....	67
5.3.3	Playback Image .....	69
5.3.4	Export File.....	71
5.4	Alarm List.....	74
5.5	Display .....	74
5.5.1	Multiple-Screen Control .....	74
5.5.2	Lock Displayer .....	76

5.6	File.....	76
5.6.1	Configuring Human Face Database.....	76
5.6.2	Managing Human Face Image.....	86
5.6.3	Deleting Human Face Database.....	87
5.7	Intelligent Analytics.....	87
5.8	System Info.....	90
5.9	Background Task.....	91
5.10	Operation and Maintenance Management.....	91
5.10.1	Search Log.....	92
5.10.2	Online User.....	95
5.10.3	Device Maintenance.....	96
6	System Configuration.....	101
6.1	Configuring Interface.....	101
6.2	Device Manager.....	101
6.2.1	Local Device.....	102
6.2.2	Register.....	104
6.3	Network.....	120
6.3.1	Basic Network.....	120
6.3.2	Network Applications.....	128
6.4	Event.....	132
6.4.1	Local device.....	132
6.4.2	Remote Device.....	137
6.5	Storage.....	149
6.5.1	Physical HDD.....	149
6.5.2	RAID.....	153
6.6	Account.....	160
6.6.1	User group.....	161
6.6.2	Device User.....	162
6.6.3	ONVIF.....	165
6.7	Security Strategy.....	167
6.7.1	HTTPS.....	167
6.7.2	IP Filter.....	172
6.7.3	Safety Protection.....	174
6.8	System Manager.....	176
6.8.1	Parameters.....	176
6.8.2	Time.....	177
6.8.3	Display.....	178
6.8.4	Calendar.....	179
6.9	Logout/Reboot/Shut down.....	180
7	WEB.....	181
8	IVSS Browser Introduction.....	183
8.1	IVSS browser.....	183
8.2	Login IVSS browser.....	185
8.3	History record.....	186
8.4	About IVSS.....	187
9	Appendix 1 FAQ.....	188

10	Appendix 2 Glossary.....	189
11	Appendix 3 RAID.....	191
11.1	About RAID .....	191
11.2	RAID Level .....	191
11.3	RAID Capacity .....	191
12	Appendix 4 HDD Capacity Calculation .....	193



## Welcome

Thank you for purchasing our intelligent video surveillance server (IVSS)!

This user's manual is designed to be a reference tool for your system.

Please open the accessory bag to check. Contact your local retailer ASAP if something is missing or damaged in the bag.

## Trademark

- VGA is the trademark of IBM.
- Windows logo and Windows are trademarks or registered trademarks of Microsoft.
- Other trademarks and company names mentioned are the properties of their respective owners.

## About this Document

- This document is for reference only. Please refer to the actual product for more details.
- This document serves as a reference for multiple types of products, whose specific operations will not be enumerated. Please operate according to actual products.
- The user shall undertake any losses resulting from violation of guidance in the document.
- In case that PDF document cannot be open, please upgrade the reading tool to the latest version or use other mainstream reading tools.
- This company reserves rights to revise any information in the document anytime; and the revised contents will be added to the new version without prior announcement. Some functions of the products may be slightly different before and after revision.
- The document may include technically inaccurate contents, inconsistencies with product functions and operations, or misprint. Final explanations of the company shall prevail.

# Cybersecurity Recommendations

## Cybersecurity Recommendations

### Mandatory actions to be taken towards cybersecurity

#### 1. Change Passwords and Use Strong Passwords:

The number one reason systems get “hacked” is due to having weak or default passwords. It is recommended to change default passwords immediately and choose a strong password whenever possible. A strong password should be made up of at least 8 characters and a combination of special characters, numbers, and upper and lower case letters.

#### 2. Update Firmware

As is standard procedure in the tech-industry, we recommend keeping NVR, NVR, and IP camera firmware up-to-date to ensure the system is current with the latest security patches and fixes.

### “Nice to have” recommendations to improve your network security

#### 1. Change Passwords Regularly

Regularly change the credentials to your devices to help ensure that only authorized users are able to access the system.

#### 2. Change Default HTTP and TCP Ports:

- Change default HTTP and TCP ports for systems. These are the two ports used to communicate and to view video feeds remotely.
- These ports can be changed to any set of numbers between 1025-65535. Avoiding the default ports reduces the risk of outsiders being able to guess which ports you are using.

#### 3. Enable HTTPS/SSL:

Set up an SSL Certificate to enable HTTPS. This will encrypt all communication between your devices and recorder.

#### 4. Enable IP Filter:

Enabling your IP filter will prevent everyone, except those with specified IP addresses, from accessing the system.

#### 5. Change ONVIF Password:

On older IP Camera firmware, the ONVIF password does not change when you change the system’s credentials. You will need to either update the camera’s firmware to the latest revision or manually change the ONVIF password.

#### 6. Forward Only Ports You Need:

- Only forward the HTTP and TCP ports that you need to use. Do not forward a huge range of numbers to the device. Do not DMZ the device's IP address.

- You do not need to forward any ports for individual cameras if they are all connected to a recorder on site; just the NVR is needed.

#### **7. Disable Auto-Login on SmartPSS:**

Those using SmartPSS to view their system and on a computer that is used by multiple people should disable auto-login. This adds a layer of security to prevent users without the appropriate credentials from accessing the system.

#### **8. Use a Different Username and Password for SmartPSS:**

In the event that your social media, bank, email, etc. account is compromised, you would not want someone collecting those passwords and trying them out on your video surveillance system. Using a different username and password for your security system will make it more difficult for someone to guess their way into your system.

#### **9. Limit Features of Guest Accounts:**

If your system is set up for multiple users, ensure that each user only has rights to features and functions they need to use to perform their job.

#### **10. UPnP:**

- UPnP will automatically try to forward ports in your router or modem. Normally this would be a good thing. However, if your system automatically forwards the ports and you leave the credentials defaulted, you may end up with unwanted visitors.
- If you manually forwarded the HTTP and TCP ports in your router/modem, this feature should be turned off regardless. Disabling UPnP is recommended when the function is not used in real applications.

#### **11. SNMP:**

Disable SNMP if you are not using it. If you are using SNMP, you should do so only temporarily, for tracing and testing purposes only.

#### **12. Multicast:**

Multicast is used to share video streams between two recorders. Currently there are no known issues involving Multicast, but if you are not using this feature, deactivation can enhance your network security.

#### **13. Check the Log:**

If you suspect that someone has gained unauthorized access to your system, you can check the system log. The system log will show you which IP addresses were used to login to your system and what was accessed.

#### **14. Physically Lock Down the Device:**

Ideally, you want to prevent any unauthorized physical access to your system. The best way to achieve this is to install the recorder in a lockbox, locking server rack, or in a room that is behind a lock and key.

#### **15. Connect IP Cameras to the PoE Ports on the Back of an NVR:**

Cameras connected to the PoE ports on the back of an NVR are isolated from the outside world and













cannot be accessed directly.

#### **16. Isolate NVR and IP Camera Network**

The network your NVR and IP camera resides on should not be the same network as your public computer network. This will prevent any visitors or unwanted guests from getting access to the same network the security system needs in order to function properly.

## Safety Instruction

Icon	Note
 DANGER	Indicates a hazard with a high level of risk, which if not avoided, will result in death or serious injury.
 WARNING	Indicates a potentially hazardous situation, which if not avoided, could result in serious device damage or person injury.
 CAUTION	Indicates a potentially hazardous situation, which if not avoided, could result in device damage, data loss, performance degradation, or unexpected results.
 Anti-static	Indicates it is the static sensitive device.
 Electric shock risk	Indicates presence of dangerous high voltage. There is a risk of electric shock to persons.
 High power laser radiation risk	Indicates presence of high power laser radiation.
 <b>Tips</b>	It is intended to help you to fix a problem or save your time.
 <b>Note</b>	Provides additional information to emphasize or supplement important points of the main text.

### About this manual

- Device or system refers to intelligent video surveillance server (IVSS) or IVSS system if not otherwise specified.
- The remote device in this manual refers to the devices connected to the IVSS via the network such as network video recorder (NVR), IPC(IP camera or network camera), or PTZ camera (speed dome).
- The AI module refers to the intelligent card installed on the IVSS device.
- The IP host refers to the host that has configured the IP address. It includes personal computer (PC), NVR, IPC (IP camera or network camera),or PTZ camera (speed dome).
- The device supports local menu, WEB, IVSS browser operations. The figures listed below are mainly based on the local menu. Slight different maybe found on the user interface if you are using WEB or IVSS browser to access the device. Refer to the actual products for detailed information.
- For privacy consideration, the personnel information such as human face, plate number in this manual is covered with digital mosaics.

## Revision History

SN	Version No.	Revision Contents
1	V1.0.0	Initial release
2	V1.0.1	Updating some figures. Adding P2P function. Changing intelligent preview, storage schedule function description. Optimizing some description and operations.

## Important Safeguarding and Warnings

The following description is the correct application method of the device. Please read the manual carefully before use, in order to prevent danger and property loss. Strictly conform to the manual during application and keep it properly after reading.

### Operating Requirements

- Do not place and install the device in an area exposed to direct sunlight or near heat generating device.
- Do not install the device in a humid, dusty or fuliginous area.
- Please keep its horizontal installation, or install it at stable places, and prevent it from falling.
- Do not drip or splash liquids onto the device; do not put on the device anything filled with liquids, in order to prevent liquids from flowing into the device.
- Please install the device at well-ventilated places; do not block its ventilation opening.
- Use the device only within rated input and output range.
- Do not dismantle the device arbitrarily.
- Please transport, use and store the device within allowed humidity and temperature range.

### Power Requirement

- Please make sure to use batteries according to requirements; otherwise, it may result in fire, explosion or burning risks of batteries!
- To replace batteries, only the same type of batteries can be used!
- The product shall use electric cables (power cables) recommended by this area, which shall be used within its rated specification!
- Please make sure to use standard power adapter supplied with the device, or the user shall undertake resulting personal injuries or device damages.
- Please use power supply that meets SELV (safety extra low voltage) requirements, and supply power with rated voltage that conforms to Limited Power Source in IEC60950-1. For specific power supply requirements, please refer to device labels.
- Products with category I structure shall be connected to grid power output socket, which is equipped with protective grounding.
- Appliance coupler is a disconnecting device. During normal use, please keep an angle that facilitates operation.

### Caution

**DO NOT CHANGE OR REPLACE THE AI MODULE WHEN DEVICE IS RUNNING.** Shut down the device first and then remove the AI module, otherwise, the data on the AI module may result in damage.

# 1 Features and Specifications

## 1.1 Overview

Intelligent video surveillance server is a product of new form. Compatible with the general functions of video surveillance of security industry, it has added AI functions such as human face recognition, features extraction based on the deep learning technology.

This series product includes general system settings, video surveillance, video storage, alarm settings, log management, record search and playback, intelligent analysis (such as human face real-time recognition, search human face by specified image and then playback video). This series product has user-friendly interface, suitable for user to operate. At the same time, it supports real-time alarm and search record file or image by human face features, which greatly enhance record file search speed.

This series product supports 4K and H.265 decode, it meets the main development trend of current market.

This series product can be widely used in the intelligent building, large parking lot, safe city project, financial planning area, etc.

## 1.2 Features

This chapter is to introduce main functions of the product.

- Device management
  - Connect to the product from the 3rd-party via ONVIF, AXIS, SONY protocol etc.
  - Use manufacturer, IP filter to narrow search range.
  - Initialize remote device, modify remote device name, IP address ,etc.
  - Add remote device on the background.
  - Remote device encode settings, OSD settings, etc.
- Network management
  - Four 10/100/1000Mbps self-adaptive network ports.
  - Load balance, fault-tolerance, link aggregation working mode.
  - WEB access to visit or manage the device remotely.
  - TCP, UDP, HTTP, HTTPS transmission.
- Storage
  - Get HDD slot status, HDD model, space, running status.
  - HDD Cleanup to enhance HDD whole performance and running speed.
  - Some series product can get device case temperature.
  - Support RAID 0, RAID 1, RAID 5, RAID 6 and RAID 10.
  - Support global hotspare and partial hotspare.
- User management
  - User management adopts two levels: user, user group.
  - Each user group is a set of the authorities. The authorities set is a sub set of the total authorities and editable.
  - User authorities is a sub set of its user group.
  - Reset system default user (admin) password.

- Support ONVIF user.
- Security Center
  - HTTPS login.
  - Forbid other devices logging in via IP address, MAC address.
  - Lock the specified IP address for a period of time once the login attempts has reached the threshold.
- Event Management
  - System abnormal event alarm (No HDD, storage error, IP conflict, MAC conflict, etc.)
  - AI module abnormal alarm, remote device offline alarm, etc.
  - Video detect alarm.
  - Human face detect and human face comparison alarm (The function can be realized via the smart camera or the device itself.)
  - The alarm can trigger device to record, to snapshot, to buzz or to record log file.
  - Each channel can set alarm arm/disarm time.
  - Clear alarm manually.
- System configurations
  - System language settings, user logout period settings.
  - Manually set device time, or sync time with the NTP.
  - Displayer resolution settings.
  - Create weekly task settings.
  - View system information, background running tasks.
- Real-time preview
  - Support to create views. Max support 100 views. Each view max supports 36-channel remote devices.
  - Support to create view group, it is to realize views central management.
  - Video window digital zoom function, use mouse middle button to control zoom value.
  - Display real-time bit stream, enable original scale, switch main stream/sub stream and so on on the view window
  - Smart pane display. It is to view real-time human face detection and human face comparison images.
- Record Playback
  - According to the selected type to playback record file or image
  - Search or play the record file or image in single-channel or multiple-channel mode.
  - Adopt image to display search results. At the same time, it can export record file/image to peripheral device or the PC.
  - Playback dual-bar control. Display select channel and the record process of all searched channels.
  - Use cursor, time bar, mouse-double click to fast positioning record playback time.
  - Use mouse middle button to zoom the time bar, max unit is 24 hours, min unit is 1 second. It can quickly view channel record status.
  - Multiple-record playback mode. It includes slow play, fast play, backward play, and frame by

frame playback.

- When playback record, it can display event occurred time and select any video pane to zoom in/zoom out.

■ File management

- Human face database creation. Maximum 20 databases.
- Manual upload, batch import human face images. Maximum support 100,000 images.
- Human face modeling, view current human face modeling status, human face library deployment status.

■ Intelligent analysis

- Use connected USB device or import from current human face database to use human face image to search.
- Use 10 human face images to compare according to similarity and display comparison results from the high similarity to low similarity.
- Set properties parameters to filter the comparisons results and quickly filter the information needed.
- Double click the search results to play the associated record files.

■ Operation and maintenance management

- Search system log, user operation log, event log.
- Display online user, block online user.
- Device maintenance function such as device upgrade, restore factory default settings, auto maintain.

### 1.3 Structure

It is to introduce front panel, rear panel, port function and button function, indicator light status, etc. Device supports AI module to realize human face detection, human face recognition, etc. After install the AI module, you can use the indicator lights on the rear panel to view AI module running status.

 **Note**

For some series products, AI module is optional. Please purchase separately if necessary.

#### 1.3.1 Front Panel

It is to introduce the front panel of each series product.

##### 1.3.1.1 8-HDD

The front panel is shown as in Figure 1-1.

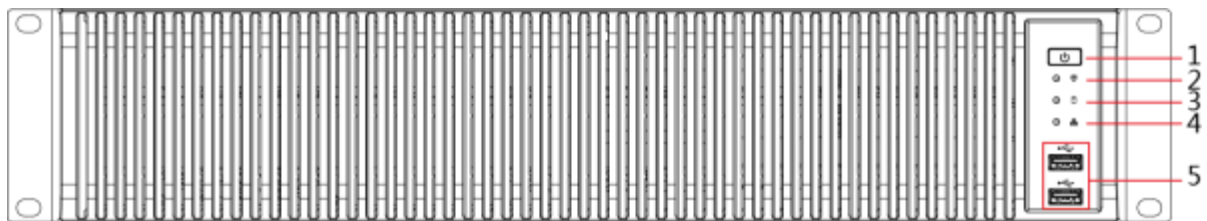

Figure 1-1

Please refer to the following sheet for detailed information.

SN	Name	Function
----	------	----------

SN	Name	Function
1	Power on-off button	<p>Boot up or shut down device. The power on-off button has the indicator light. It can display device running status.</p> <ul style="list-style-type: none"> <li>● When device is off (indicator light is off), press the button for a short period to boot up device.</li> <li>● When device is running, (blue indicator light is on), press the button for at least 4 seconds to shut down the device.</li> </ul>
2	Alarm indicator light	<p>It is to display local input alarm status.</p> <ul style="list-style-type: none"> <li>● The indicator light is off: There is no local alarm input event.</li> <li>● The blue indicator light is on: There is one or more local alarm input event.</li> </ul>
3	System status indicator light	<p>It is to display system-running status.</p> <ul style="list-style-type: none"> <li>● The blue light is on: Device is running properly.</li> <li>● The indicator light is off: The device is not running.</li> </ul>
4	Network indicator light	<p>It is to display current network status.</p> <ul style="list-style-type: none"> <li>● The indicator light is blue: It means at least one Ethernet port has connected to the network.</li> <li>● The indicator light is off: No Ethernet ports are connected to the network.</li> </ul>
5	UBS port	Connect to mouse, keyboard, USB storage device ,etc.

### 1.3.1.2 12-HDD Series

The front panel is shown as in Figure 1-2.

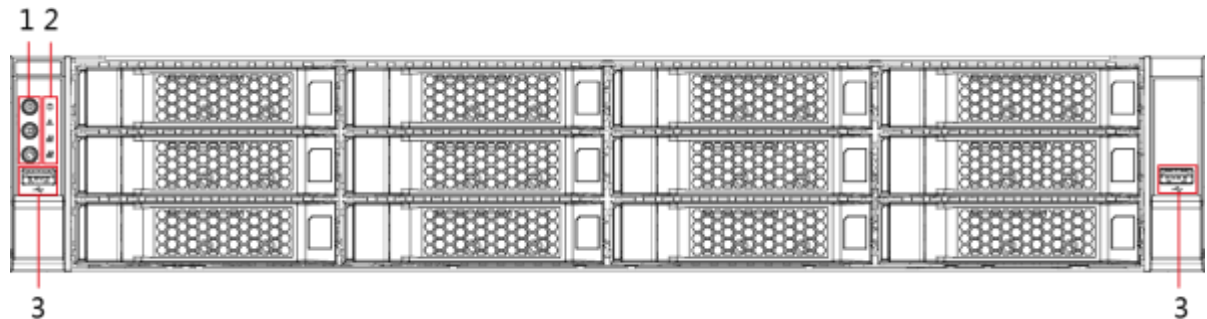

Figure 1-2

Please refer to the following sheet for detailed information.

SN	Port/Indicator Light	Note
1	Power on-off button	<p>Boot up or shut down device. The power on-off button has the indicator light. It can display device-running status.</p> <ul style="list-style-type: none"> <li>● When device is off (indicator light is off), press the button for a short period to boot up device.</li> <li>● When device is running, (blue indicator light is on), press the button for at least 4 seconds to shut down the device.</li> </ul>



SN	Port/Indicator Light	Note
	ID button	Position button. It is to control the ID indicator light on the rear panel. It is to positioning the device.  <b>Note</b> ID button has the indicator light function. Its display status is the same with the ID indicator light on the rear panel.
	RESET button	Click to restore factory default settings.
2	Power indicator light	It is to display power status. <ul style="list-style-type: none"> <li>Blue light becomes on: The device has properly connected to the power source.</li> <li>The indicator light is off: The device has not connected to the power source.</li> </ul>
	Alarm indicator light	It is to display system running status. <ul style="list-style-type: none"> <li>Green light flashes: There is no alarm.</li> <li>Red light flashes: There is an alarm (including HDD error, network error, local input alarm, etc.)</li> </ul>
	Network indicator light 1	It is to display Ethernet port 1 and Ethernet port 2 network statuses. <ul style="list-style-type: none"> <li>The indicator light is green: At least one Ethernet port has connected to the network.</li> <li>The indicator light is off: All Ethernet ports are not connected to the network.</li> </ul>
	Network indicator light 2	It is to display Ethernet port 3 and Ethernet port 4 network statuses. <ul style="list-style-type: none"> <li>The green indicator light is on: At least one Ethernet port has connected to the network.</li> <li>The indicator light is off: No Ethernet ports are connected to the network.</li> </ul>
3	USB 3.0 port	Connect to mouse, keyboard, USB storage device ,etc.

### 1.3.1.3 16-HDD Series

The front panel with LCD is shown as below. See Figure 1-3.

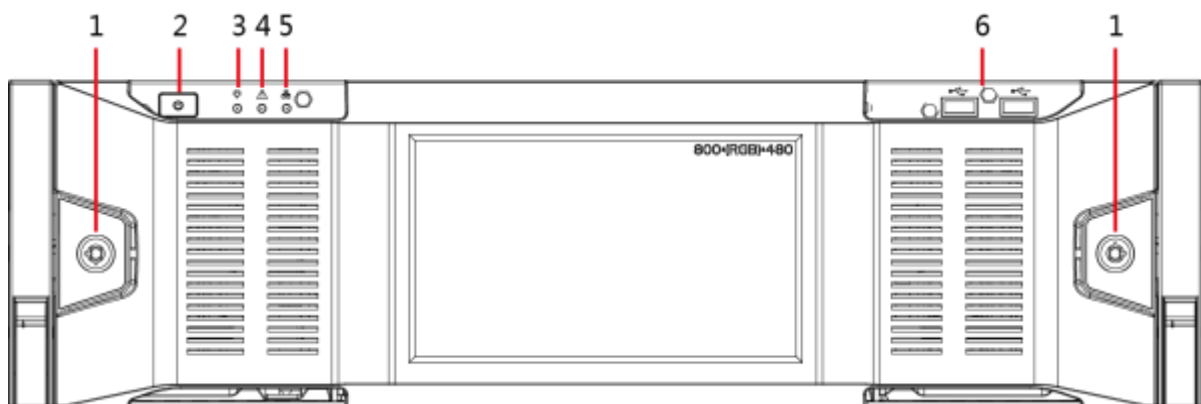

Figure 1-3

The front panel without LCD is shown as below. See Figure 1-4.

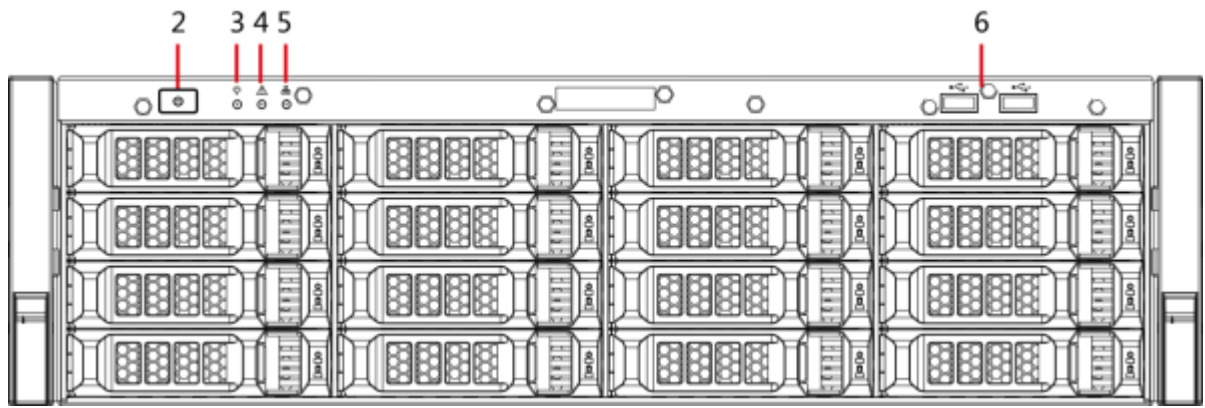



Figure 1-4

Please refer to the following sheet for detailed information.

SN	Name	Function
1	Front panel lock	Once the front panel lock is secure, it can prevent HDD stealing or remove by mistake. Unlock the front panel lock and remove the front panel, you can view 16 HDD slots. See Figure 1-4.
2	Power on-off button	<p>Boot up or shut down device. The power on-off button has the indicator light. It can display device-running status.</p> <ul style="list-style-type: none"> <li>● When device is off (indicator light is off), press the button for a short period to boot up device.</li> <li>● When device is running, (blue indicator light is on), press the button for at least 4 seconds to shut down the device.</li> </ul>
3	System status indicator light	<p>It is to display system-running status.</p> <ul style="list-style-type: none"> <li>● The blue light is on: Device is running properly.</li> <li>● The indicator light is off: The device is not running.</li> </ul>
4	Alarm indicator light	<p>It is to display local input alarm status.</p> <ul style="list-style-type: none"> <li>● The indicator light is off: There is no local alarm input event.</li> <li>● The blue indicator light is on: There is one or more local alarm input event.</li> </ul>
5	Network indicator light	<p>It is to display current network status.</p> <ul style="list-style-type: none"> <li>● The blue indicator light becomes on: At least one Ethernet port has connected to the network.</li> <li>● The indicator light is off: No Ethernet ports are connected to the network.</li> </ul>
6	USB port	Connect to mouse, keyboard, USB storage device ,etc.
7	16-HDD slot	<p>After you remove the front panel, you can see there are 16 HDDs. From the left to the right and from the top to the bottom, it ranges from 1~4, 5~8, 9~12, 13~16.</p> <p>There are two indicator lights on the HDD bracket: HDD indicator light and HDD read/write indicator light.</p> <ul style="list-style-type: none"> <li>● : HDD indicator light: The light is yellow after you install the HDD.</li> <li>● :HDD read/write indicator light: The blue light flashes when</li> </ul>

SN	Name	Function
		system is reading or writing the data.

### 1.3.1.4 24-HDD Series

The front panel with LCD is shown as below. See Figure 1-5.

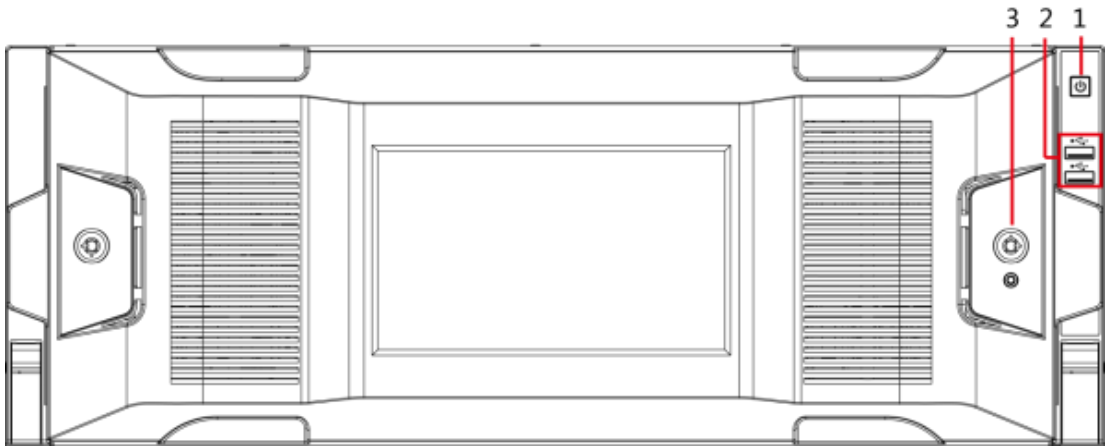

Figure 1-5

The front panel without LCD is shown as below. See Figure 1-6.

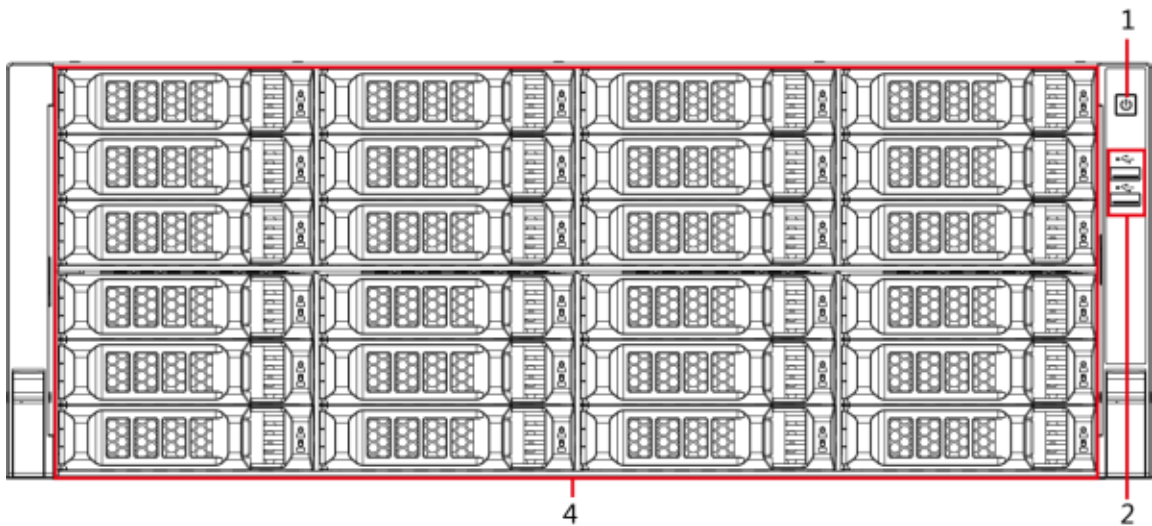

Figure 1-6

Please refer to the following sheet for front panel button information.

SN	Name	Function
1	Power on-off button	<p>Boot up or shut down device. The power on-off button has the indicator light. It can display device-running status.</p> <ul style="list-style-type: none"> <li>● When device is off (indicator light is off), press the button for a short period to boot up device.</li> <li>● When device is running, (blue indicator light is on), press the button for at least 4 seconds to shut down the device.</li> </ul>
2	USB port	Connect to mouse, keyboard, USB storage device ,etc.
3	Front panel lock	Once the front panel lock is secure, it can prevent HDD stealing or remove by mistake. Unlock the front panel lock and remove the front panel, you can view 16 HDD slots. See Figure 1-4.

SN	Name	Function
4	24-HDD slot	<p>After you remove the front panel, you can see there are 16 HDDs. From the left to the right and from the top to the bottom, it ranges from 1~4, 5~8, 9~12, 13~16, 17~20, 21~24.</p> <p>There are two indicator lights on the HDD bracket: HDD indicator light and HDD read/write indicator light.</p> <ul style="list-style-type: none"> <li>● : HDD indicator light: The light is yellow after you install the HDD.</li> <li>● : HDD read/write indicator light: The blue light flashes when system is reading or writing the data.</li> </ul>

### 1.3.2 Rear Panel

It is to introduce rear panel port function, indicator light status ,etc.

#### 1.3.2.1 8-HDD Series

The rear panel is shown as in Figure 1-7.

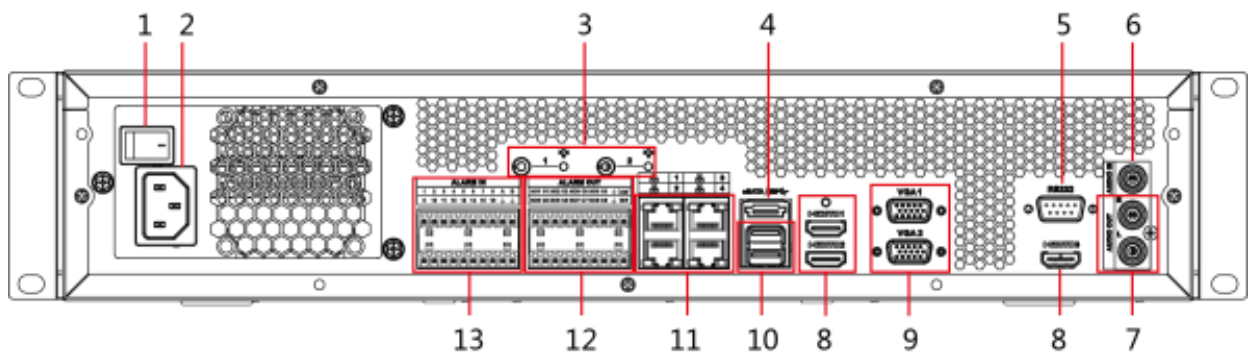



Figure 1-7

Please refer to the following sheet for detailed information.

SN	Name	Note
1	Power on-off button	Power on-off button
2	Power port	Input AC 100V-240V power
3	AI module indicator light	<p>It is to display AI module status.</p> <ul style="list-style-type: none"> <li>● The yellow light flashes, AI module is running properly.</li> <li>● The yellow light is on, AI module is malfunction.</li> </ul> <p> <b>Note</b> This function is null if there is no AI module.</p>
4	eSATA port	SATA peripheral port. Connect to SATA port.
5	RS232 port	RS232 COM debug. It is for general COM debug, set IP address, transmit transparent COM data.
6	AUDIO IN	Audio input port
7	AUDIO OUT	Audio output port

SN	Name	Note
8	High Definition Media Interface	High definition audio and video signal output port. It transmits uncompressed high definition video and multiple-channel data to the HDMI port of the display device.
9	VGA video output port	VGA video output port. Output analog video signal. It can connect to the monitor to view analog video.
10	USB port	USB port. Connect to mouse, USB storage device ,etc.
11	Network port	10M/100Mbps self-adaptive Ethernet port. Connect to the network cable.
12	Alarm output	8 groups of alarm output ports (NO1 C1~NO8 C8). Output alarm signal to the alarm device. Please make sure there is power to the external alarm device. <ul style="list-style-type: none"> <li>● NO: Normal open alarm output port.</li> <li>● C: Alarm output public end.</li> <li>● : Alarm output GND end.</li> </ul>
13	Alarm input	16 groups (1~16) alarm input ports, they are corresponding to ALARM 1~ALARM 16. The alarm becomes valid in low level. <ul style="list-style-type: none"> <li>● A/B cable: Control the A/B cable of the RS485 device. It is to connect to the PTZ camera. Please parallel connect 120Ω between A/B cables if there are too many PTZ decoders.</li> <li>● : Alarm input ground end.</li> </ul>

### 1.3.2.2 12-HDD Series

For the single-power series, the interface is shown as in Figure 1-8.

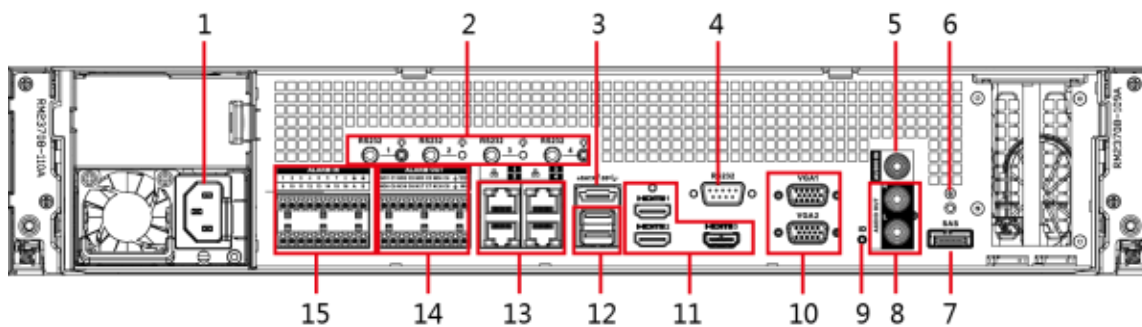

Figure 1-8

For the redundant series, the interface is shown as in Figure 1-9.

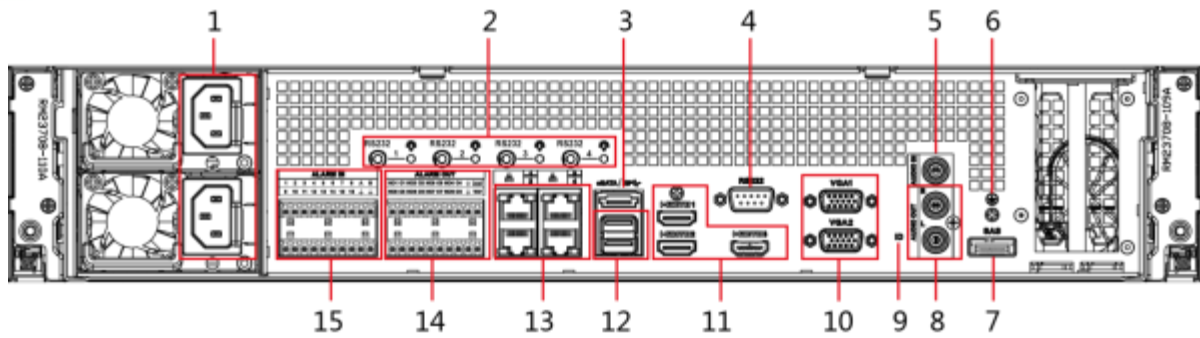



Figure 1-9

Please refer to the following sheet for rear panel button information.

SN	Name	Note
1	Power port	Input AC 100V-240V power
2	AI module indicator light	<p>It is to display AI module status.</p> <ul style="list-style-type: none"> <li>The yellow light flashes, AI module is running properly.</li> <li>The yellow light is on, AI module is malfunction.</li> </ul> <p> <b>Note</b> This function is null if there is no AI module.</p>
3	eSATA port	SATA peripheral port. Connect to device of SATA port.
4	RS232 port	RS232 COM debug. It is for general COM debug, set IP address, transmit transparent COM data.
5	AUDIO IN	Audio input port
6	GND	Ground port.
7	SAS port	SAS extension port. It can connect to the SAS extension controller.
8	AUDIO OUT	Audio output port
9	ID indicator light	<p>Positioning indicator light. It is controlled by the ID button on the front panel.</p> <ul style="list-style-type: none"> <li>Blue light is on: device is positioning now.</li> <li>Indicator light is off: device does not positioning now.</li> </ul>
10	VGA video output port	VGA video output port. Output analog video signal. It can connect to the monitor to view analog video.
11	High Definition Media Interface	High definition audio and video signal output port. It transmits uncompressed high definition video and multiple-channel data to the HDMI port of the display device.
12	USB port	USB port. Connect to mouse, USB storage device ,etc.
13	Network port	10M/100/1000Mbps self-adaptive Ethernet port. Connect to the network cable.
14	Alarm output	<p>8 groups of alarm output ports (NO1 C1~NO8 C8) . Output alarm signal to the alarm device. Please make sure there is power to the external alarm device.</p> <ul style="list-style-type: none"> <li>NO: Normal open alarm output port.</li> <li>C: Alarm output public end.</li> <li>: Alarm output GND end.</li> </ul>

SN	Name	Note
15	Alarm input	<p>16 groups (1~16) alarm input ports, they are corresponding to ALARM 1~ALARM 16. The alarm becomes valid in low level.</p> <ul style="list-style-type: none"> <li>● A/B cable: Control the A/B cable of the RS485 device. It is to connect to the PTZ camera. Please parallel connect 120Ω between A/B cables if there are too many PTZ decoders.</li> <li>● : Alarm input ground end.</li> </ul>

### 1.3.2.3 16-HDD Series

For the single-power series, the interface is shown as in Figure 1-10.

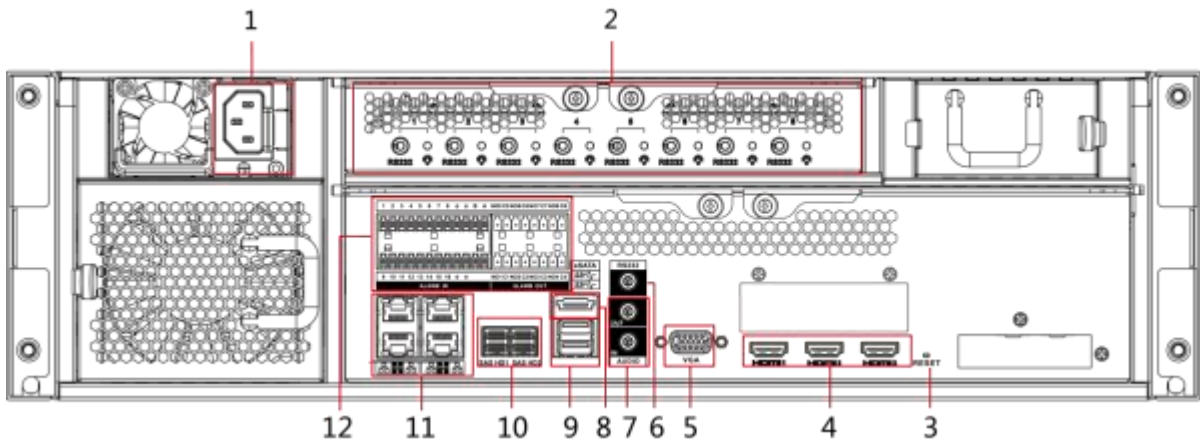

Figure 1-10

For the redundant series, the interface is shown as in Figure 1-11.

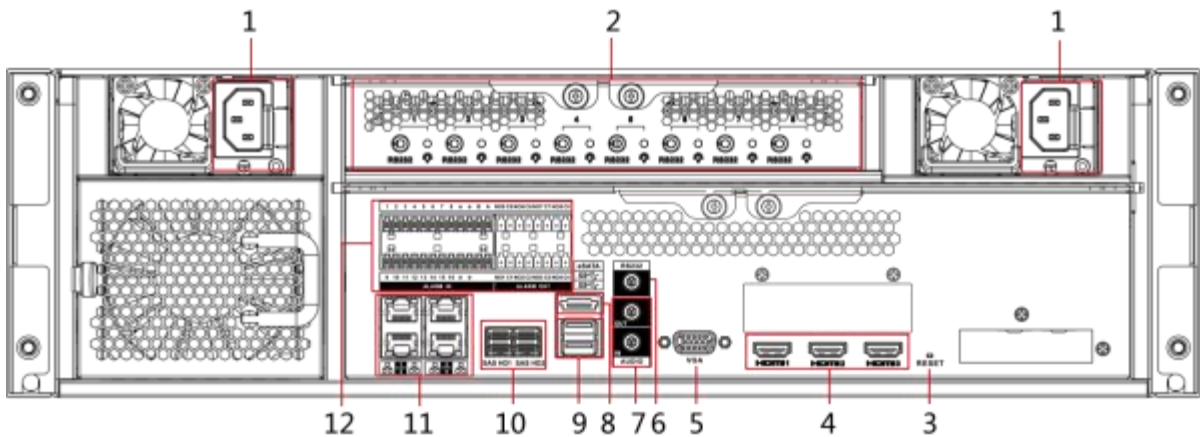





Figure 1-11

Please refer to the following sheet for rear panel button information.

SN	Name	Note
1	Power port	Input AC 100V-240V power

SN	Name	Note
2	AI module indicator light	<p>It is to display AI module status.</p> <ul style="list-style-type: none"> <li>The yellow light flashes, AI module is running properly.</li> <li>The yellow light is on, AI module is malfunction.</li> </ul> <p> <b>Note</b> This function is null if there is no AI module.</p>
3	RESET button	User needle or something like that to press the button, device restores factory default settings.
4	High Definition Media Interface	High definition audio and video signal output port. It transmits uncompressed high definition video and multiple-channel data to the HDMI port of the display device.
5	VGA video output port	VGA video output port. Output analog video signal. It can connect to the monitor to view analog video.
6	AUDIO IN	Audio input port
	AUDIO OUT	Audio output port
7	RS232 port	RS232 COM debug. It is for general COM debug, set IP address, transmit transparent COM data.
8	eSATA port	SATA peripheral port. Connect to device of SATA port.
9	USB port	USB port. Connect to mouse, USB storage device ,etc.
10	SAS port	SAS extension port. It can connect to the SAS extension controller.
11	Network port	10M/100/1000Mbps self-adaptive Ethernet port. Connect to the network cable.
12	Alarm input	<p>16 groups (1~16) alarm output ports, they are corresponding to ALARM 1~ALARM 16. The alarm becomes valid in low level.</p> <ul style="list-style-type: none"> <li>A/B cable: Control the A/B cable of the RS485 device. It is to connect to the PTZ camera. Please parallel connect 120Ω between A/B cables if there are too many PTZ decoders.</li> <li>: Alarm input ground end.</li> </ul>
	Alarm output	<p>8 groups of alarm input ports (NO1 C1~NO8 C8) . Output alarm signal to the alarm device. Please make sure there is power to the external alarm device.</p> <ul style="list-style-type: none"> <li>NO: Normal open alarm output port.</li> <li>C: Alarm output public end.</li> <li>: Alarm output GND end.</li> </ul>

#### 1.3.2.4 24-HDD Series

For the single-power series, the interface is shown as in Figure 1-12.



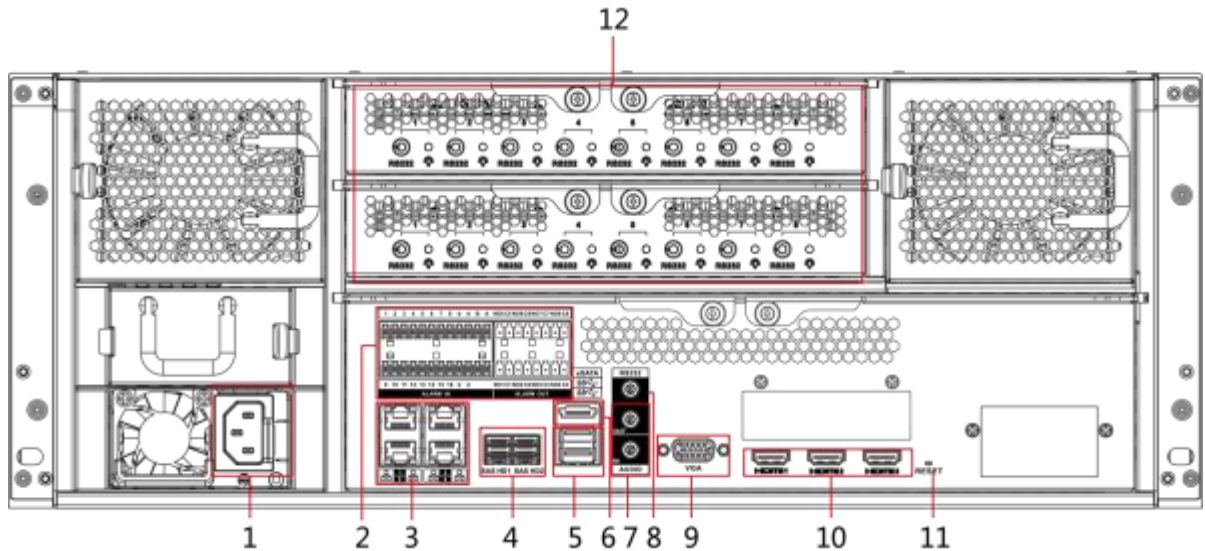

Figure 1-12

For the redundant series, the interface is shown as in Figure 1-13.

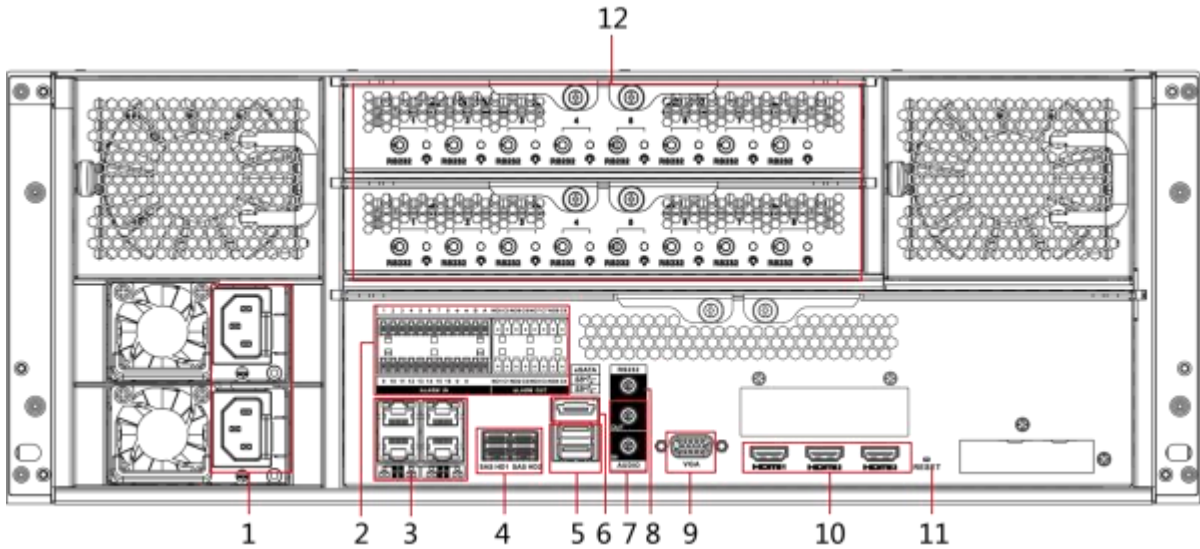



Figure 1-13

Please refer to the following sheet for rear panel button information.

SN	Name	Note
1	Power port	Input AC 100V-240V power
2	Alarm input	<p>16 groups (1~16) alarm output ports, they are corresponding to ALARM 1~ALARM 16. The alarm becomes valid in low level.</p> <ul style="list-style-type: none"> <li>● A/B cable: Control the A/B cable of the RS485 device. It is to connect to the PTZ camera. Please parallel connect 120Ω between A/B cables if there are too many PTZ decoders.</li> <li>● : Alarm input ground end.</li> </ul>

SN	Name	Note
	Alarm output	<p>8 groups of alarm output ports (NO1 C1~NO8 C8) . Output alarm signal to the alarm device. Please make sure there is power to the external alarm device.</p> <ul style="list-style-type: none"> <li>● NO: Normal open alarm output port.</li> <li>● C: Alarm output public end.</li> <li>● : Alarm output GND end.</li> </ul>
3	Network port	10M/100/1000Mbps self-adaptive Ethernet port. Connect to the network cable.
4	SAS port	SAS extension port. It can connect to the SAS extension controller.
5	USB port	USB port. Connect to mouse, USB storage device ,etc.
6	eSATA port	SATA peripheral port. Connect to device of SATA port.
7	AUDIO IN	Audio input port
	AUDIO OUT	Audio output port
8	RS232 port	RS232 COM debug. It is for general COM debug, set IP address, transmit transparent COM data.
9	VGA video output port	VGA video output port. Output analog video signal. It can connect to the monitor to view analog video.
10	High Definition Media Interface	High definition audio and video signal output port. It transmits uncompressed high definition video and multiple-channel data to the HDMI port of the display device.
11	RESET button	User needle or something like that to press the button, device restores factory default settings.
12	AI module indicator light	<p>It is to display AI module status.</p> <ul style="list-style-type: none"> <li>● The yellow light flashes, AI module is running properly.</li> <li>● The yellow light is on, AI module is malfunction.</li> </ul> <p> <b>Note</b></p> <p>This function is null if there is no AI module.</p>

## 2 Installation and Connection

This chapter is to introduce HDD installation, cable connection, etc.



### Warning

Some series product is heavy. It needs several persons to carry or move in case there is person injury.

### 2.1 Installation Flows

Refer to Figure 2-1 for installation flows. Please follow the steps to install.

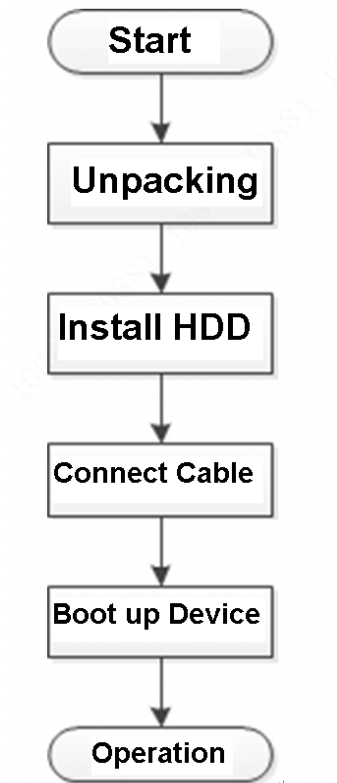

Figure 2-1

### 2.2 Unpacking

After you received the device from the forwarder, please open the box and then check with the following sheet. If there is any problem, contact your local retailer or service engineer for help.

SN	Name	Contents	
1	Whole package	Appearance	There is any visible damage or not.
		Package	There is any accidental clash during transportation or not.
2	Front panel and rear	Appearance	There is any visible damage or not.
		Device model	The model is right or not.

SN	Name	Contents
	panel	<p>The label on the device</p> <p>It is neat and clean or not.</p> <p> <b>Note</b></p> <p>Do not tear off, or discard the label. Usually we need you to represent the serial number when we provide the service after sales.</p>

## 2.3 HDD Installation

This chapter is to introduce HDD installation information.

**Note**

Different series products support different HDD amount. Refer to the actual product for detailed information.

### 2.3.1 12-HDD Series



**CAUTION**

Do not close the handle if you have not pushed the HDD box to the end. Otherwise, it may result in HDD slot damage.

### Install HDD

<p><b>Button</b></p>		
<p>① Press the button on the HDD box at the front panel, open the handle and pull out to take the empty HDD box.</p>	<p>② Follow the higher side of the installation surface to install the HDD and then push down. It is to install the HDD to the other side of the installation surface.</p>	<p>③ Insert the HDD box to the HDD slot of the device, and then push to the end to close then HDD box handle.</p>

### Remove HDD

<p>① Press the button on the HDD box at the front panel, open the handle and pull out to take the empty HDD box.</p>	<p>② On the back side of the HDD box, refer to icon marked on the above figure to push hard.</p>	<p>③ Take the HDD out. Insert the HDD box back to the HDD slot, push to the end and then close the HDD box handle</p>

### 2.3.2 16/24-HDD Series



CAUTION

Do not close the handle if you have not pushed the HDD box to the end. Otherwise, it may result in HDD slot damage.

### Install HDD

<p>① Press the red button on the HDD box at the front panel, open the handle.</p>	<p>② Pull out to take the empty HDD box and then Install the HDD to the HDD box</p>	<p>③ Secure the screws at the bottom of the box, insert the HDD box to the HDD box slot and then push to the end, and then close the HDD box handle.</p>

### Remove HDD

- Step 1 Press the red button on the HDD box at the front panel, open the handle.
- Step 2 Pull out to take the HDD box.
- Step 3 Unfasten the screws on the rear panel of the HDD box, and then take out the HDD.
- Step 4 Insert the HDD box back to the HDD slot, push to the end and then close the HDD box handle.

## 2.4 Cable Connection

Refer to Figure 2-2 for device cable connection information.

- Connect displayer, mouse, and keyboard and so on for local menu operation.
- Install AI module first if you want to use intelligent functions such as human face detection, human face recognition function.



**CAUTION**

**DO NOT CHANGE OR REPLACE THE AI MODULE WHEN DEVICE IS RUNNING.** Shut down the device first and then remove the AI module, otherwise, the data on the AI module may result in damage.

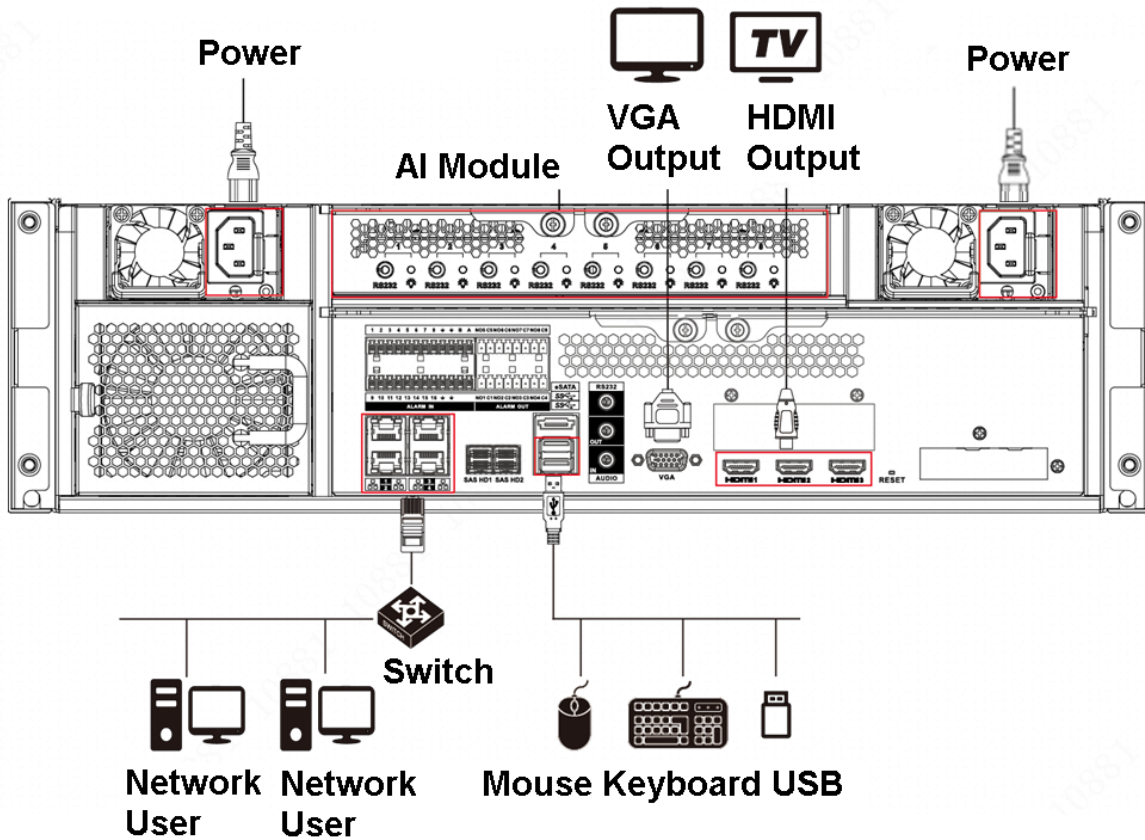

Figure 2-2

### 3 Before the Start

It is to introduce some necessary information such as how to use mouse, input method, some menu items.

#### 3.1 Mouse Operation

Connect mouse to the USB port, you can use the mouse to control the local menu.

Operation	Function
Left click mouse	<ul style="list-style-type: none"> <li>• Left click mouse to select a function menu, it is to enter the corresponding menu interface.</li> <li>• Follow the operation on the controls.</li> <li>• Change check box, option button status.</li> <li>• Left click check box to display dropdown list.</li> <li>• On virtual keyboard, it is to select letter, symbol, English upper letter and lower letter, Chinese letters.</li> </ul>
Double click left button	<ul style="list-style-type: none"> <li>• On Preview interface, double click one video window to zoom in the window, click any position out of the window, the video window restores original size.</li> <li>• On Preview interface, double click the remote device on the device tree, it is to switch to video edit status. It is to add remote device.</li> <li>• Double click the image or record file thumbnail, it is to playback record file or view the image.</li> </ul>
Right click mouse	<ul style="list-style-type: none"> <li>• On Preview or Search interface, right click one video window to display right-click menu.</li> <li>• On Preview interface, right click the View on the list or the remote device on the device tree, it is to display right-click menu.</li> </ul>
Rolling the middle button	<ul style="list-style-type: none"> <li>• On Search interface, move the cursor to the time bar and then click the mouse middle button, it is to adjust the accurate time on the time bar.</li> <li>• Click the control that needs to input number (such as input date or time), roll the middle button to adjust the number value.</li> </ul>
Drag the mouse	<ul style="list-style-type: none"> <li>• Drag the mouse to select the motion detect zone.</li> <li>• On Preview interface, drag the remote device on the device tree to the play window, switch to the view status. It is to add the remote device.</li> <li>• On Search interface, drag the record file or the image thumbnail to the playback window, it is to playback the corresponding record file or image.</li> </ul>

#### 3.2 Virtual Keyboard

On device local menu, it supports virtual keyboard function.

 **Note**

If the device has connected to the peripheral keyboard, click the text column, there is no virtual keyboard. Click the text column, system displays virtual keyboard interface. See Figure 3-1(Full display) or Figure 3-2(digital keyboard).

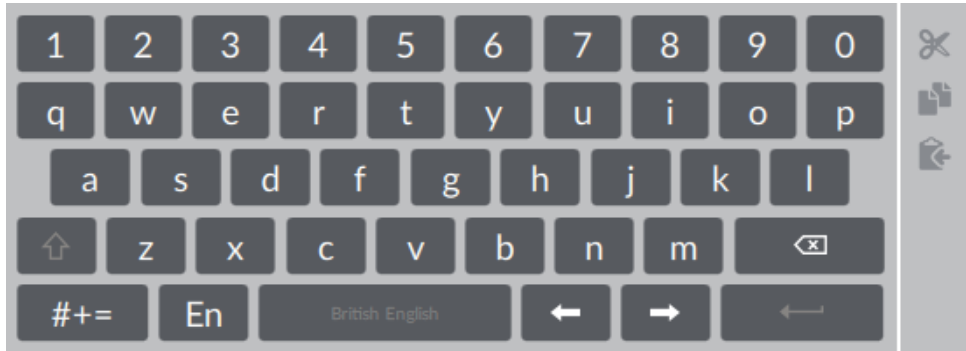

Figure 3-1



Figure 3-2

Icon	Function
	Click the icon to switch between upper case and lowercase.  is the upper case.
	Click to delete letter.
	Click to input letter. See Figure 3-3. Now the icon becomes . Click  to restore previous input mode.
	Click to input space.
	Click to control cursor position.
	Click to switch to the next line.
	Select letters and click the icon to cut the selected contents.
	Select letters and click the icon to copy the selected contents.
	After select to cut or copy the contents, click the text box and click the icon to paste the contents.





Figure 3-3

### 3.3 Menu Item

Icon/Button	Function
	Add icon. Click the icon, system can display the hidden applications interface. You can view or open the applications.
	Help information. Move the cursor to the icon, device can display help information.
	Display or hide icon. Click the icon to display the hidden menu. Now the icon is shown as  /  / . Click  /  /  again to hide the menu items.
<input type="checkbox"/>	Check the box, you can select multiple menu items at the same time. <input checked="" type="checkbox"/> means checked.
<input type="radio"/>	Check box, select one menu item, <input checked="" type="radio"/> means checked.
	Dropdown box, click the box to view the dropdown menu.
	Enable icon. <ul style="list-style-type: none"> <li>: Disabled function.</li> <li>: Enabled function</li> <li>:Invalid function. It is only valid in some special criteria.</li> <li>: The functions cannot be disabled.</li> </ul>
<input type="text" value=""/>	Search column. Input key words, click  to search the corresponding information.
<input type="text" value=""/>	Text column. Input number, letter, symbol ,etc.

Icon/Button	Function
Refresh	Refresh button, click it to view the latest configuration information.
Cancel	Cancel button, click it to cancel the configuration items and then return to the upper-level menu.
✕	Close button, click the icon to close the window.

## 4 Start-Up

If it is your first time to boot up the device, please initialize the device, set basic information and functions, etc.

### 4.1 Boot up



#### Warning

Before the boot up, please make sure:

- The rated input voltage shall match the device power on-off button. Please make sure the power wire connection is OK.
- For device security, please connect the device to the power adapter first and then connect the device to the power socket.
- The rated input voltage matches the device power on-off button. Please make sure the power wire connection is OK. Then click the power on-off button.
- Always use the stable current, if necessary UPS is a best alternative measure.
- Some series products do not have power on-off button, connect the device to the power socket to boot up directly.

Before you boot up device, please refer to chapter 2.4 Cable connection to connect cable.

- For 8-HDD series product: Press the power button on the rear panel to boot up device.
- For other series products:
  - ◇ Connect to the power socket to boot up device.
  - ◇ After click shutdown button on the GUI to turn off the device, press the power button for a short period of time to boot up device.

### 4.2 Device Initialization

If it is your first time to use the device, please set a login password of **admin** (system default user). At the same time, you can set proper password protection method.

#### Steps

Step 1 Boot up device.

Enter device initialization interface. See Figure 4-1.

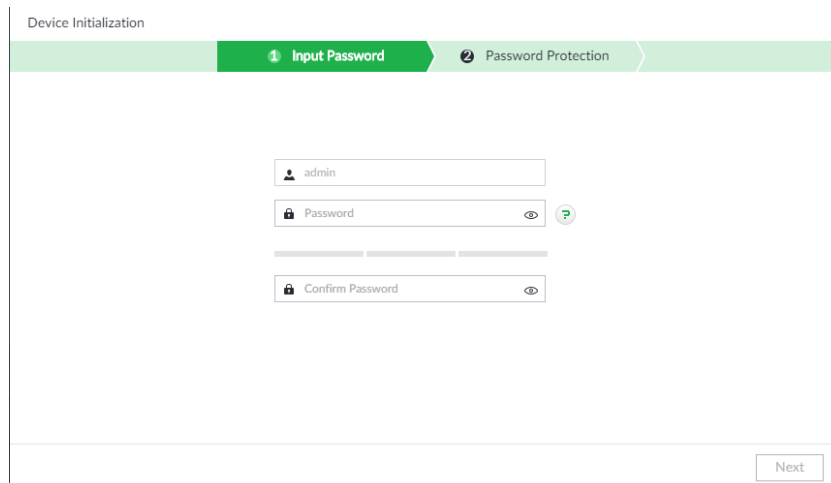

Figure 4-1

Step 2 Set **admin** login password.

Name	Function
User	The default user name is <b>admin</b> .
Password	The password ranges from 8 to 32 digitals. It can contain letters, numbers and special characters (excluding “” , “” , “,” , “:” , “&” ) . The password shall contain at least two categories. Usually we recommend the strong password.
Confirm password	<p> <b>Note</b></p> <p>After input password, use mouse to press  to display password. Release the mouse or move mouse to other position, the password is displayed at hidden mode again.</p>
Prompt question	<p>After you set proper question, move the mouse to the  on the login interface, system displays corresponding password prompt question. It is to help you remember password.</p> <p> <b>Note</b></p> <p>The prompt question function is for local login interface only. Refer to the actual interface for detailed informaiton.</p>

Step 3 Click Next.

Enter password protection interface. See Figure 4-2.

Figure 4-2

Step 4 Set password protection information.

Setting the security questions here, you can use the email you input here or answer the security questions to reset **admin** password. Refer to chapter 6.6.2.4 Reset password for detailed information.

**Note**

Click to cancel the email or security questions box.

Password protection	Note

Password protection	Note
Email	Input an email address for reset password purpose. In case you forgot password in the future, input the security code you got on the assigned email to reset the password of <b>admin</b> . Go to the main menu->Setting->System->Account to set. Refer to chapter 6.6.2.2 Edit user for detailed information.
Security question	Set security questions and corresponding answers. Properly answer the questions to reset <b>admin</b> password.

Step 5 Click Finish to complete device initialization.  
System displays device initialization successful interface. See Figure 4-3. Click Enter quick settings button to go to the quick setting interface. It is to set device basic information. Refer to chapter 4.3 Quick settings for detailed information.

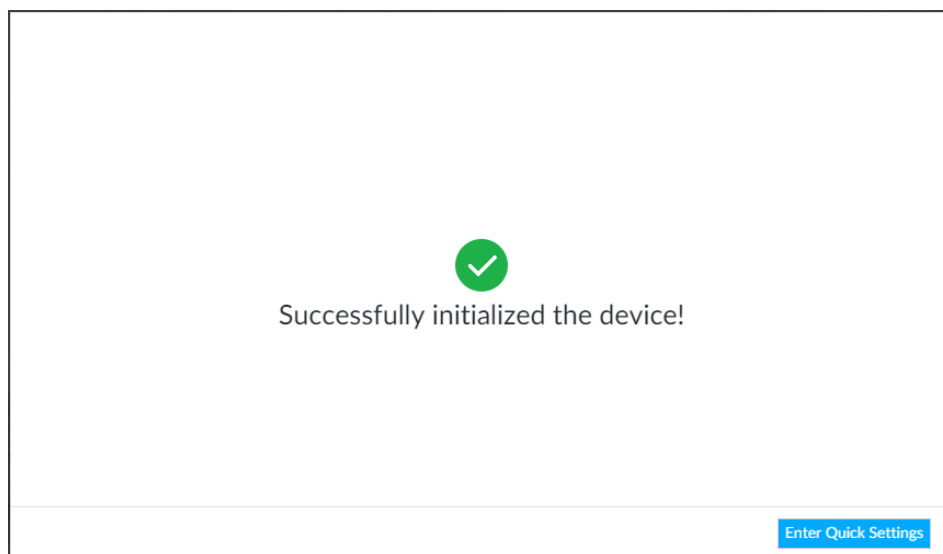

Figure 4-3

## 4.3 Quick Settings

After initialize the device, it goes to quick settings interface. You can quickly set system time, IP address and P2P.

### 4.3.1 System Time

It is to set system time. Please enable/disable NTP function according to your actual requirements. After enable NTP function, device can automatically synchronize time with the NTP server.

#### Steps

Step 1 On initialization interface, click Enter quick settings button.  
Enter time setting interface. See Figure 4-4.

1 Time
2 IP Set
3 P2P Access



Date  
2018.01.22

Time  
15:36:34

---

Time  Manual Setting

Date/Time

Sync with Internet Time Server

Server

Auto Sync Time Interval

Time and Date Format

Time Zone

Figure 4-4

Step 2 Set parameters.

Name	Function
Time	<p>It is to set system date and time. You can set manually or set device to synchronize time with the NTP server.</p> <ul style="list-style-type: none"> <li>Manual setting: Select manual setting and then input actual date and time.</li> <li>Sync with the Internet Time Server: Check the box and then input NTP server IP address or domain, and then set the synchronization interval.</li> </ul>
Time and date format	Set system date and time display format.
Time zone	Set device time zone.

Step 3 Click Next to save settings.

### 4.3.2 IP Address

It is to change device IP address, DNS server information and so on according to the actual situation.



**Note**

Device has 4 Ethernet ports by default. Make sure at least one Ethernet port has connected to the network before you set IP address.

### Steps

- Step 1 On Time setting interface, click Next button.  
Enter IP setting interface. See Figure 4-5.

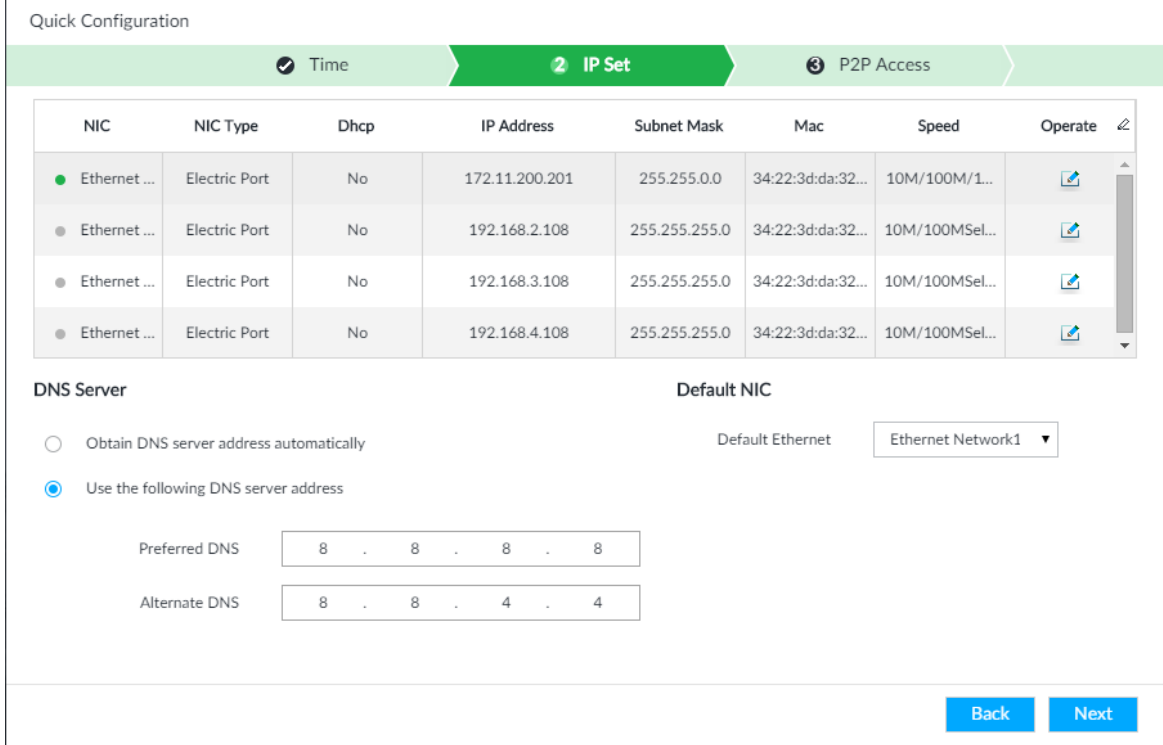



Figure 4-5

Step 2 Set IP address.

1. Click the  of the corresponding Ethernet port.

Enter Edit Ethernet setting interface. See Figure 4-6.

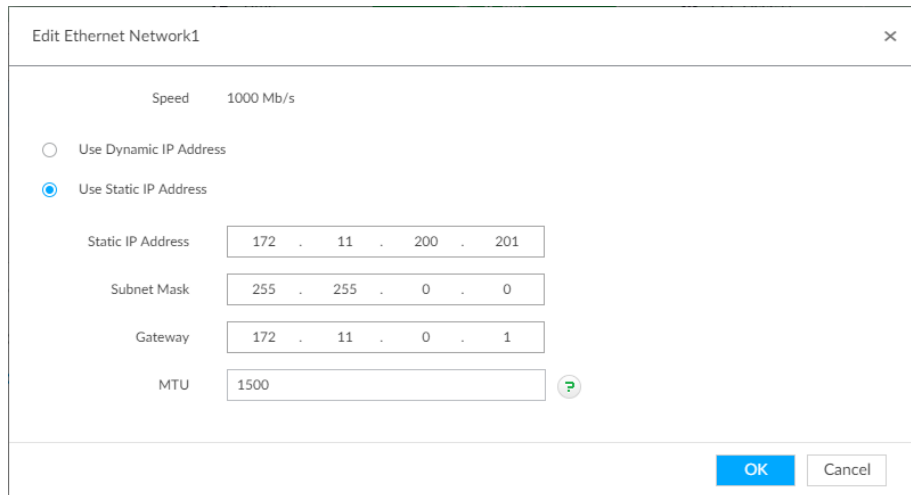



Figure 4-6

2. Set parameters.

Name	Function
Speed	Current NIC max network transmission speed.
Use dynamic IP address	When there is a DHCP server on the network, check the box to use dynamic IP address, system can allocate an dynamic IP address to the device. There is no need to set IP address manually.
Use static IP address	Check the box to use static IP address. Please set static IP address, subnet mask and gateway. It is to set a static IP address for the device.

Name	Function
MTU	<p>Set NIC MTU value. The default setup is 1500 Byte.</p> <p>We recommend you to check the MTU value of the gateway first and then set the device MTU value equal to or smaller than the gateway value. It is to reduce the packets slightly and enhance network transmission efficiency.</p> <p> <b>Caution</b></p> <p>Changing MTU value may result in NIC reboot, network offline and it may affect current running operation. Please be careful!</p>

3. Click OK.

Device goes back to IP setting interface.

Step 3 Set DNS server information.

You can select to automatically to get DNS address or input DNS server address manually.

 **Note**

Follow the steps listed below if you want to use domain service.

- Auto get DNS server address: Check the box to auto get DNS server address, device can automatically get the DNS server IP address on the network.
- Use the following DNS server address: Check the box to use the following DNS server addresses, and then input primary DNS and alternate DNS IP address.

Step 4 Set default NIC.

Select default Ethernet card from the dropdown list.

 **Note**

Make sure the network card has connected to the network.

Step 5 Click OK.

### 4.3.3 P2P

P2P is a peer to peer technology. You can scan the QR code to download cellphone APP without DDNS service or the port mapping or installing the transmission server. After register the device to the APP, you can view the remote video, playback record file etc.

 **Note**

Make sure the system has connected to the network. Otherwise, the P2P function is null.

### Steps

Step 1 On IP setting interface, click Next.

Enter P2P interface. See Figure 4-7.



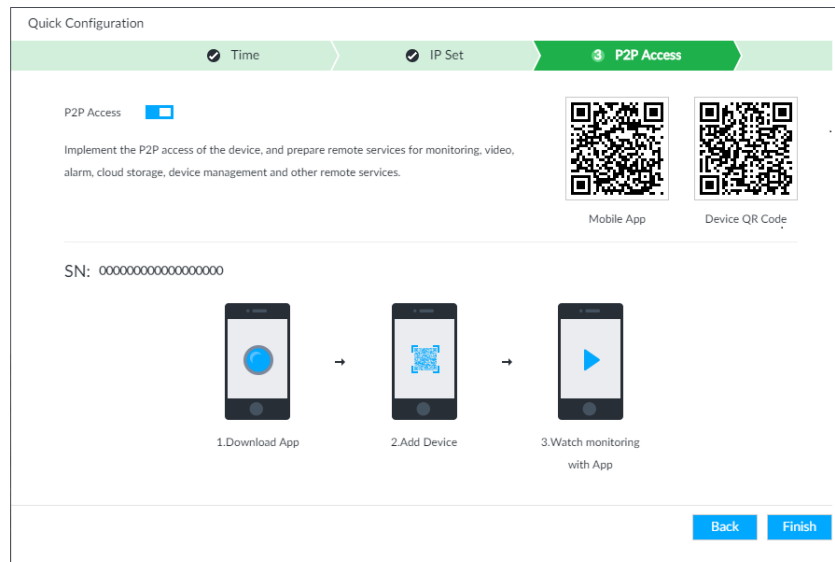

Figure 4-7

Step 2 Click  to enable P2P function. The function is disabled by default.

Step 3 Click Finish to save settings.

After the configuration, you can register a device to the APP to view remote video, playback record file ,etc. Refer to corresponding cellphone APP for detailed information.

## 4.4 Register Remote Device

After you register the remote device to the system, you can view the real-time video from the remote device, change remote device settings, etc.

Device supports two add modes: short-cut add, and manual add.



### Caution

Uninitialized remote device cannot register to the system. Refer to chapter 6.2.2.2 Initialize remote device for detailed information.

### 4.4.1 Short-Cut Menu

It is to search the remote devices on the same network and then filter to register. It is useful if you do not know the exact IP address.

### Steps

Step 1 Click .

Enter Setting interface. See Figure 4-8.

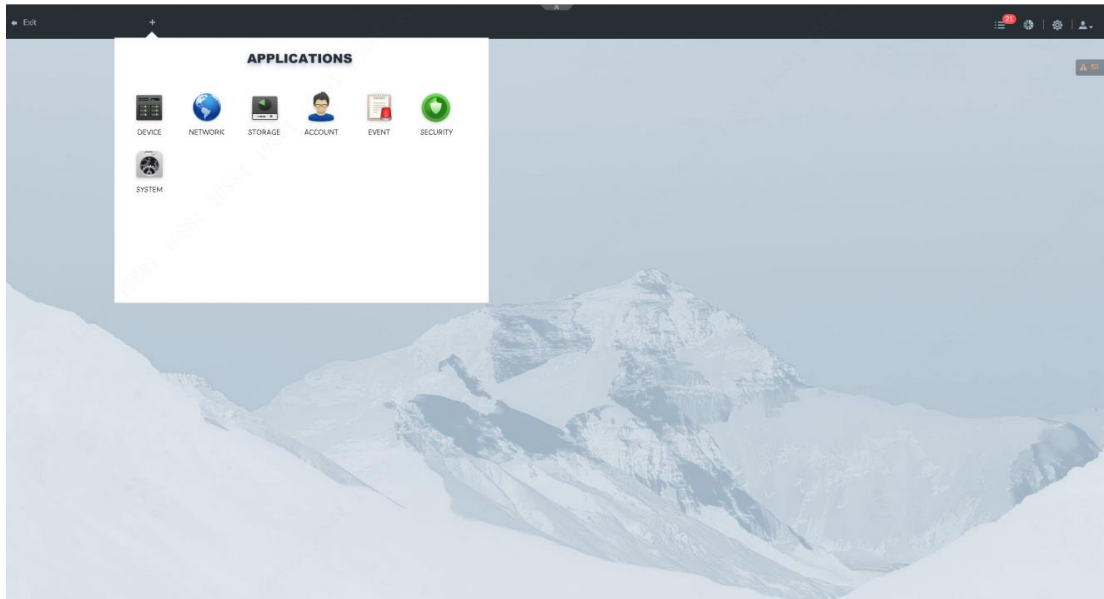

Figure 4-8

- Step 2 Select Device.  
Enter device manager interface. See Figure 4-9.

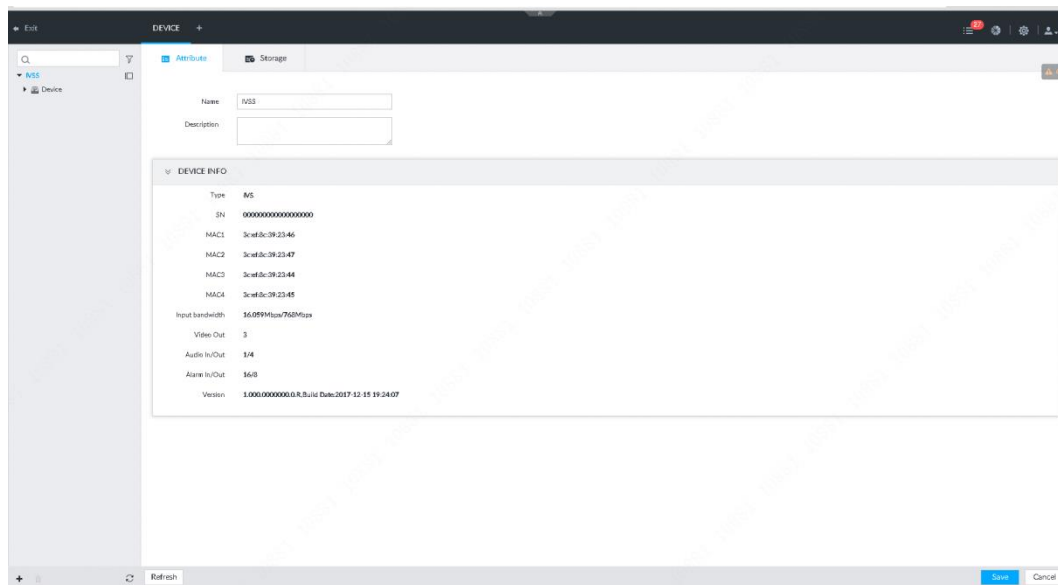



Figure 4-9

- Step 3 Click  at the bottom left corner and then select Smart add.  
Enter add device interface. See Figure 4-10.

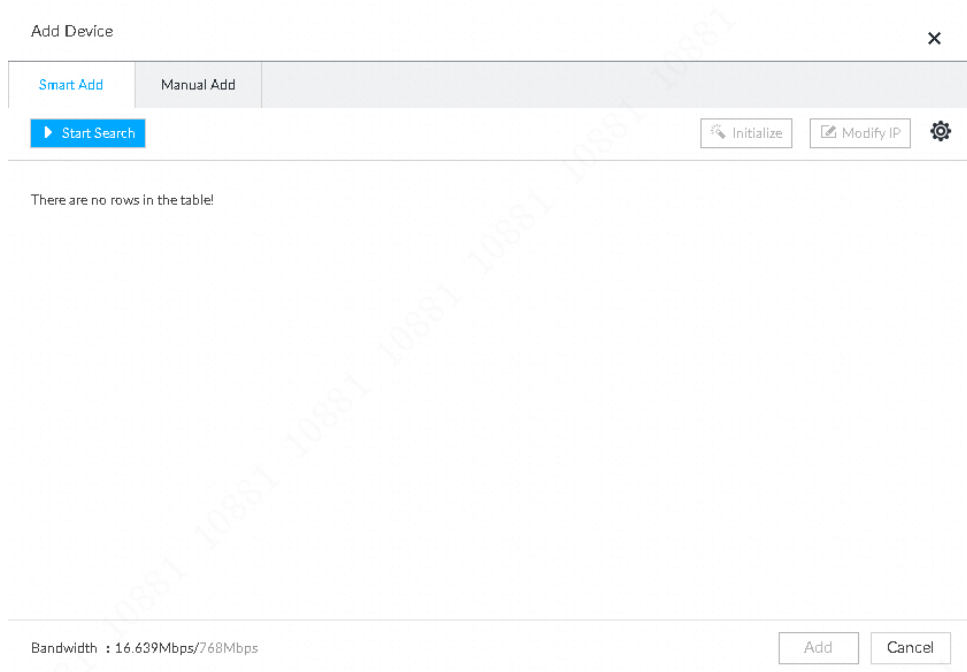

Figure 4-10

Step 4 Search remote device.

**Note**

Device searches the remote devices on the device same IP segment by default if there is no search criteria.

1. Click .

Enter Add interface. See Figure 4-11.

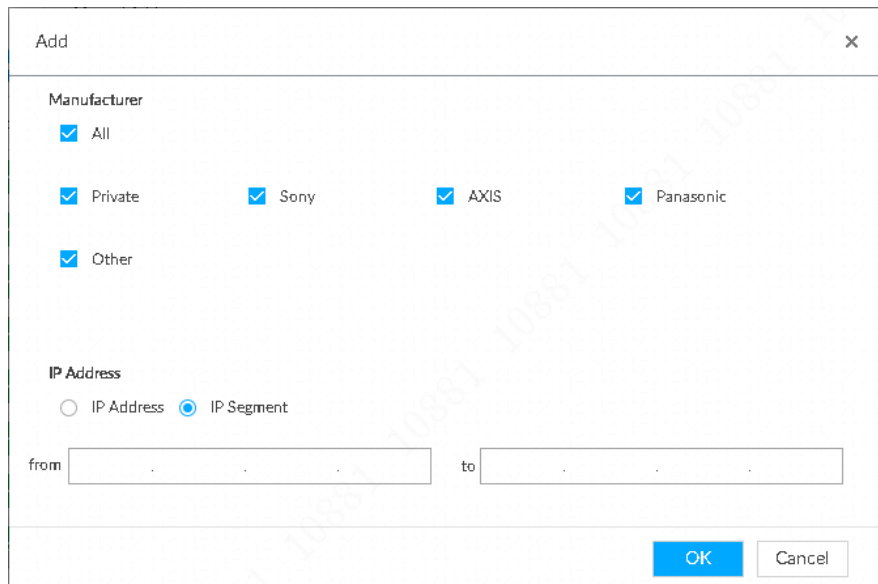

Figure 4-11

2. Select manufacturer name, and then set IP address you want to search.

- IP address: Set remote device IP address. Device only searches the remote device of the specified IP address.

- IP segment: Set remote device IP segment. Device searches the remote devices of the specified IP segment.
3. Click OK to save settings.  
Device goes back to device manager interface.
  4. Click Start search.  
Device begins search remote devices and display search result. See Figure 4-12.

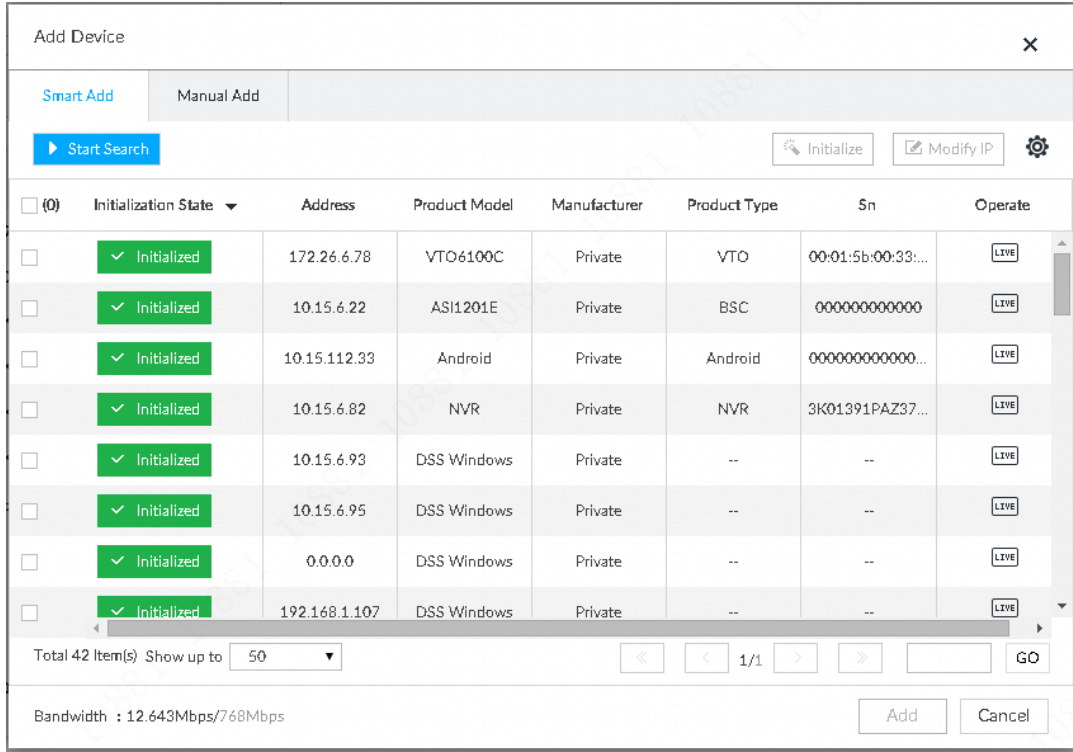

Figure 4-12

Name	Function
Start search	Click to start searching remote device. Now it becomes Stop search button. Click Stop search button to stop searching remote device.
Initialize	Select uninitialized remote device and then click Initialize button to initialize remote device. Refer to chapter 6.2.2.2 Initializing remote device for detailed information.
Modify IP	Select remote device and then click Modify IP, it is to change remote device IP address. Refer to chapter 6.2.2.3 Changing remote device IP address for detailed information.
Initialization State	It is to display remote device initialization status. Click ▼ to filter initialized or uninitialized remote device.
Address	It is to display remote device IP address, product type, manufacturer, product type and SN.
Product Model	
Manufacturer	
Product type	
SN	

Name	Function
Operation	<p>Click <input type="button" value="LIVE"/> to display real-time preview video from the remote device. See Figure 4-13. Click <input type="button" value="X"/> or Close to close the real-time preview window.</p> <p> <b>Note</b> You can click the <input type="button" value="LIVE"/> to view the real-time video if the remote device admin password is <b>admin</b>, or remote device admin's password is the same as the system.</p>
Show up to	<p>It is to set the remote device amount in the list.</p> <ul style="list-style-type: none"> <li><input type="button" value="&lt;"/> / <input type="button" value="&gt;"/>, switch PgUp/PgDw.</li> <li><input type="button" value="&lt;&lt;"/> / <input type="button" value="&gt;&gt;"/>, Go to the first page or the last page.</li> <li>Input page number in the <input type="text"/>, Click Go to go to the specified page.</li> </ul>
Bandwidth	It is to display registered remote device bandwidth and supported remote device bandwidth.

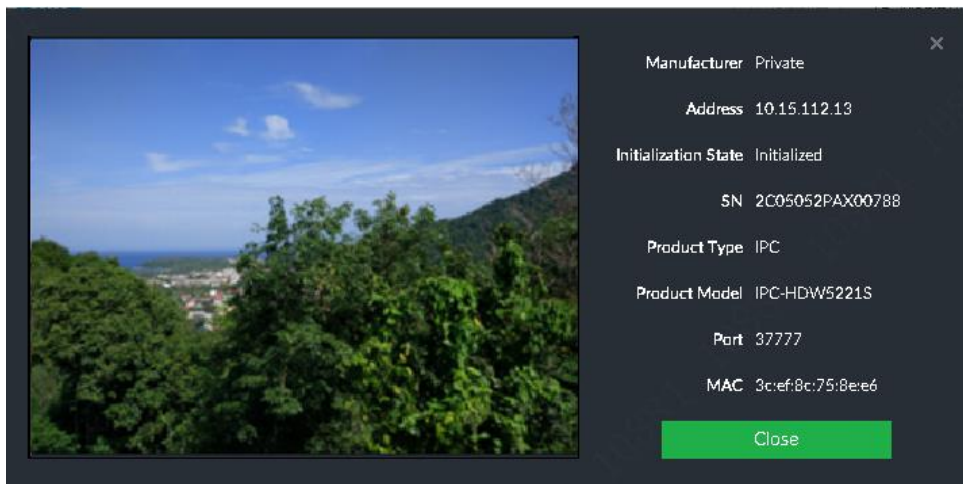

Figure 4-13

Step 5 Add remote device.

- Add 1-channel remote device.

Select a remote device and then click Add bottom. Device begins adding remote device and pops up confirmation interface. See Figure 4-14.

**Note**

During the adding process, click Cancel button, you can cancel adding process. Click the stop button of the corresponding remote device to cancel add.

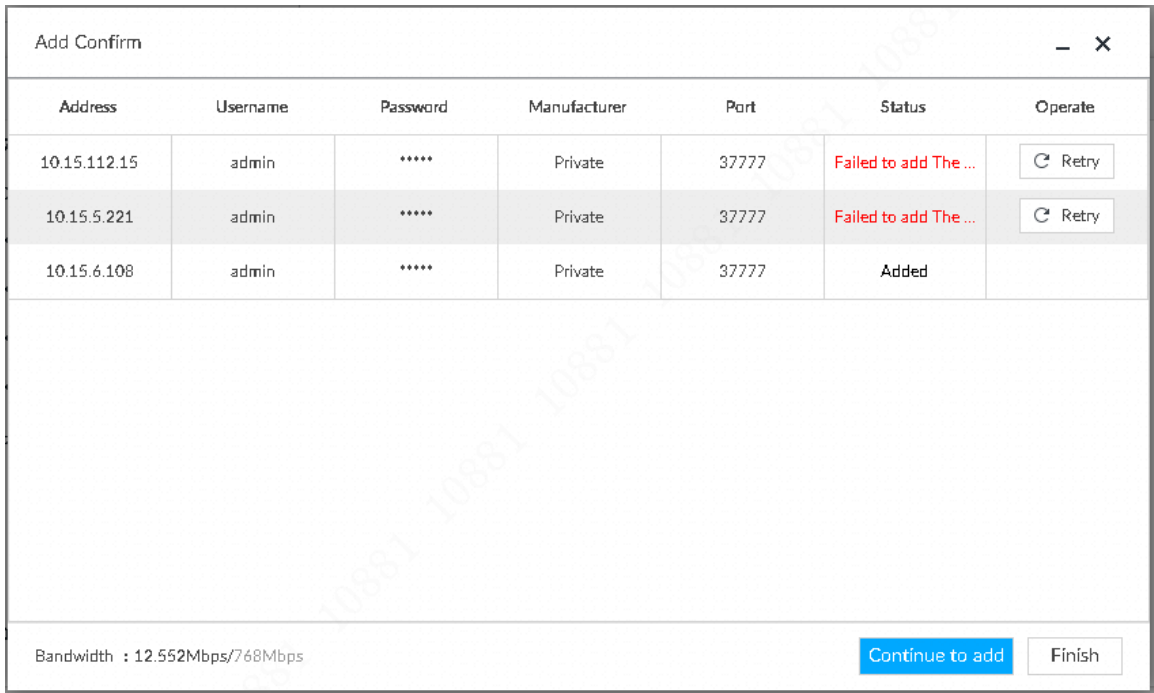

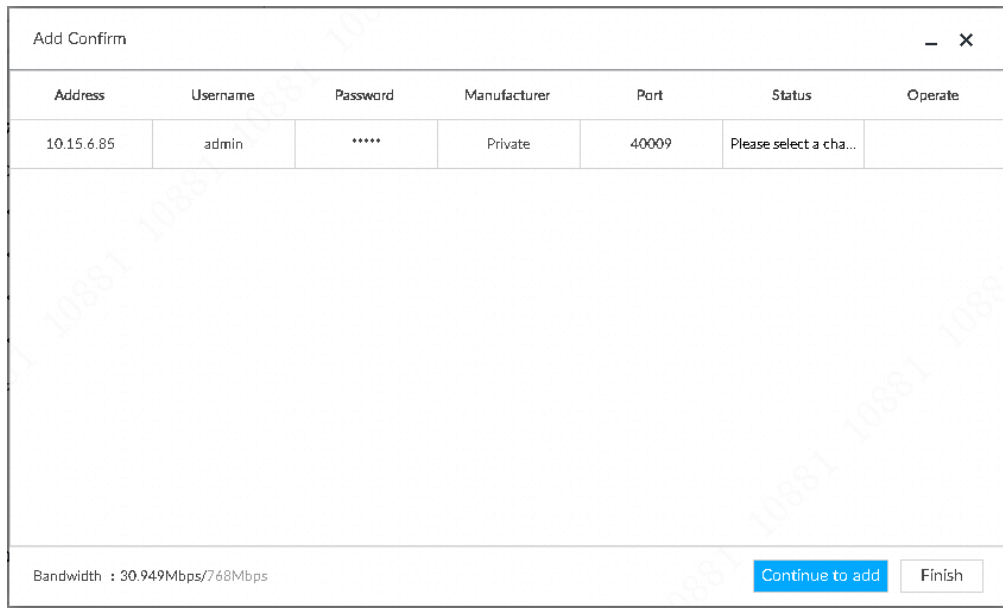

Figure 4-14

Name	Function
Address	It is to display remote device IP address.
User name	It is to display remote device user name and password.
Password	System default user name is <b>admin</b> and password is <b>admin</b> . The register operation may fail if the system user name or password is not the same with the remote device.
Manufacturer	It is to display manufacturer information.
Port	It is to display remote device port number.
Status	It is to display system and remote device connection status.
Operation	<p>If system fails to add the remote device, refer to the reason on the Status column to change the remote device information and then click Retry to try to add again.</p> <p> <b>Note</b>            Double click remote device IP address, user name, password, manufacturer, port to change corresponding information.</p>

- Add multiple-channel remote device
  1. Select a remote device and then click Add button.  
Enter add confirmation interface. See Figure 4-15.



Address	Username	Password	Manufacturer	Port	Status	Operate
10.15.6.85	admin	****	Private	40009	Please select a cha...	

Bandwidth : 30.949Mbps/768Mbps

Continue to add Finish

Figure 4-15

2. Double click select a channel.  
Enter video device interface. See Figure 4-16.

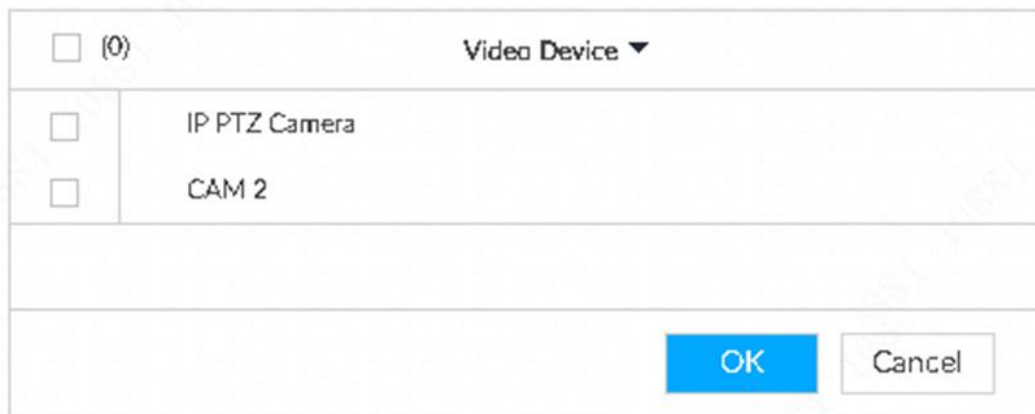

(0) Video Device ▼

IP PTZ Camera

CAM 2

OK Cancel

Figure 4-16

3. Select a channel you want to add.  
Click  and then input the key words, it can quickly search the channel you want to add.
4. Click OK to add the select channels.



Step 6 Click Continue to add or Finish.

- Click Continue to add, device goes back to Smart add interface to add more remote device.
- Click Finish to complete add remote device process. Device displays device manager interface to view the newly added remote device information.

#### 4.4.2 Manual Add

For some remote devices, you can input IP address, user name, and password to register. It is so called manual add.

#### Steps

Step 1 On setting interface click , or click  and then select Device.  
Enter device manager interface.

Step 2 Click  and then select Manual add.  
Enter manual add interface. See Figure 4-17.

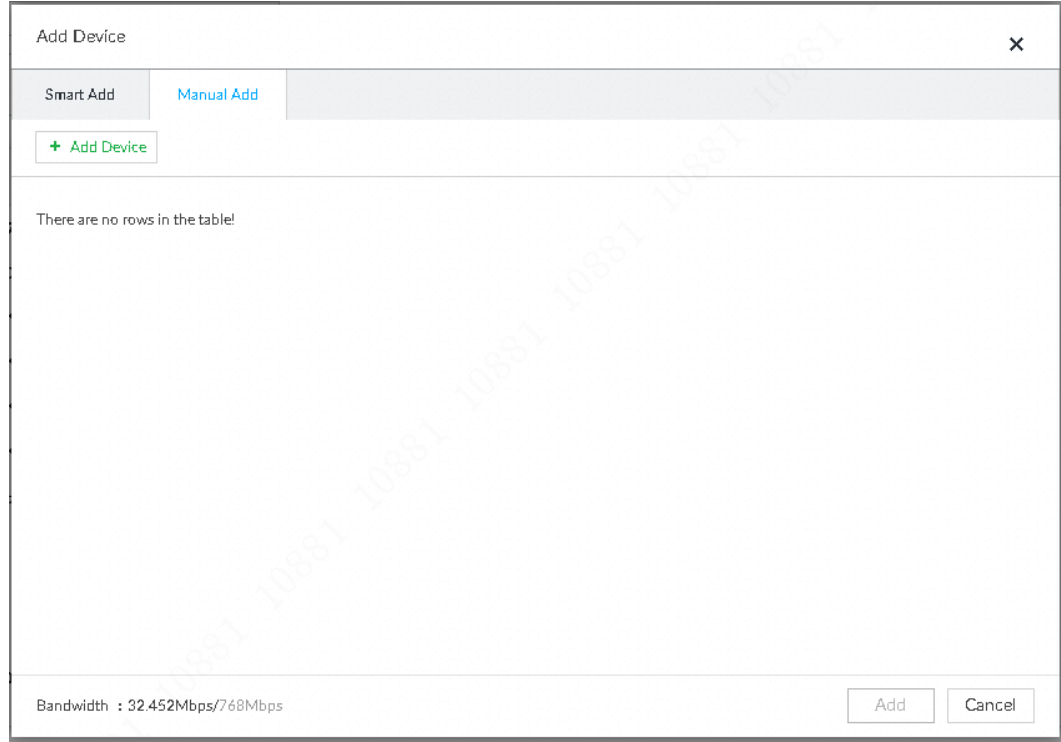

Figure 4-17

Step 3 Click Add device button.  
Device pops up interface for you to input remote device information. See Figure 4-18.



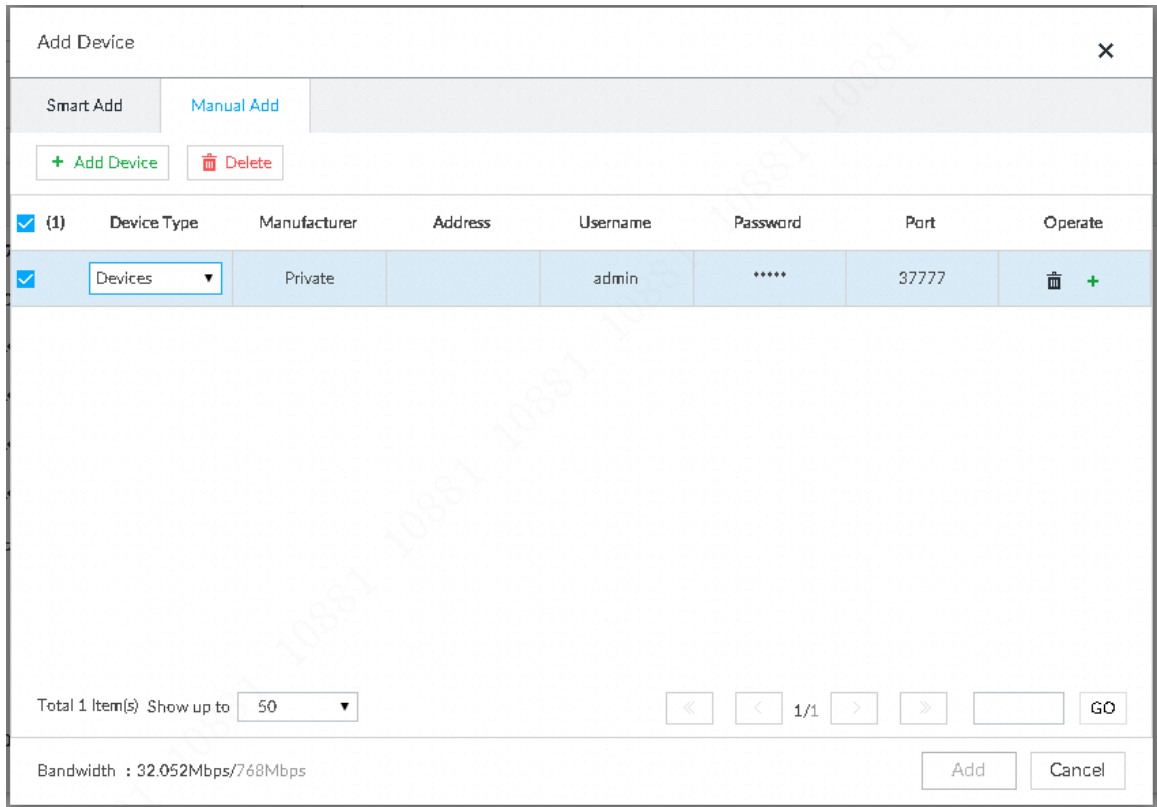



Figure 4-18

Step 4 Set parameters.

Name	Function
Device type	It is to select remote device type. The default type is Devices.
Manufacturer	Select remote device connection protocol.
Address	Input remote device IP address.
User name	Input remote device user name and password.
Password	
Port	Input port number.
Operation	<p>Delete current line or add a new line.</p> <ul style="list-style-type: none"> <li>Click  to delete current line information.</li> <li>Click  to add a new line. Input remote device information to add several devices at the same time.</li> </ul>

Step 5 Add remote device.

- Add 1-channel remote device.

Select remote device and then click Add bottom. Device begins add remote device and pops up confirmation interface. See Figure 4-19.

 **Note**

During the adding process, click Cancel button, you can cancel adding process. Click the stop button of the corresponding remote device to cancel add.

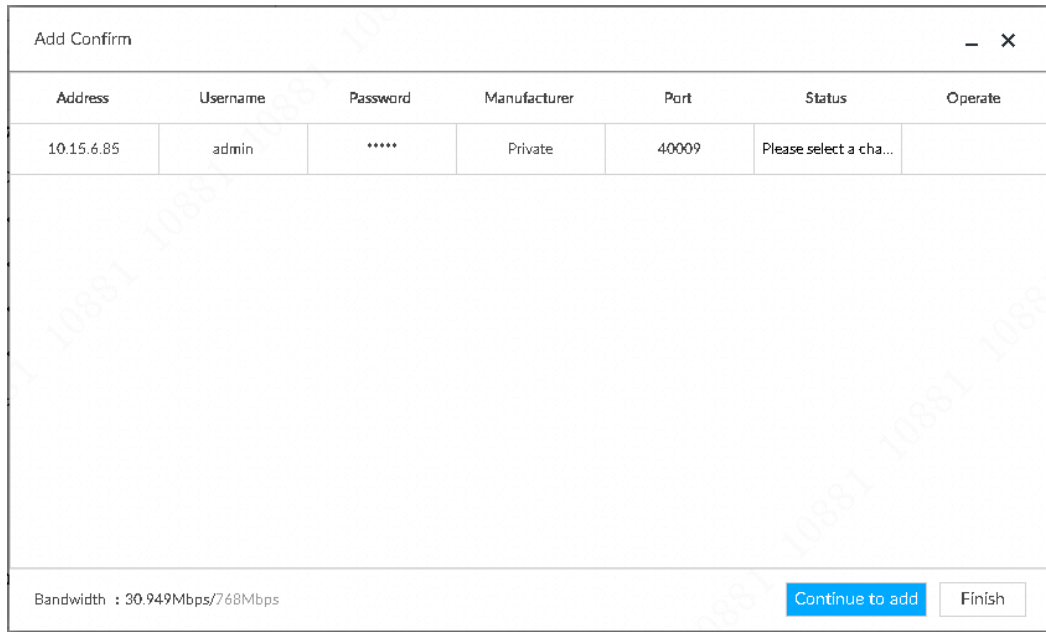

Address	Username	Password	Manufacturer	Port	Status	Operate
10.15.6.85	admin	*****	Private	40009	Please select a cha...	

Bandwidth : 30.949Mbps/768Mbps

[Continue to add](#) [Finish](#)

Figure 4-19

Name	Function
Address	It is to display remote device IP address.
User name	It is to display remote device user name and password.
Password	System default user name is <b>admin</b> and password is <b>admin</b> . The register operation may fail if the system user name or password is not the same with the remote device.
Manufacturer	It is to display manufacturer information.
Port	It is to display remote device port number.
State	It is to display system and remote device connection status.
Operation	<p>If system fails to add the remote device, refer to the reason on the Status column to change the remote device information and then click Retry to try to add again.</p> <p> <b>Note</b>            Double click remote device IP address, user name, password, manufacturer, port to change corresponding information.</p>

- Add multiple-channel remote device
  1. Click Add button.  
Enter add confirmation interface. See Figure 4-20.

Add Confirm						
Address	Username	Password	Manufacturer	Port	Status	Operate
10.15.6.85	admin	*****	Private	40009	Please select a cha...	

Bandwidth : 30.949Mbps/768Mbps

[Continue to add](#) [Finish](#)

Figure 4-20

2. Double click select a channel.  
Enter video channel interface See Figure 4-21.

<input type="checkbox"/> (0)	Video Device ▼
<input type="checkbox"/>	IP PTZ Camera
<input type="checkbox"/>	CAM 2

[OK](#) [Cancel](#)

Figure 4-21

3. Select channel(s) you want to add.  
Click  and then input the key words, it can quickly search the channel you want to add.
4. Click OK to add the select channels.

Step 6 Click Continue to add or Finish.

- Click continue to add, device goes back to Smart add interface to add more remote device.
- Click Finish to complete add remote device process. Device displays device manager interface to view the newly added remote device information.

## 5 Operations

It is to introduce general operations such as preview and monitor, playback, alarm, AI function, operation and maintenance management.

### 5.1 Login IVSS

After boot up device, please input the corresponding user name and password to login.



#### Note

After initialize the device, you have logged in by default. Now you can set system settings and operate.

#### Steps

Step 1 Boot up device.

Enter login interface. See Figure 5-1.





Figure 5-1

Step 2 Input user name and password.



#### Note

- Default user name is **admin**. The password is that you set during initialization process. For your device safety, please change the **admin** password regularly and keep it well.
- After input password, use mouse to press  to display password. Release mouse or move mouse to  other position, the password is displayed at hidden mode again.
- Move the mouse to the  to view the password prompt information. It is to help you remember password.
- In case you forgot password, click Forgot password to reset. Refer to chapter 6.6.2.4 Reset password for detailed information.

Step 3 Click Login

Enter main interface. See Figure 5-2.

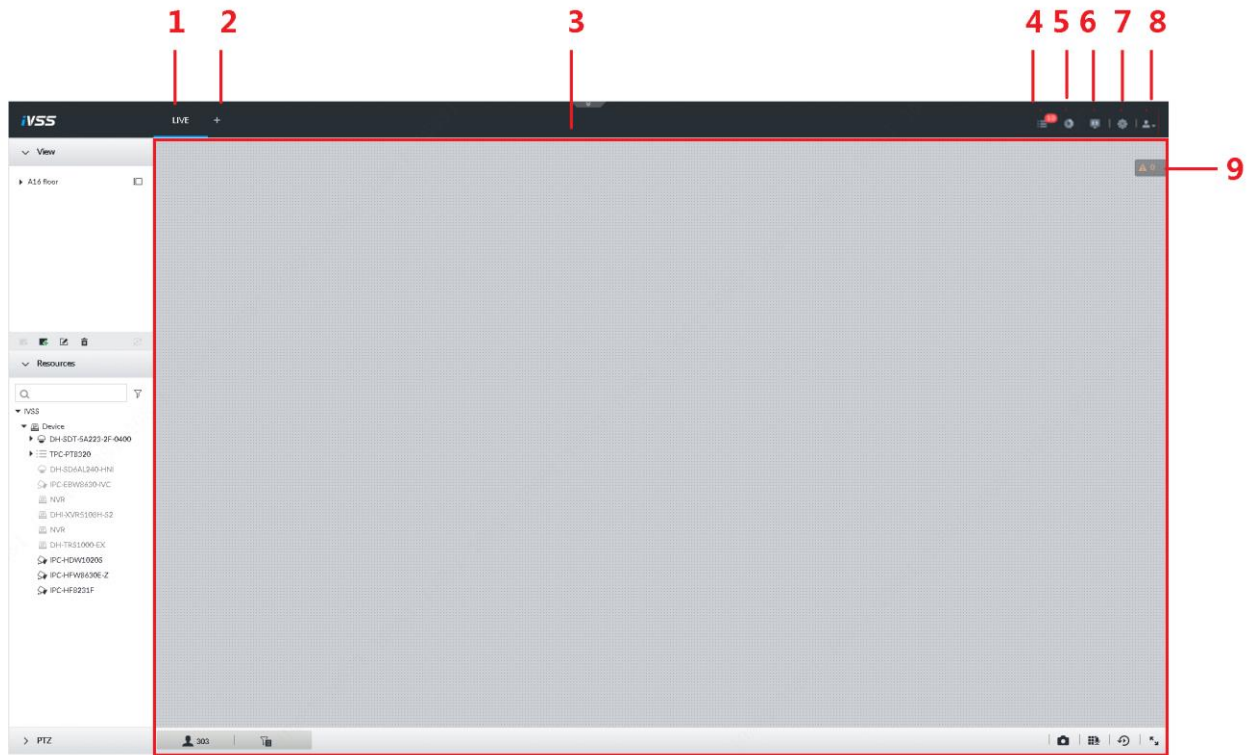





Figure 5-2

SN	Name	Function
1	Task column	It is to display enabled application icon. Move the mouse to the app and then click  to close the app.  <b>Note</b> The preview function is enabled by default and cannot be closed.
2	Add icon	Click to display or hide app interface. On app interface to view or enable appl.
3	Operation interface	It is to display currently enabled app operation interface.
4	System info	Click to view system information. Refer to chapter 5.8 System info for detailed information.
5	Background task	Click to view the background running task information. Refer to chapter Background tasks for detailed information.
6	Multiple-screen control	Click to control the local screen. Refer to chapter 5.5.1 Multiple-screen control for detailed information.  <b>Note</b> This function is for local menu only.
7	System settings	Click to enter system setting interface. Refer to chapter 6 System settings for detailed information.
8	Login user	Click it to change user password, lock user, logout user, reboot device or close device.  <b>Note</b> Reboot and shut down function is for local menu only.

SN	Name	Function
9	Alarm list	It is to display currently unprocessed alarm event amount. Click the icon to view detailed alarm information. Refer to chapter 5.4 Alarm list for detailed information.

## 5.2 Preview and Monitor

After logged in the device, system displays Live interface by default. See Figure 5-3.



### Note

Move the mouse to the middle of the video play window and the column bar on the left side, device

displays . Click the to hide the column bar on the left side. See Figure 5-4.

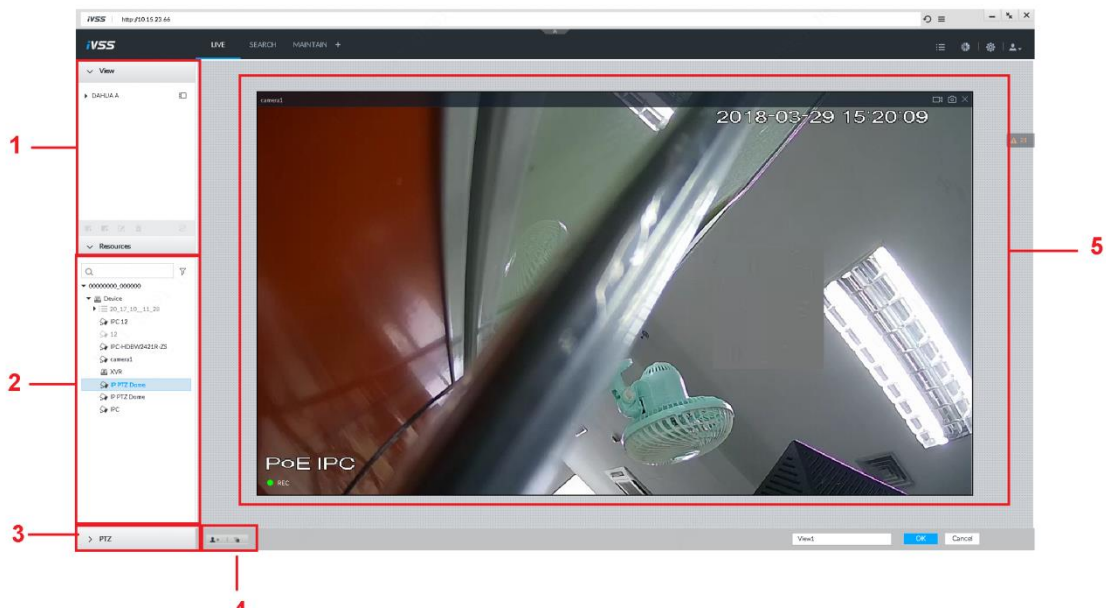

Figure 5-3



Figure 5-4

Name	Function
1	View zone. It is to display the created view and view group. Refer to chapter 5.2.1 View management for detailed information.
2	Registered remote device list. Refer to chapter 5.2.2 Resource Pool for detailed information.

Name	Function
3	PTZ zone. PTZ control pane. Refer to chapter 5.2.3 PTZ for detailed information.
4	Intelligent preview icon. Refer to chapter 5.2.4 Preview for detailed information.
5	Video play window. Refer to chapter 5.2.1.3 View window for detailed information.

### 5.2.1 View Management

View is a video component of several remote devices. Go to the view pane at the top left corner of the Live interface to view or call the view. See Figure 5-5.

- System has created Views group by default. Please create view or view group under the View.
- Double click the view or drag the view to the play pane on the right side, device begins play the real-time video from the remote device.
- Click  to select Views and its sub-node.

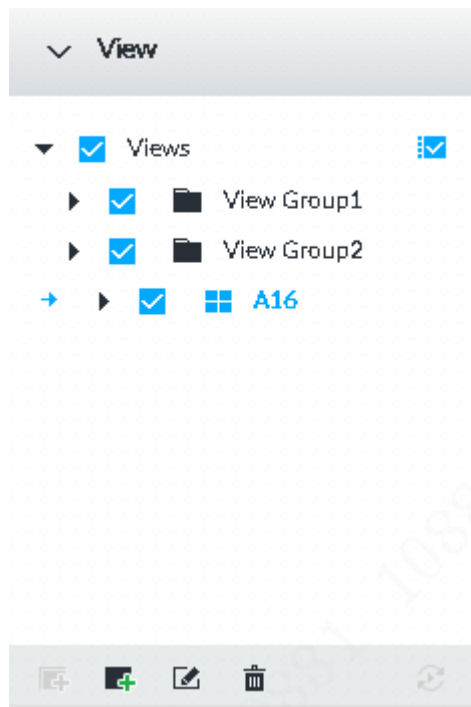

Figure 5-5

#### 5.2.1.1 View Group

View group is a group of views. The view group allows you to categorize and manage view. It is easy for you to search and find the view.



#### Note

Device max supports 100 view groups.

##### 5.2.1.1.1 Create view group

It is to create view group under the Views.

The views hierarchy shall not be more than 2. For example, after create View Group 1 under View, you can create a sub-level View Group 2 under View Group 1. However, you cannot create sub-level group under View Group 2.

#### Steps

Step 1 Follow the steps listed below to create a view group.

- Select Views or created view group and then click .

- Right click Views or the created view group, select create new view group. System creates one view group. See Figure 5-6.

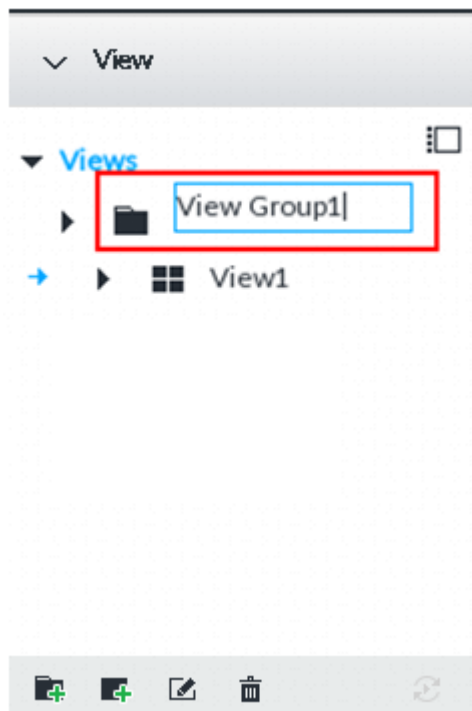

Figure 5-6

Step 2 Set view group name.

The view group name ranges from 1 to 64-digital. It can contain English letters, number and special character.

Step 3 Click any spare pane on the interface.

Device pops up successfully operated.

#### 5.2.1.1.2 Rename view group

View group is to classify or category different view groups. We recommend the view group name shall be easy to recognize.

### Steps

Step 1 Follow the steps listed below to set view group name as editable.

- Select a view group and then click .
- Right click view group, and then select Rename. See Figure 5-7.



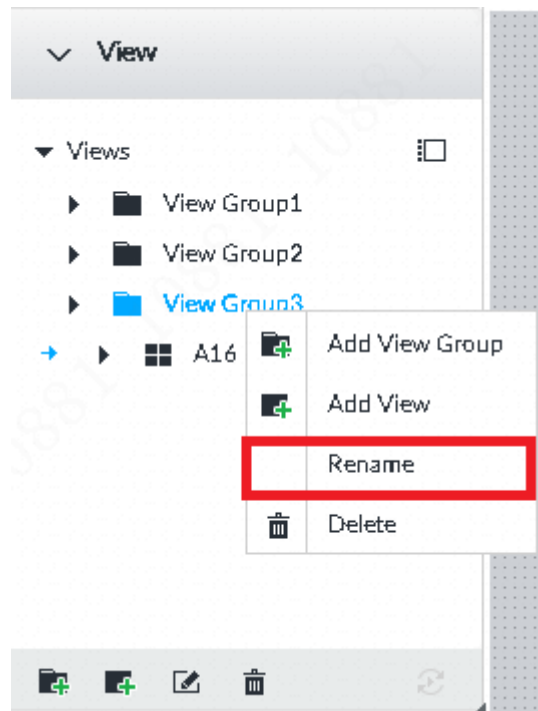

Figure 5-7

Step 2 Set view group name.

The view group name ranges from 1 to 64-digital. It can contain English letters, number and special character.

Step 3 Click any spare pane on the interface.

Device pops up successfully operated.

#### 5.2.1.1.3 Delete View group



#### Warning

Once you delete view group, all views under current view group will be deleted at the same time. Please be careful!

Follow the steps listed below to delete view group.

- Select view group and click 
- Right click view group and then select Delete.

#### 5.2.1.2 View

View is a group of video combination from several remote devices. You can drag several remote devices to the same view and when view function is enabled, you can view the real-time video from several remote devices at the same time.

##### 5.2.1.2.1 Create View

Create view is to add several associated remote devices to the same View. It is easy to view the real-time video from several remote devices at the same time.

#### Preparation

Before you create view, please make sure you have added the remote device. Refer to chapter 4.4 Register remote device for detailed information.

## Steps

Step 1 Follow the steps listed below to create view.

- Select a view group and then click , select Add view.
- Right click a view group, select Add view.  
Enter edit view interface. See Figure 5-8.

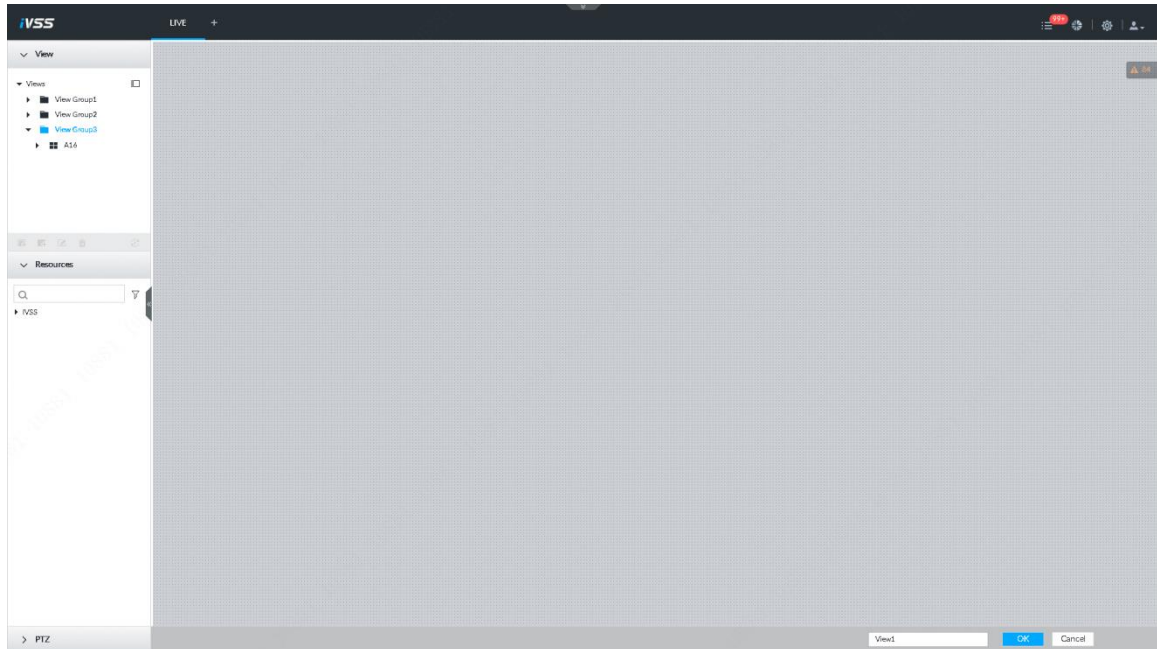



Figure 5-8

Step 2 Double click a remote device on the device tree, or drag the remote device to the right pane. After added one remote device, the view edit pane displays layout split line. See Figure 5-9.

- Each layout grid supports one remote device. If you want to add several remote devices, please drag the rest remote device to other idle layout grid.
- If the layout grid has added the remote device, drag another remote device to current grid is to replace the original one.
- Move the mouse to the orange pane (such as ) of the view window, press the view window and then drag after you see the arrow icon. It is to adjust view window size.

### Note

- Device automatically creates the view grids amount according to the select remote device amount. Device max supports 36 view windows.
- Device automatically allocates the view window size according to the remote device resolution by default. If the device cannot get the remote device resolution or the remote device has no resolution, device automatically adjust view window size according to remote device amount and playback pane.
- When adjusting view window position, please drag the view window to the layout grid of the green background color. Cannot drag the view window to the layout grid if its background color is orange.

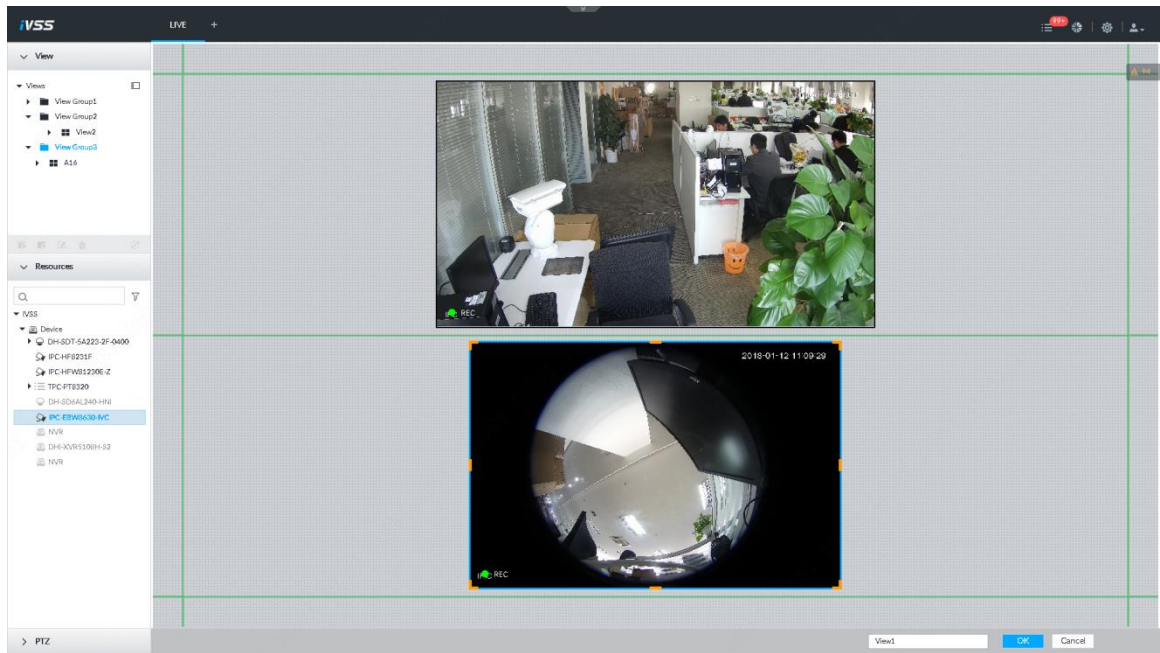

Figure 5-9

Step 3 Set view name.

The view group name ranges from 1 to 64-digital. It can contain English letters, number and special character.

Step 4 Click OK to save settings.

System pops successful interface.

#### 5.2.1.2.2 Edit View

In edit view mode, it supports following functions:

- Add, delete the remote device on the view.
- Adjust the view grid display.
- Modify view name.

### Steps

Step 1 Right click View and then select Edit.

Enter view edit interface. See Figure 5-10.

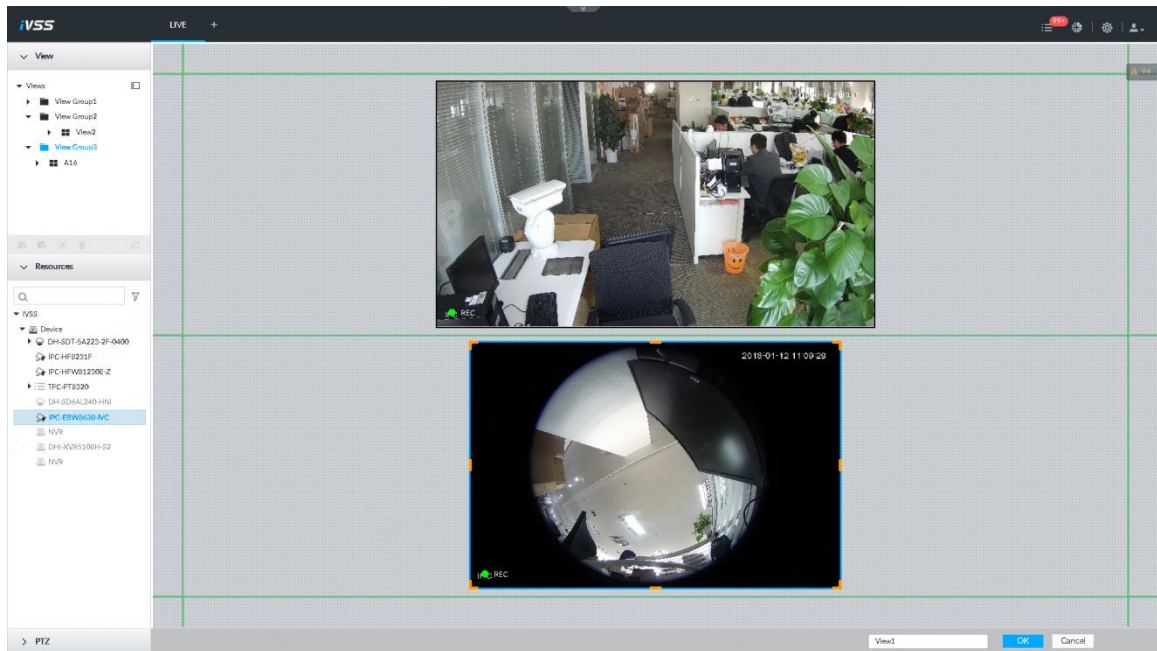



Figure 5-10

Step 2 Edit view as your requirement.

- Add remote device: Double click remote device on the device tree, or drag the remote device to the free layout grid on the right pane.
- Delete remote device: Select a remote device and then click the  at the window top right corner.
- Move window position: Select a window, move the window to the proper position and release mouse.
- Change window position: Press one view window and then drag to another view window.
- Change window size: Move your mouse to the orange pane on the window. Press and drag the view window after you see the arrow icon.
- Change view name: Set view name on .

 **Note**

When you are adjusting view window position, you can only drag the view window to the grid of green background color. You cannot drag the view window to the grid of red background color.

Step 3 Click Save to save settings.

System pops successful interface.

#### 5.2.1.2.3 Enable view

Follow the steps listed below to enable view.

- Right click view and then select Open.
- Double click view.

Enter view window. See Figure 5-11.

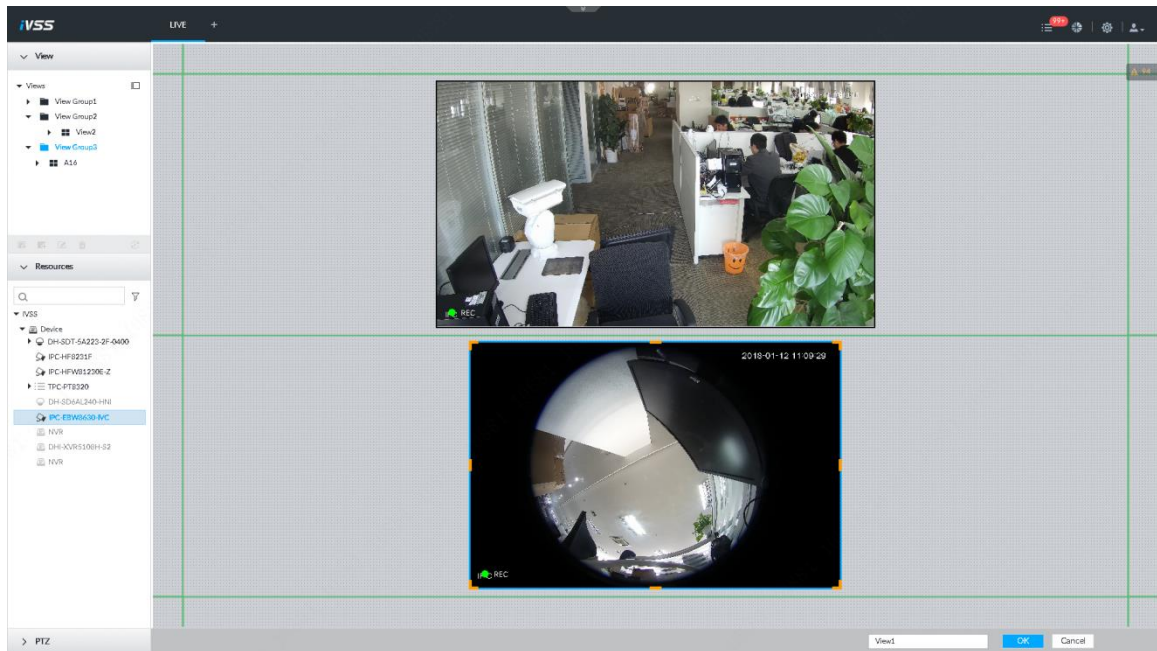

Figure 5-11

When enable the view, you can change video position, zoom video window ,etc.



**Note**

When you are adjusting view window position, you can only drag the view window to the grid of green background color. You cannot drag the view window to the grid of red background color.

Move your mouse to the view window, device displays window task column. You can snapshot view or close video window. Refer to chapter 5.2.1.3.1 Window task column for detailed information.

Right click view window, you can switch bit streams, set digital zoom ,etc. Refer to chapter 5.2.1.3.2 Right-click menu for detailed information.

Name	Function
Exchange window position	<p>Press one view window and drag it to the another view window, it is to exchange these view window position.</p> <p> <b>Note</b> The exchanging window position operation is valid only once. Disable and then enable view again, the view window restore original position. If you want to change view window position permanently. Please go to the view edit mode to set. Refer to chapter 5.2.1.2.2 Edit view for detailed information.</p>
Zoom in video window	<ul style="list-style-type: none"> <li>Once current view window amount is too much(more than 9),click one view window, device displays current view window at the center of the window in the zoom in mode. Click any other blank position, you can view window restores original size.</li> <li>Double click a view window, device displays view window at one window. Double click view window again or click any blank position, the view window restores original size.</li> </ul>

Name	Function
Zoom in Window	When there are too much video windows (more than 9),click one video window, system display selected window at the center. Click any other position, the selected window restore original size. Double click a video window, system displays selected window at one-screen mode. Double click the selected window again or click any other position to restore original window display mode.
Add view window	On the device tree, double click the remote device or drag the remote device to the right pane, you can add remote device to current view. Drag the remote device to the view window to replace the original remote device. <b>Note</b> The modified view layout is valid only for once if you do not click OK button. Close and enable view again, the view layout restores original layout.
Close view window	Move the mouse to one view window, click  to close the view window. <b>Note</b> Close view window, device automatically adjusts view layout according to the rest remote device amount and play pane free space.

#### 5.2.1.2.4 Rename view

Step 1 Follow the steps listed below to enable view.

- Select a view, click .
- Right click view, select Rename. See Figure 5-12.

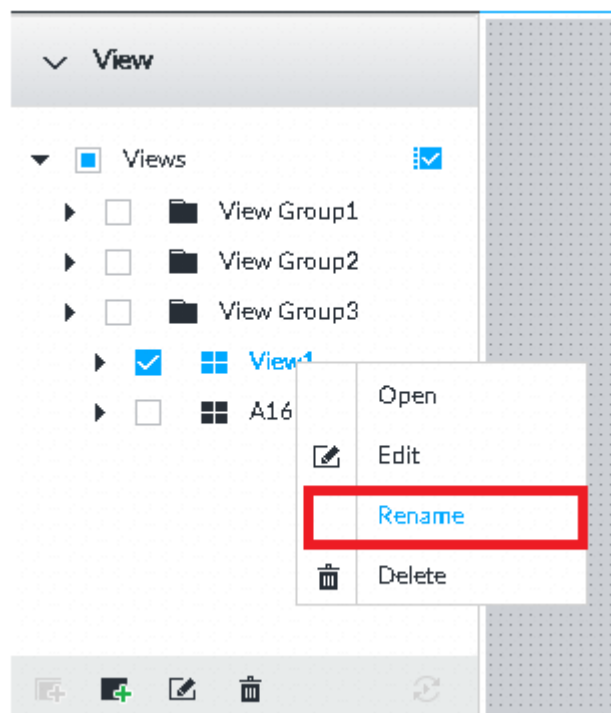

Figure 5-12

Step 2 Set view name.

The view group name ranges from 1 to 64-digital. It can contain English letters, number and



special character.

Step 3 Click Save to save settings.

System pops successful interface.

#### 5.2.1.2.5 Delete view

Delete view, system supports to delete View one by one or batch delete.

- Delete one by one: Select a view and then click , right click view and then select Delete.
- Batch delete: Click , select views you want to delete and then click .

#### 5.2.1.3 View window

Right click view, and then click Open or double click view, enter view window. See Figure 5-13.

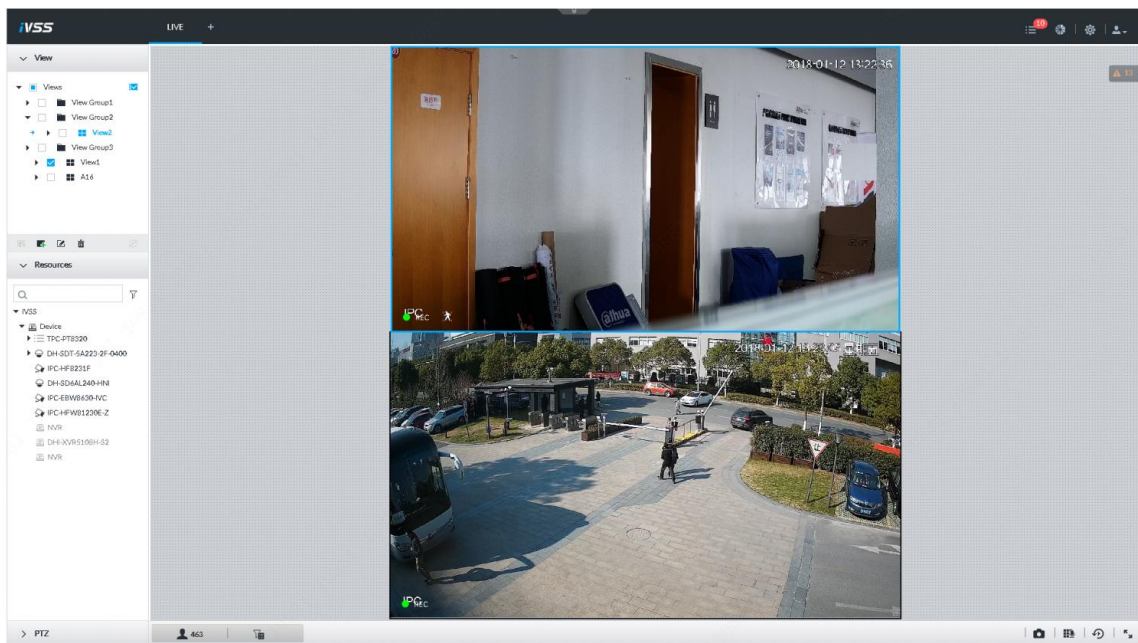





Figure 5-13

#### 5.2.1.3.1 Window task column

Move the mouse to the view window, device displays window task column. See Figure 5-14.

- Click  to start recording manually. Now the icon becomes . Click  to stop recording.

#### Note

System stops recording according to the manual record length settings if you do not click  again to stop. Refer to chapter 6.2.2.4.5 Set storage plan for detailed information.



- Click  to snapshot.
- Click  to close view window.



Figure 5-14

### 5.2.1.3.2 Right click menu

Right click view window, enter right-click menu interface. See Figure 5-15.

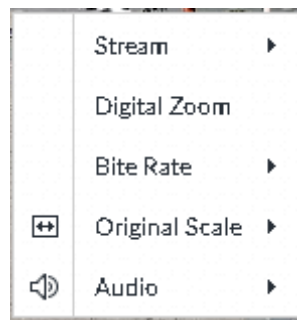

Figure 5-15

Name	Function
Stream	It is to set current window stream. It includes: main stream/sub stream 1/sub stream 2.
Digital zoom	It is to set digital zoom.
Bit rate	Display remote device real-time bit rate or not. See Figure 5-16.
Original scale	It is to set video window scale. <ul style="list-style-type: none"> <li>On: System automatically adjusts video window scale according to the resolution.</li> <li>Off: System automatically adjusts video window size according to remote device amount and play window spare pane.</li> </ul>
Audio	It is to set audio output. It includes audio 1, audio 2, mixing and off.



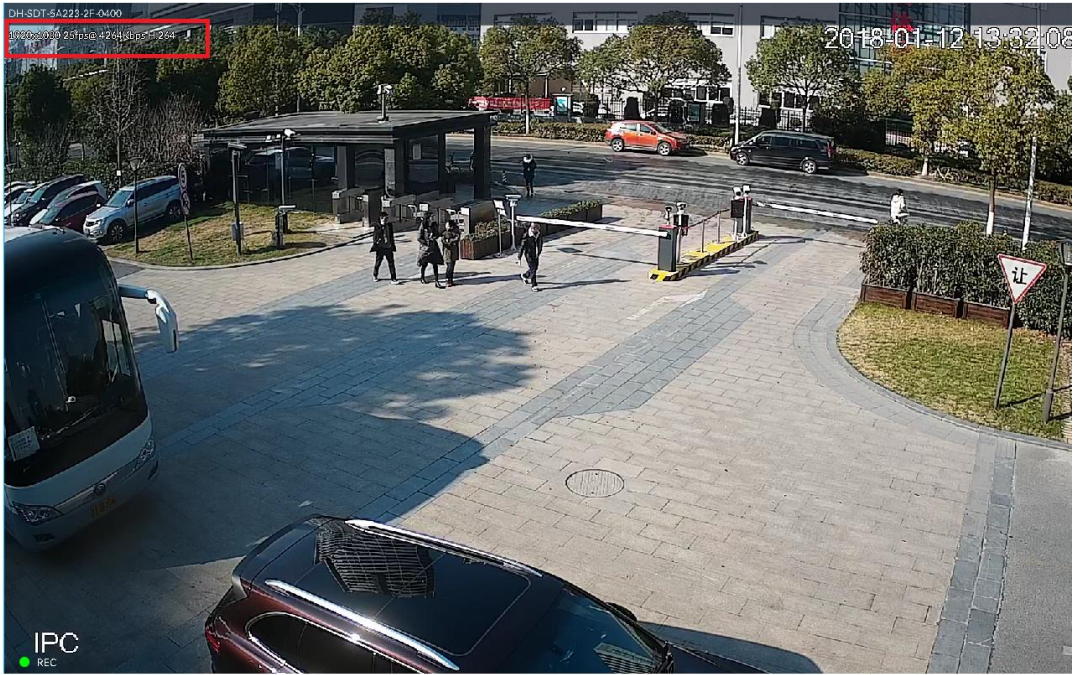

Figure 5-16

### 5.2.1.3.3 Digital Zoom

The digital zoom function allows you to zoom in a specified zone to view the video details.

After enable the video, right click mouse and then select Digital zoom->On, select a zone you want to zoom in on the video window. The selected zone becomes zoom in. See Figure 5-17.

- In zoom in status, press any position on the video window and then drag, you can view the zoom in effect of other zone.
- Select a zone you want to zoom in on the video window again, system zoom in the zone at the larger rate.
- Right click mouse and then from digital zoom->Off, it is to cancel zoom in effect. The video restores original effect.

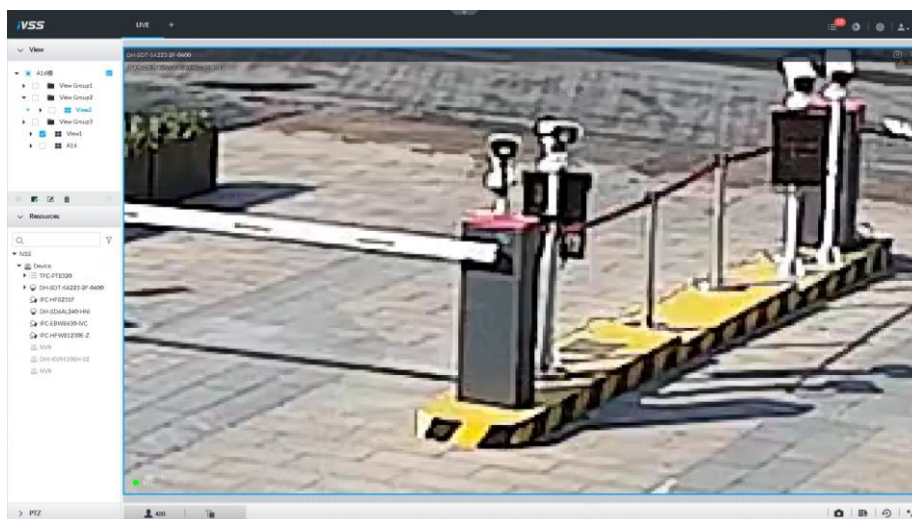

Figure 5-17

## 5.2.2 Resources Tree

Resources tree is to display the registered remote device list. Device automatically categorizes the

device type. See Figure 5-18.

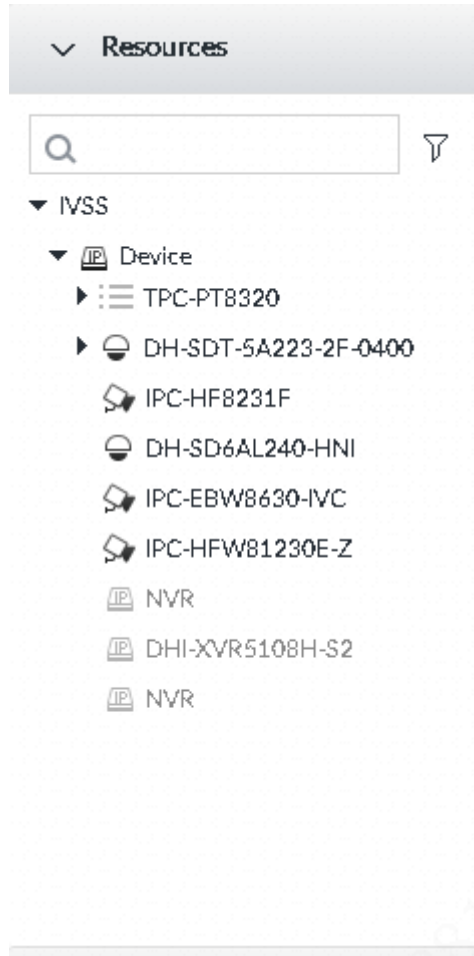









Figure 5-18

Name	Function
Search device	Input key words at  , device displays the corresponding remote devices.  <b>Note</b> Support fuzzy search
Filter device	Click  and then select all, online, offline. It is to filter the disqualified remote device.

Name	Function
View device status	<p>Display remote device status on the resources pool.</p> <ul style="list-style-type: none"> <li>● The remote device name and icon is black. It means the remote device is online. For example:  IP PTZ Camera .</li> <li>● Remote device name and icon is grey. It means the remote device is offline. For example  HCVR0404AH-VFD .</li> <li>● There is an icon  before the remote device. It means remote device is abnormal, alarming ,etc. Move the mouse to the  to view the detailed information.</li> </ul>
Mouse operation	<ul style="list-style-type: none"> <li>● Move the mouse to the remote device name, you can view remote device IP address and port number.</li> <li>● On the device list, click one remote device and then press <b>【Ctrl】</b> , click other remote device, you can select several remote devices at the same time.</li> <li>● On the device list, select one remote device and then press <b>【Shift】</b>, click other remote device, select current two remote devices and all remote devices listed between them.</li> <li>● Double click remote device or drag the remote device to the view window on the right pane, you can enter edit view interface. Refer to chapter 5.2.1.2.2 Edit view for detailed information.</li> </ul>

### 5.2.3 PTZ

Control the PTZ, you can move the PTZ at all directions, lens zoom in/zoom out, focus control, etc. In this way, it can display PTZ at all angles from different positions.

The PTZ operation pane is at the top right corner of the preview interface. See Figure 5-19.



#### Note

The following figure for reference only. The grey button means current function is null.

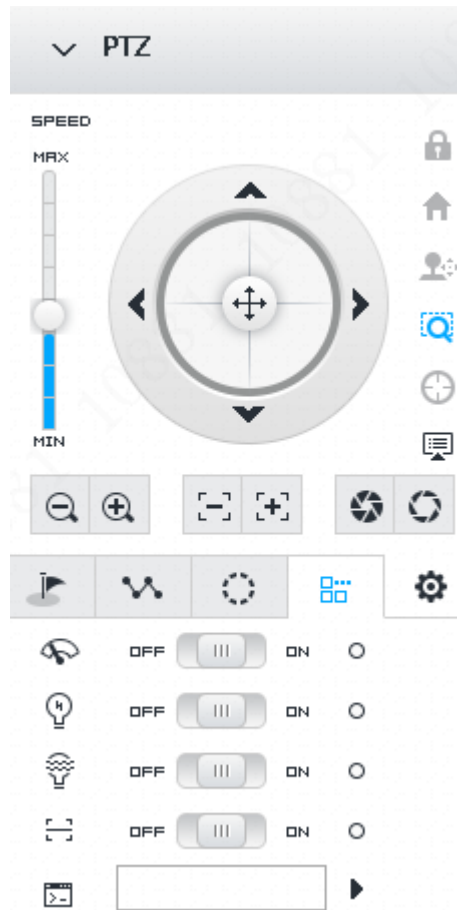









Figure 5-19

Name	Function
	It is to set PTZ speed. The higher the value is, the faster the PTZ speed is.
	It is to control PTZ movement. <ul style="list-style-type: none"> <li>Click  to control PTZ top/bottom/left/right/top left/top right/bottom left/bottom right direction.</li> <li>Click , ,  or , it is to control PTZ top/bottom/left/right direction.</li> </ul>
	Click to enable 3D positioning function.
	Click to enter PTZ menu mode. Refer to chapter 5.2.3.1 PTZ setting menu for detailed information.
	Zoom. Click to adjust lens zoom rate of the remote device.

Name	Function
	Focus. Click to adjust lens focus of the remote device.
	Iris. Click it to adjust iris size of the remote device.
	<p>Click to enter PTZ call interface.</p> <p> <b>Note</b> Go to the remote device to set corresponding PTZ function before you call it.</p> <ul style="list-style-type: none"> <li>Click  to enter preset call interface. Refer to chapter 5.2.3.2.1Call preset for detailed information.</li> <li>Click  to enter call tour interface. Refer to chapter 5.2.3.2.2Call tour for detailed information.</li> <li>Click  to enter call pattern interface. Refer to chapter 5.2.3.2.3Call pattern for detailed information.</li> </ul>

### 5.2.3.1 PTZ Menu Settings

Enable PTZ menu function, device displays PTZ main menu, on the view window. The PTZ main menu includes camera settings, PTZ settings, system management, etc. Use direction button and confirm button to set the remote device.

 **Note**

PTZ menu function is for remote device that supports PTZ function only.

#### Steps

Step 1 Enable view and then select a remote device on the view.

Step 2 ON PTZ pane, click .

Enter PTZ menu interface. See Figure 5-20.

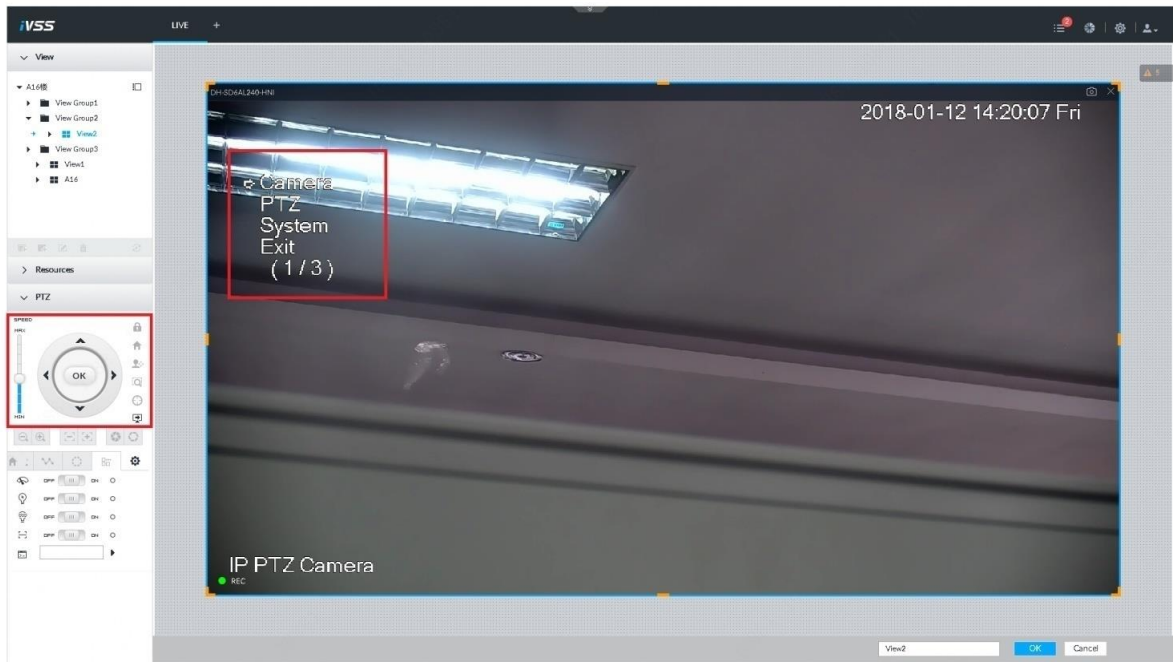

Figure 5-20

Name	Function
Camera	Enter camera interface, you can set remote device image parameters. It includes picture, exposure, backlight, WB, day and night, focus and zoom, defog, default ,etc.(different series products have different menu items.)
PTZ	Enter PTZ interface, you can set remote device PTZ function. It includes preset, tour, scan, pattern, rotation, PTZ restart ,etc.
System	Enter system interface., you can set remote device PTZ simulator, restore default, manage remote device peripheral device, view remote device software version, PTZ version ,etc.
Exit	Exit PTZ menu interface.

Step 3 Set PTZ menu parameters.

- Click or , it is to control mouse directions.
- Click or , it is to set items parameters.
- Click to confirm current items.
- When there is sub-menu of the item on the main menu, move the mouse to the current item and then click , enter sub-menu interface.
  - ✧ Move mouse to the Back and then click , return upper-level menu.
  - ✧ Move mouse to the Exit and then click , exit PTZ menu.

Step 4 Click to exit PTZ menu mode.

5.2.3.2 Call PTZ function

It is to call PTZ function, control PTZ device to implement corresponding operations.



**Note**

Different PTZ devices support different PTZ functions. Refer to the actual interface for detailed information.

5.2.3.2.1 Call preset

Preset function is to save the address information (such as PTZ pan/tilt, focus, etc.) to the memory so that you can quickly adjust the dome and PTZ to the correct position.

**Steps**

Step 1 Click

Enter call preset interface. See Figure 5-21.

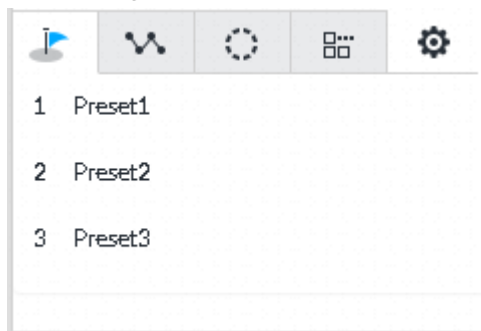

Figure 5-21

Step 2 Move the mouse to the preset name.

The displays at the right side of the preset name.

Step 3 Click .

PTZ device goes to the corresponding position.

5.2.3.2.2 Call cruise

Add presets into a routine in a desired order and then set time and stop duration for each address. The dome will begin an auto cruise between these presets.

**Steps**

Step 1 Click

Enter call cruise interface. See Figure 5-22.

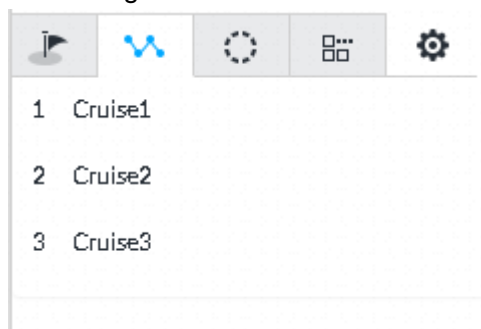



Figure 5-22

Step 2 Move the mouse to the cruise name.

The  displays at the right side of the cruise name.

Step 3 Click .

PTZ device calls cruise path and go to the presets at the specified order and interval.

Step 4 Click  to stop calling cruise.

#### 5.2.3.2.3 Call pattern

Memorize dome operation such as pan, tilt, and zoom to repeat. You can call it to repeat the previous operation.

### Steps

Step 1 Click .

Enter call pattern interface. See Figure 5-23.

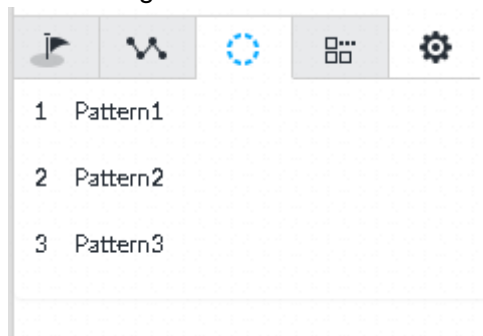



Figure 5-23

Step 2 Move the mouse to the pattern name.

The  displays at the right side of the pattern name.

Step 3 Click .

PTZ device calls pattern and move back and forth according to the settings.

Step 4 Click  to stop calling pattern.

### 5.2.4 Preview

After enable AI detection function, go to the preview interface to view AI detection results.

#### Note

Refer to chapter 6.4.1.3 Global AI detection to enable AI detect function.

Go to the Live interface, enable view, device displays view video. See Figure 5-24.

- The view window displays currently detected human face rule rectangle.
- The view window displays properties pane such as human face detected image and human face comparison results on the right pane.



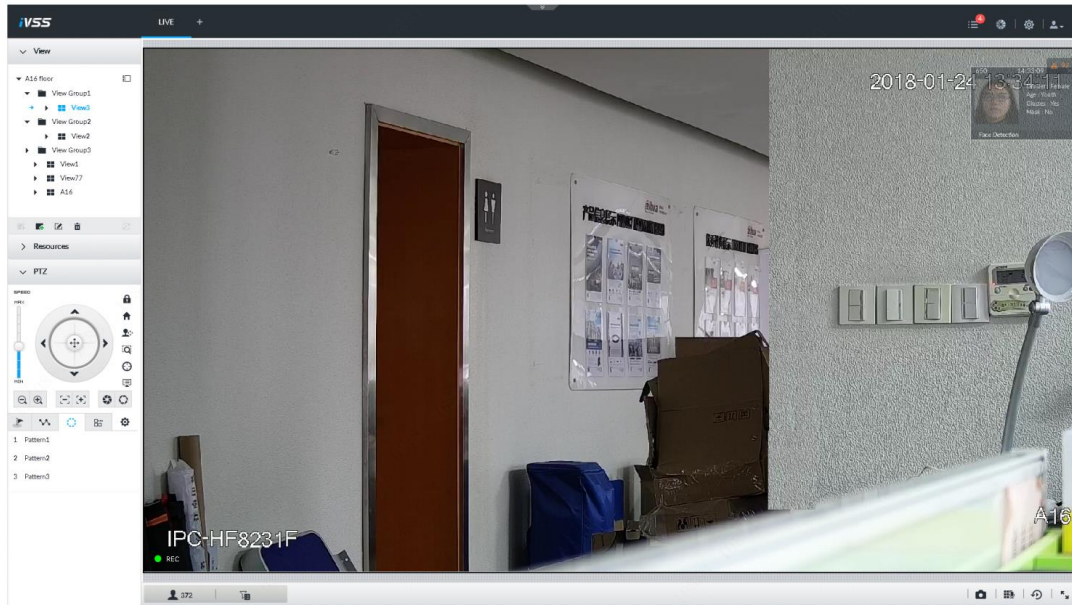

Figure 5-24

### 5.2.4.1 View image

On preview interface, click to view AI detection image. See Figure 5-25.

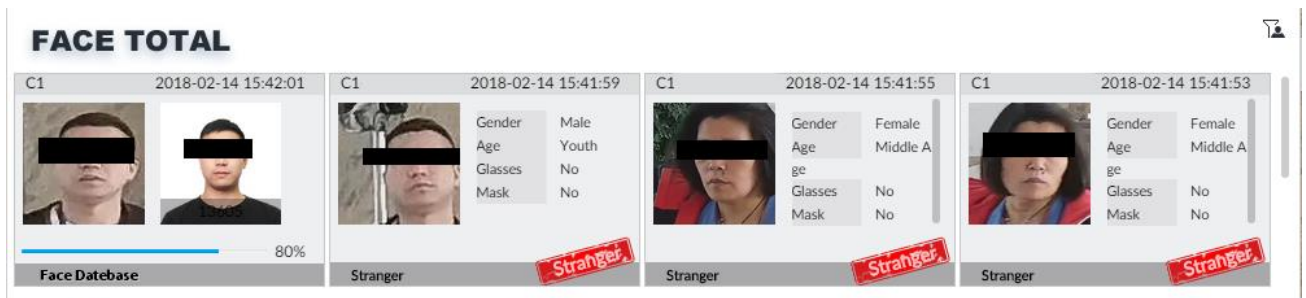

Figure 5-25

Click to filter the Ai detection mode. See Figure 5-26

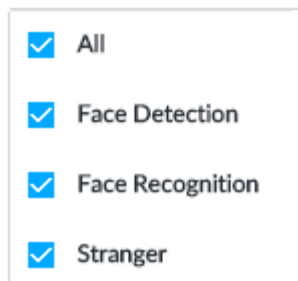

Figure 5-26

Double click AI detection image, system displays the the 20 seconds video before and after the image.

Click to pause play. Now the icon becomes , click to continue play.

Click to exit record interface. See Figure 5-27.

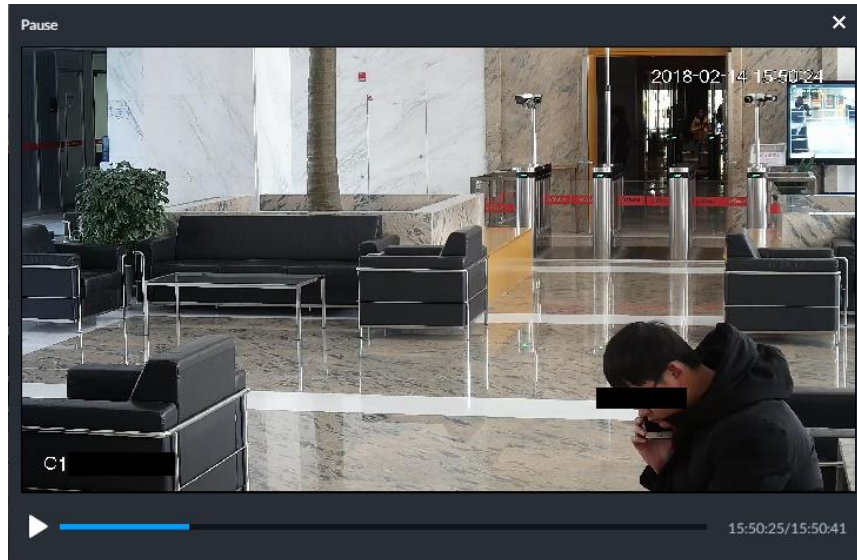

Figure 5-27

#### 5.2.4.2 AI display settings

It is to set AI detection results displayed rule.

#### Steps

Step 1 On the preview interface, click .

Enter human face interface. See Figure 5-28.

#### Note

- Click Sync from AI-DIs, you can get global intelligent detection display rule from the device directly. Refer to chapter 6.4.1.3.2 AI display for detailed information.
- Click Apply to all windows, it is to copy current configuration to other window(s).

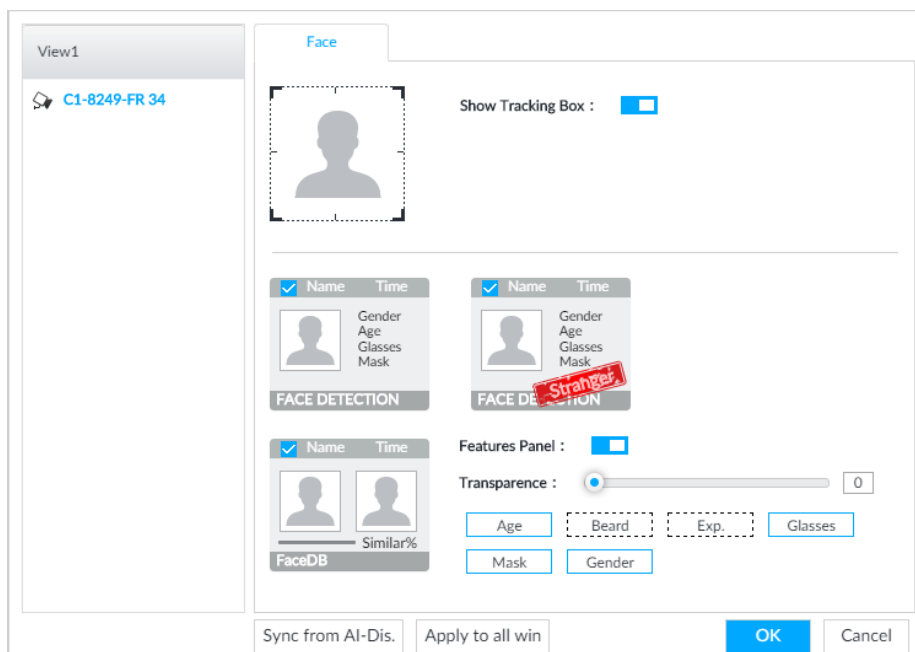



Figure 5-28

Step 2 Enable Tracking box.

After enable tracking box function, there is a tracking box near the human face on the video window.

Step 3 Enable features panel, and select features you want to display on the preview window.

After enable the features panel function, there is a features panel on the right side of the video window.

- Press  and then drag to the left or the right, you can adjust features panel transparency. The higher the value is, the more transparent the features panel is.
- The features panel maximally supports four features.
- System has checked four features by default. If you want to select other item, please cancel one item and then select again.
- Click  to display features panel or not on the preview interface. It includes human face detection panel, stranger panel, and human face comparison panel.

Step 4 Click Ok to save settings.

## 5.3 Search

It is to search or playback the record file or image on the device. At the same time, you can export record file or image to the USB device or local PC.

### 5.3.1 Playback Record File

Search and playback record file according to remote device, record type, and record time.

#### Steps

Step 1 On the Live interface, click  and then select Search.

Enter Search interface. See Figure 5-29.

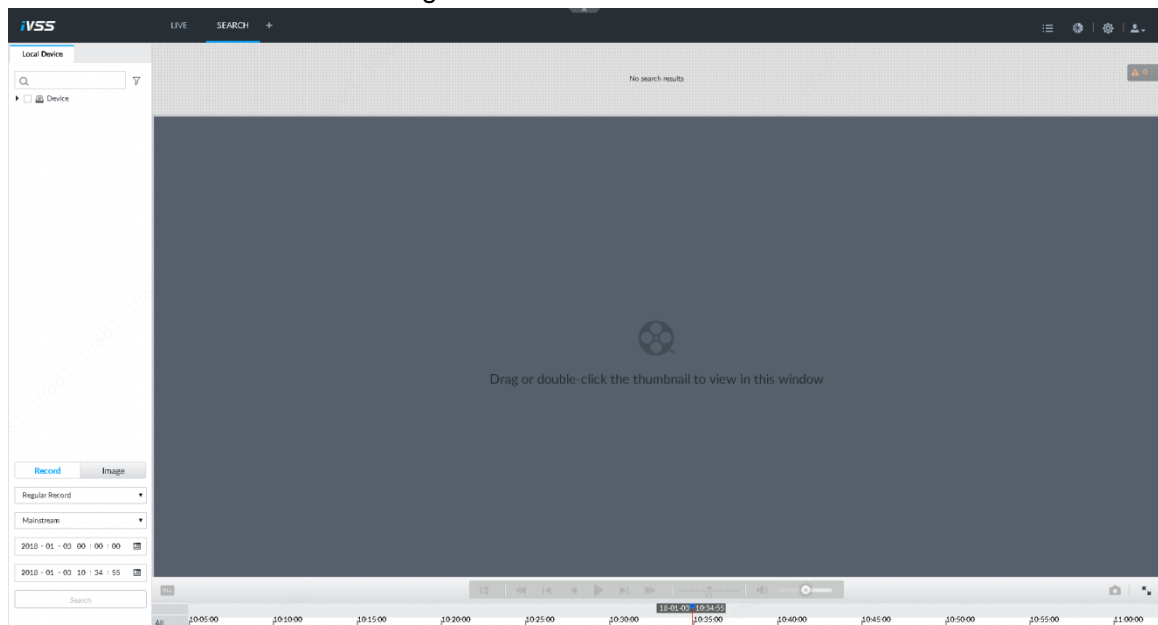



Figure 5-29

Step 2 Select a remote device, and then click Record tab.

Step 3 Set record type and record search time.

- Mode 1: Click the date or time on the time column, change time or date value.

- Mode 2: Click the date or time on the time column, use the mouse middle button to adjust time or date value.
- Mode 3: Click , set date or time on the calendar, and then click OK button. See Figure 5-30.

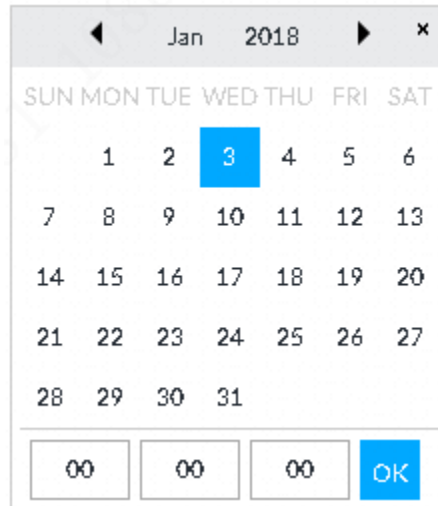





Figure 5-30

Step 4 Click Search.

Device displays search results. The record thumbnail is at the top of the remote device, the time bar displays the record period (green color means there is a record). See Figure 5-31.

 **Note**

- The selected remote device is on the left pane, click a remote device, the record file thumbnail is on the right pane.
- Click  or  to move thumbnail list or hide/display the thumbnail.
- Move the cursor to the thumbnail, you can view the corresponding record belonging remote device name, record start time, end time.
- Move the cursor to the thumbnail list, the interface displays . Click the icon, it is to hide the thumbnail list. If the thumbnail list is hidden, click  to display the thumbnail list.

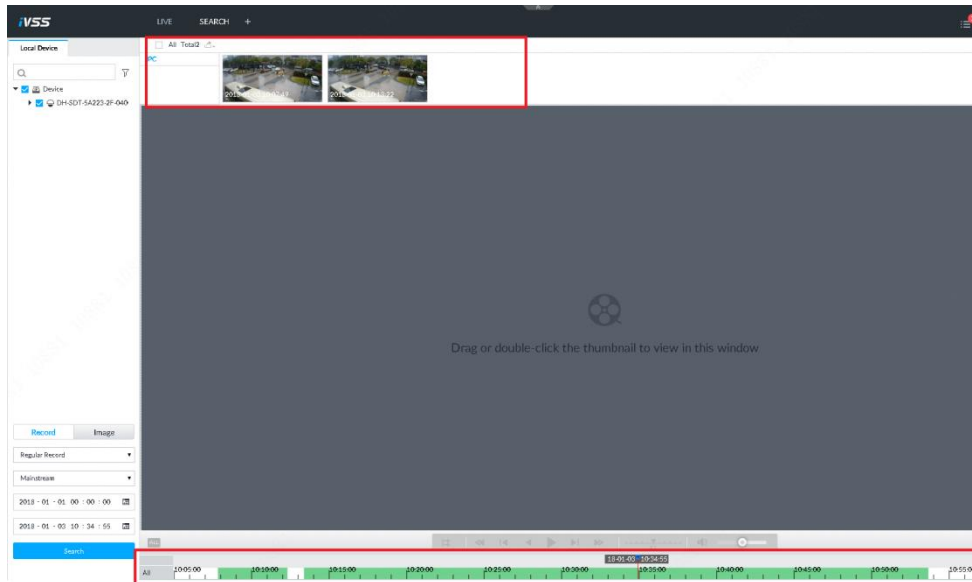

Figure 5-31

Step 5 Drag the thumbnail to the playback window or double click the thumbnail.  
Device begins playing the record. See Figure 5-32.

**Note**

- The playback window amount depends on the thumbnail amount or you can drag to set. System max supports 16 windows. System automatically adjusts each window size according to the playback file original rate.
- The thumbnail with , it means system is playing record file of current thumbnail.

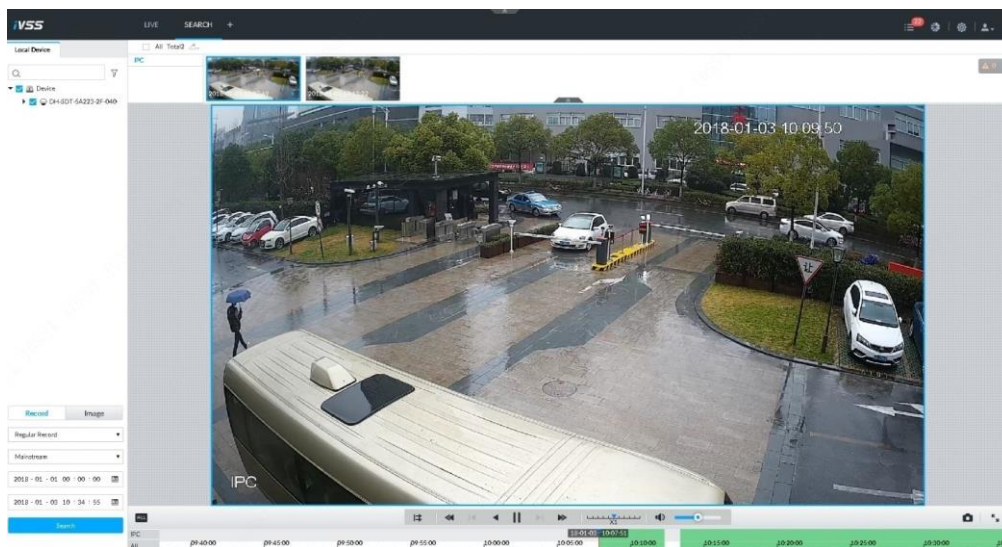

















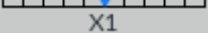

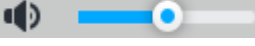









Figure 5-32

Name	Function
	Click to synchronize playback mode. You can use the playback control icon to control several windows such as to fast forward/backward at the same time. Click  to cancel synchronization operation.

Name	Function
	<p>Playback several record files at the same time. Click the icon to switch to record synchronization mode. It is to set other windows are playing the video file of the same time.</p> <p>Click  to cancel time sychronization.</p> <p> <b>Note</b></p> <p>Click , system enables synchronization operation function. If you want to cancel synchronization, click .</p>
	<p>Click to playback video file at slow speed. The slow speed includes <math>\times 1/2</math>, <math>\times 1/4</math>, <math>\times 1/8</math>, <math>\times 1/16</math>. Click the icon once, the playback speed degrades one level.</p>
	<p>Click to switch to frame by frame backward playback.  <b>Note</b> It is only valid in pause mode.</p>
	<p>Click to play backward. Now the icon becomes . Click  to stop backward play.</p>
	<p>Click to stop playback. Now the icon becomes . Click  to playback video again.</p>
	<p>Click to switch to frame by frame playback.  <b>Note</b> It is only valid in pause mode.</p>
	<p>Click to playback at fast speed. The fast speed includes <math>\times 1</math>, <math>\times 2</math>, <math>\times 4</math>, <math>\times 8</math>, <math>\times 16</math>. Click the icon once, the playback speed degrades one level.</p>
	<p>It is to display playback speed. Drag the  to the left or right, it is to playback at fast forward or fast backward.</p>
	<p>Click to snapshot an image.</p>
	<p>Control volume.</p> <ul style="list-style-type: none"> <li>• Drag  to set volume level.</li> <li>• Click to mute. Now the icon becomes . Click  to cancel mute.</li> </ul>
	<p>Click to playback at full screen.</p>

Name	Function
	<p>Time bar. It is to display record type and record file period.</p> <ul style="list-style-type: none"> <li>There are two record file bar on the time bar. The top bar is to display record time of selected window. The bottom bar is to display record time of all selected remote devices.</li> <li>The time bar adopts color to category record type. Green=Regular record. Red=Alarm record. Blank=No record.</li> <li> Time scale is to display record file date and time. System automatically adjusts time scale according to the record playback process.</li> <li>On the time bar, you can : <ul style="list-style-type: none"> <li>Click the time bar and drag the mouse to adjust the time unit.</li> <li>Press the time bar and then drag to the left or right. It is to move the time bar to view the hidden record time.</li> <li>Drag time scale, it is to adjust record file playback start time.</li> <li>Click or drag the time scale to position where there is a record, system starts playing from the selected time.</li> <li>Click or drag the time scale to position where there is no record, system stops playing record.</li> </ul> </li> </ul>
	<p>Right click mouse on the playback window, you can view the shortcut menu.</p> <ul style="list-style-type: none"> <li>Digital zoom: It is to zoom in a specified zone and view the details. Refer to chapter 5.2.1.3.3 digital zoom for detailed information.</li> <li>Original Scale: it is to set video window scale. <ul style="list-style-type: none"> <li>Auto: System automatically adjusts video window scale according to the video resolution.</li> <li>Exit: System automatically adjusts video window scale according to the remote device amount and the free space on the playback pane.</li> </ul> </li> <li>Audio: Set audio output.</li> </ul>
	<p>Move mouse to the playback window, system pops up task column. Click the icon to close the playback window.</p>

### 5.3.2 Clip Footages

It is to clip footages from a record file and save to PC or the USB storage device.

#### Note

Connect USB device to the system if you are on the local menu to operate.

#### Steps

Step 1 On the Live interface, click  and then select Search.

Enter Search interface.

Step 2 Refer to chapter 5.3.1 Playback record file to play video file.

Enter playback record file interface. See Figure 5-33.

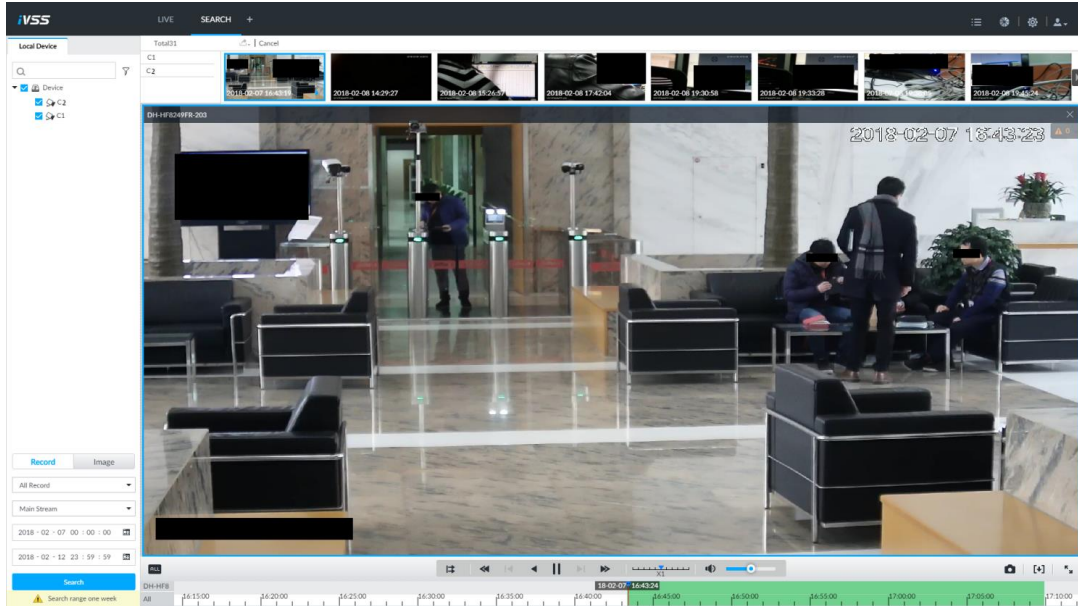

Figure 5-33

Step 3 Click .

System displays edit column on the time bar. See Figure 5-34.



Figure 5-34

Step 4 Press the record edit column (the blue column on Figure 5-34) and drag to the left or right, it is to select clip file start time and end time.

Step 5 Click Save now.

System pops up Save interface. See Figure 5-35.

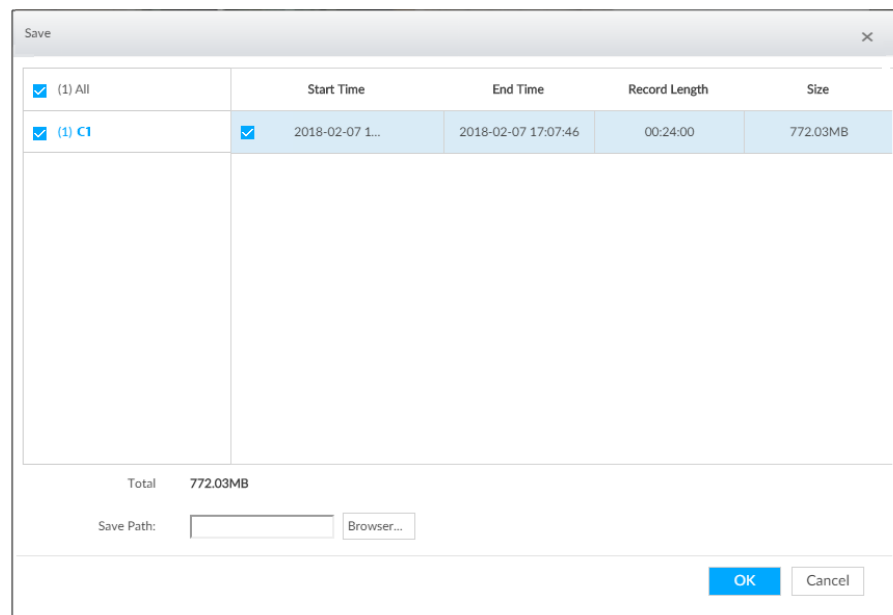

Figure 5-35



Step 6 Click browser to select save path.

Step 7 Click OK.

It is to save the select footages to the local PC or the USB device.

### 5.3.3 Playback Image

It is to search and playback image according to remote device, record type, and record time.

#### Steps

Step 1 On the Live interface, click  and then select Search.

Enter Search interface.

Step 2 Select a remote device, and then click Image.

Enter image playback interface. See Figure 5-36.

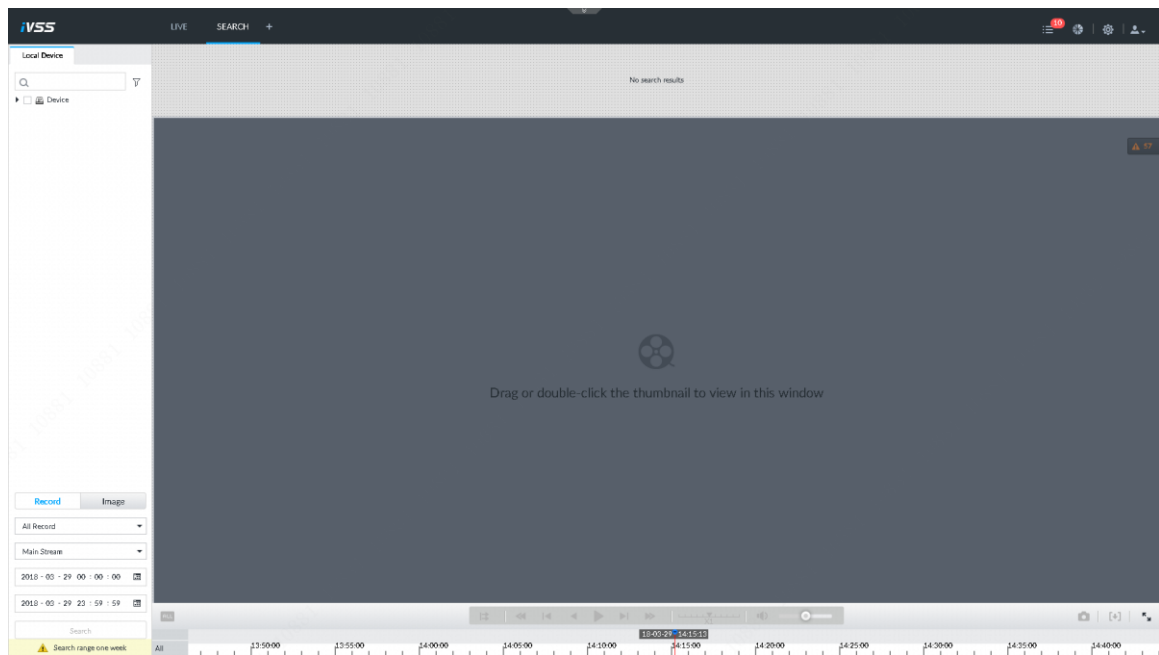



Figure 5-36

Step 3 Set search time.

- Mode 1: Click the date or time on the time column, change time or date value.
- Mode 2: Click the date or time on the time column, use the mouse middle button to adjust time or date value.
- Mode 3: Click , set date or time on the calendar, click OK button. See Figure 5-37.

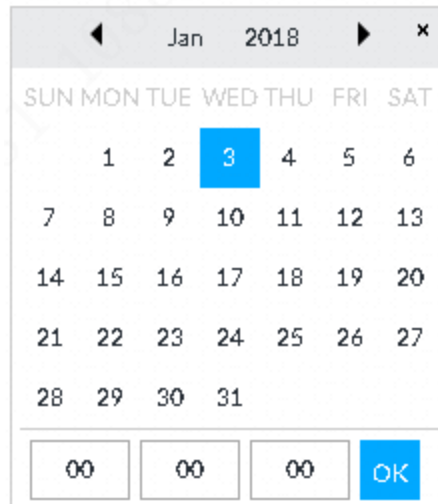

Figure 5-37

Step 4 Click Search.

System displays searched image thumbnail. See Figure 5-38.

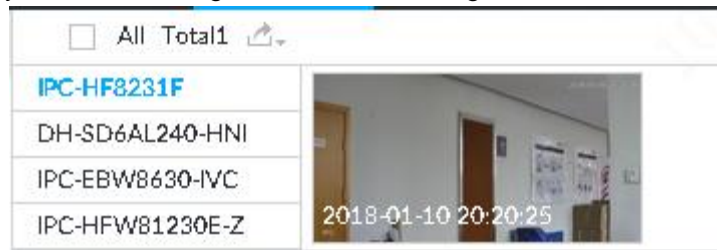





Figure 5-38

- The selected remote device is on the left pane, click a remote device, the image thumbnail is on the right pane.
- Click  or  to move thumbnail list or hide/display the thumbnail.
- Click the thumbnail to select the image.
- Move the cursor to the thumbnail list, the interface displays . Click the icon, it is to hide the thumbnail list. If the thumbnail list is hidden, click  to display the thumbnail list.

Step 5 Drag the thumbnail to the playback window or double click the thumbnail.

Device begins playing the record. See Figure 5-39.

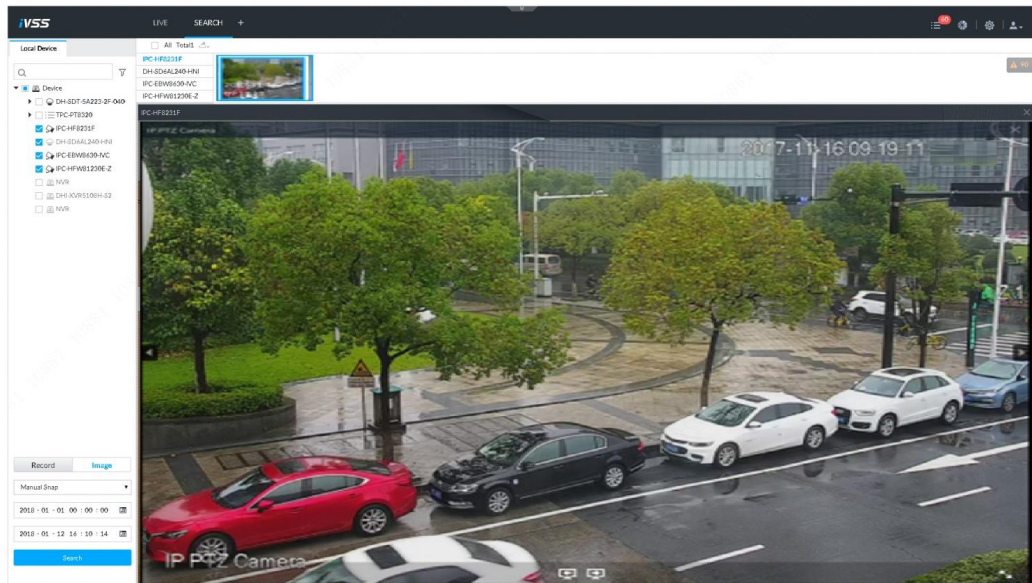

Figure 5-39



**Note**

Move the cursor to the playback window, you can see the following icons.

Icon	Function
	Click to switch to the previous image or the next image.
	Switch image. <ul style="list-style-type: none"> <li>● When play one image, click to go to the previous image or the next image.</li> <li>● When play several images at the same time, click to go to the previous group or the next group.</li> </ul>
	Click to play at full screen. Click again to cancel full screen.

### 5.3.4 Export File

It is to export record file, image to the USB device to storage.



**Note**

- The default record file mode is .dav and the image file mode is .jpg.
- Connect USB device to the system if you are on the local menu to operate.

### Steps

Step 1 On the Live interface, click and then select Search.

Enter Search interface. See Figure 5-40

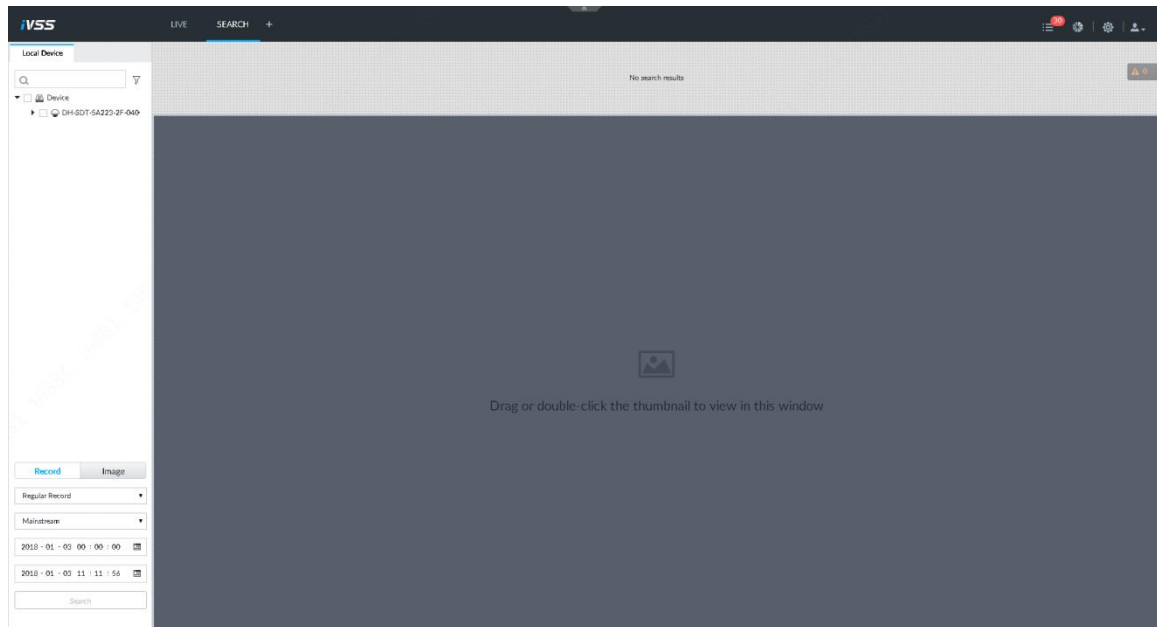

Figure 5-40

Step 2 Search record file or image.

1. Click Record or Image tab.
2. Select a remote device and then set search criteria.
3. Click Search.

Device displays searched record files or image. See Figure 5-40 (video record file thumbnail) or Figure 5-42 (image thumbnail).

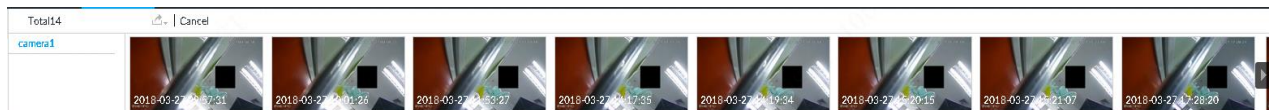

Figure 5-41



Figure 5-42

Step 3 Select the record file or image you want to export.

- Move the cursor to the thumbnail and then click  to select the thumbnail.  means checked.
- Click Select again, it is to cancel all record files or images.

Step 4 Select file saved path.

1. Click and then select export record or export image.

**Note**

The following steps are to export video file. Please refer to the actual interface for detailed information.

2. Click OK.

Enter saving interface. See Figure 5-43.

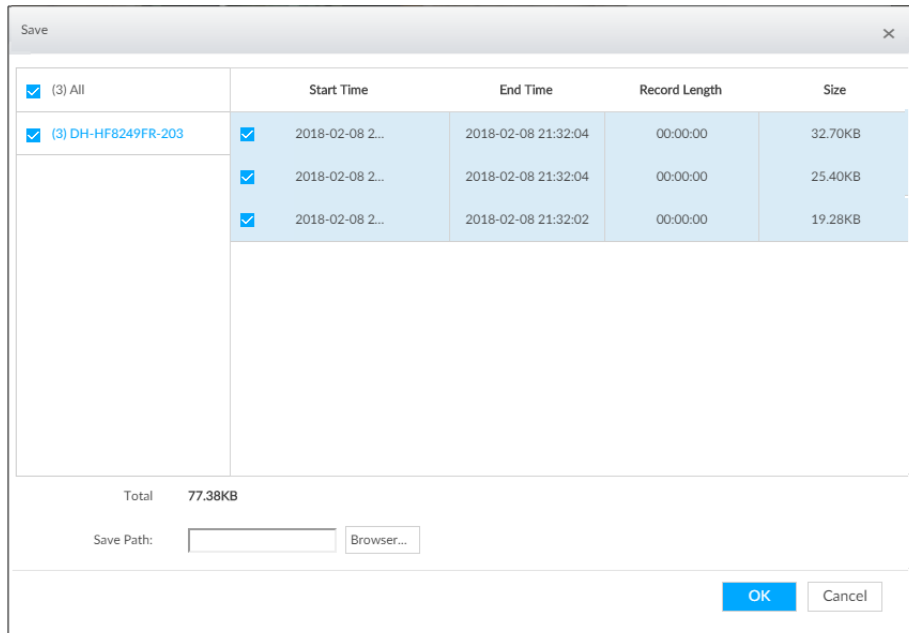

Figure 5-43

3. Click Browse, it is to set storage path.

**Note**

For local menu operation, after you set storage path, the save interface displays format button. Click format button to clear all data on the USB storage device.

4. Click OK button.  
Device goes back to Save interface.

Step 5 Click OK button.

Device begins exporting files and display download interface. See Figure 5-44.

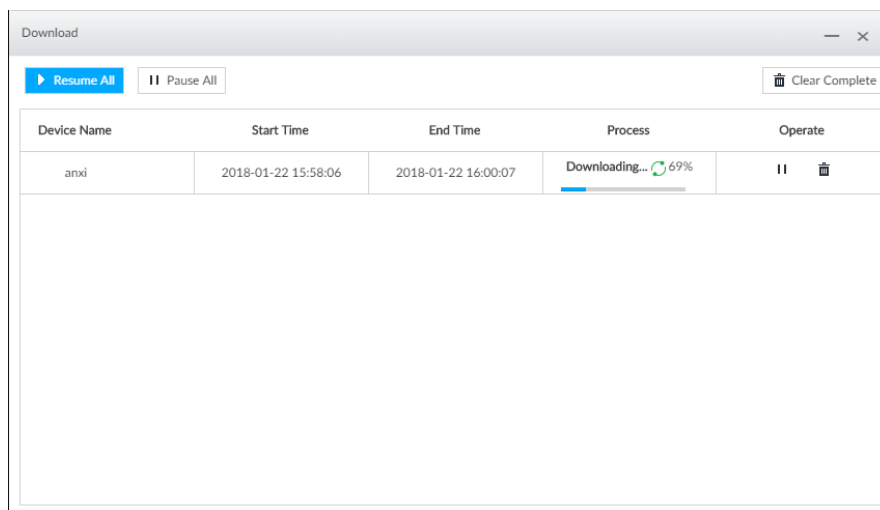

Figure 5-44

- Click Pause all to pause all download tasks. Click Start all to resume download tasks.
- Click Clear completed columns to delete all downloaded tasks.
- Click the of the corresponding task, it is to pause download task. Click to resume

download.

- Click the of the corresponding task, it is to delete download task.

## 5.4 Alarm List

Click to display alarm list. See Figure 5-45. It is to view alarm device name, alarm time and alarm type.

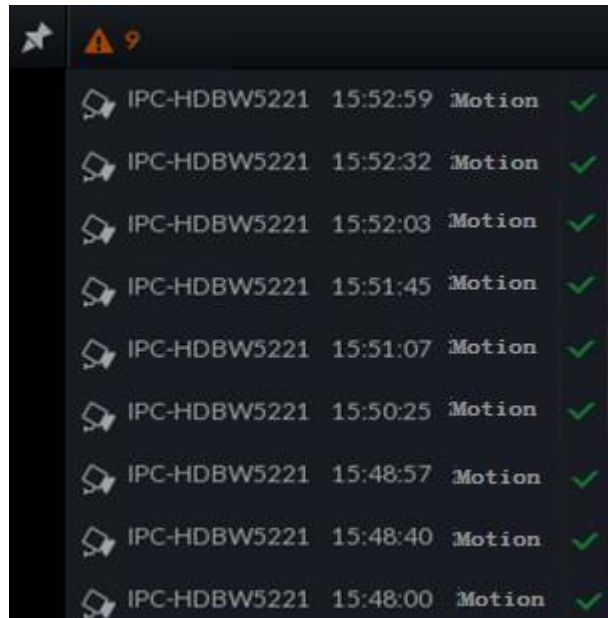

Figure 5-45

- Number “9” is the alarm event to be processed. The value changes according to alarm amount.
- Click to lock alarm list. The alarm list is open and cannot hide. Click the icon again to cancel lock function. Move the mouse to other position, the alarm list displays for a period of time and then auto hide.
- Click to confirm alarm event. The confirmed event will be removed from the alarm list.
- Click the alarm event on the alarm list, the device displays the 20 seconds video before and after the alarm event occurred.
  - ✧ Click to pause play. Now the icon becomes . Click again to continue play.
  - ✧ Click OK and then close, confirm the alarm event and then exit the interface.

## 5.5 Display

It is to enable connected displayer or lock the screen.

### 5.5.1 Multiple-Screen Control

Device can connect to multiple-displayers at the same time. You can select a displayer you want to use.



#### Note





- The multiple-screen control function is for local menu only.
- Enter display output interface, you can select a displayer to enable or set its resolution. Refer to chapter 6.8.3 Display for detailed information.

- The interface may vary since the connected display amount is not the same.

Click , device pops up Display interface. See Figure 5-46.

- SN 1~3 represent displays connected to HDMI 1~HDMI 3. The main display refers to the device connected to VGA and HDMI 1 port (The HDMI/VGA port on Figure 5-47.). The displays connected with the HDMI 2 and HDMI 3 is the sub screen. The main display and the sub display output interface are not the same and the supported functions are different. Refer to the following table for detailed information.
- VGA and HDMI 1 are output the same video source. HDMI 1 and HDMI 2 are output different video source.



-  means connected and enabled display.  means connected but not enabled display.
- Click  or  to disable or enable display. Device adopts main display by default and the main display cannot be disabled.

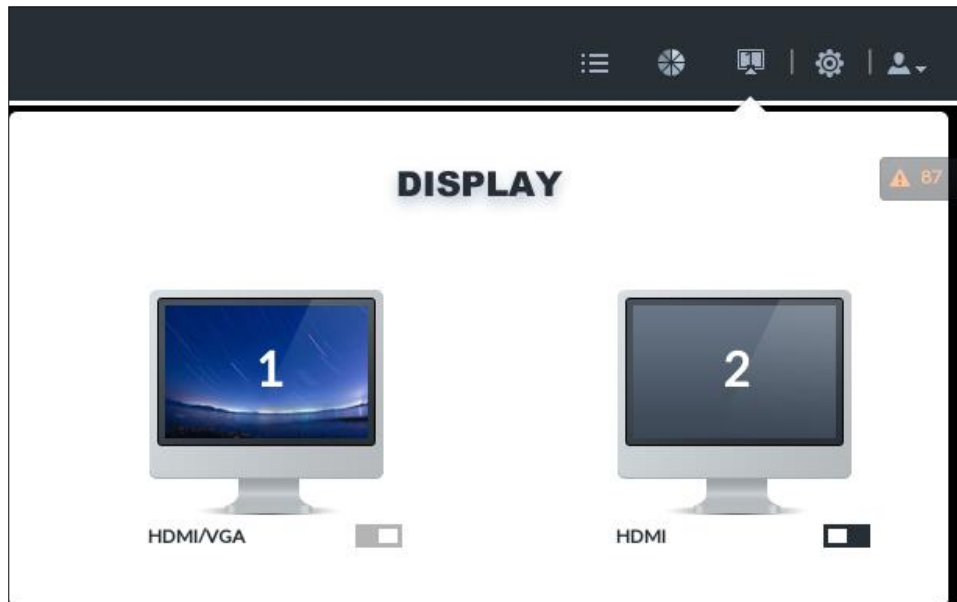



Figure 5-46

Function		Main screen	Sub screen
Operation	User operation (Login, log out, modify password, lock ,etc.)	Support	Support
	Preview and surveillance	Support	Support
	Playback and control	Support	Support
	Confirm alarm	Support	N/A
	File management	Support	Support
	AI	Support	Support
	Multiple-screen control	Support	N/A

Function		Main screen	Sub screen
	System message	Support	Support
	Background task	Support	Support
	Operation and maintenance management	Support	Support
	Device operation(Reboot, shut down)	Support	N/A
System configuration	Account, network, event, storage, security strategy, system management.	Support	N/A

### 5.5.2 Lock Displayer

Click  and then select Lock to lock the displayer. The displayer stops at current video and cannot operate other function. If you want to unlock the screen, click any position on the displayer, input password or user other account to login. See Figure 5-47.

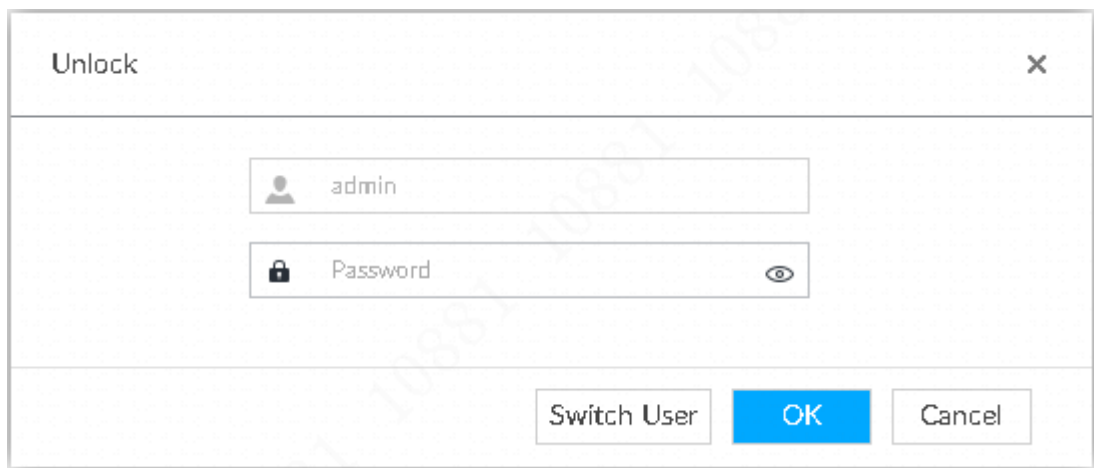

Figure 5-47

## 5.6 File

It is to create the human face library to save human face image so that the intelligent detection function can trigger the human face library to detect such as human face comparison, human face search ,etc.

### 5.6.1 Configuring Human Face Database

After setting human face library, the intelligent detection function can trigger the human face library to compare human face, search human face ,etc. The human face library setting includes create human face library, add human face image and create human face module.

#### 5.6.1.1 Create human face library

It is to create human face library and enable/disable human face image (add the human face image to the newly created library.)

#### Steps



Step 1 On Live interface, click , from File to Face database.

Enter face database interface. See Figure 5-48.

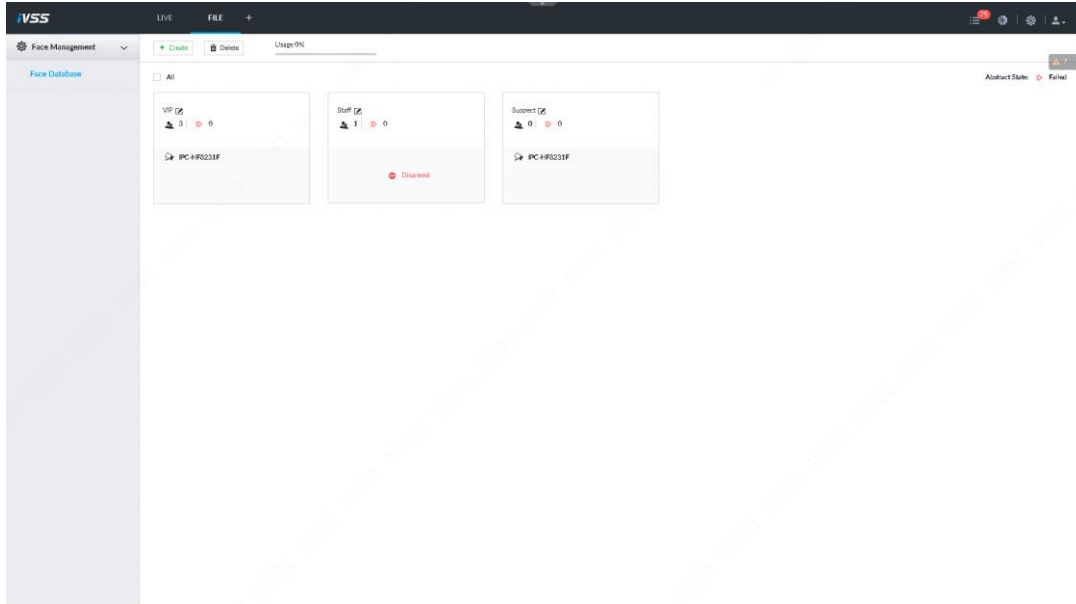

Figure 5-48

Step 2 Click .

Enter create database interface. See Figure 5-49.

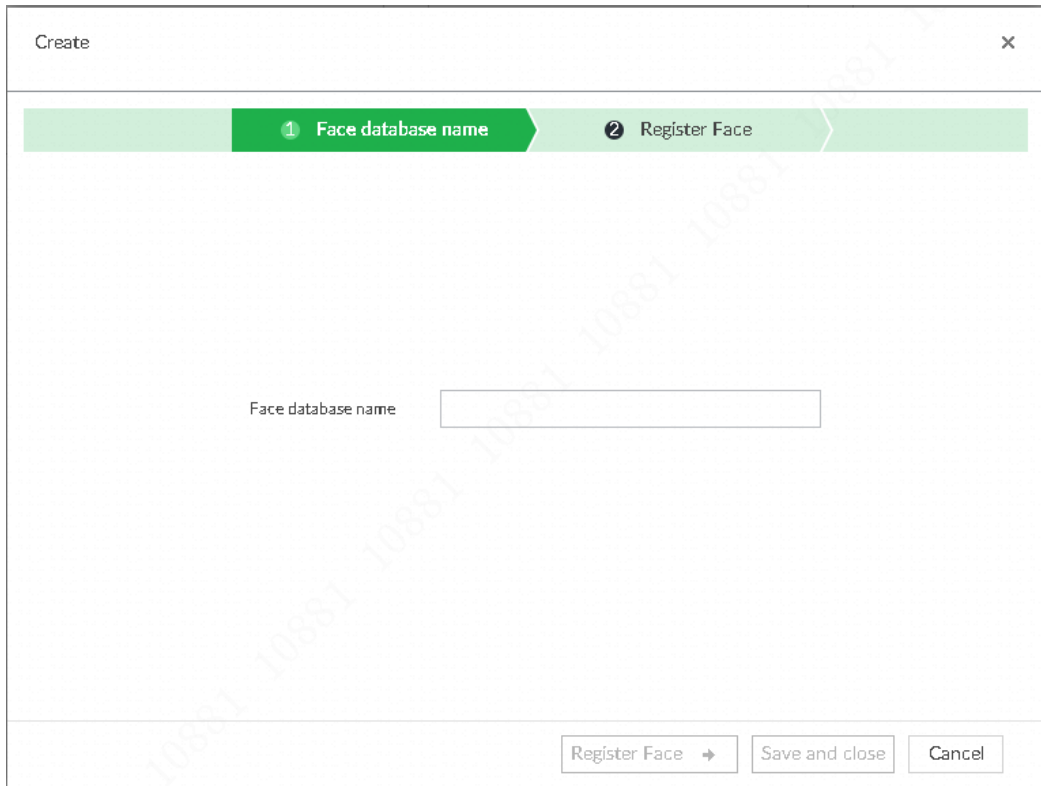
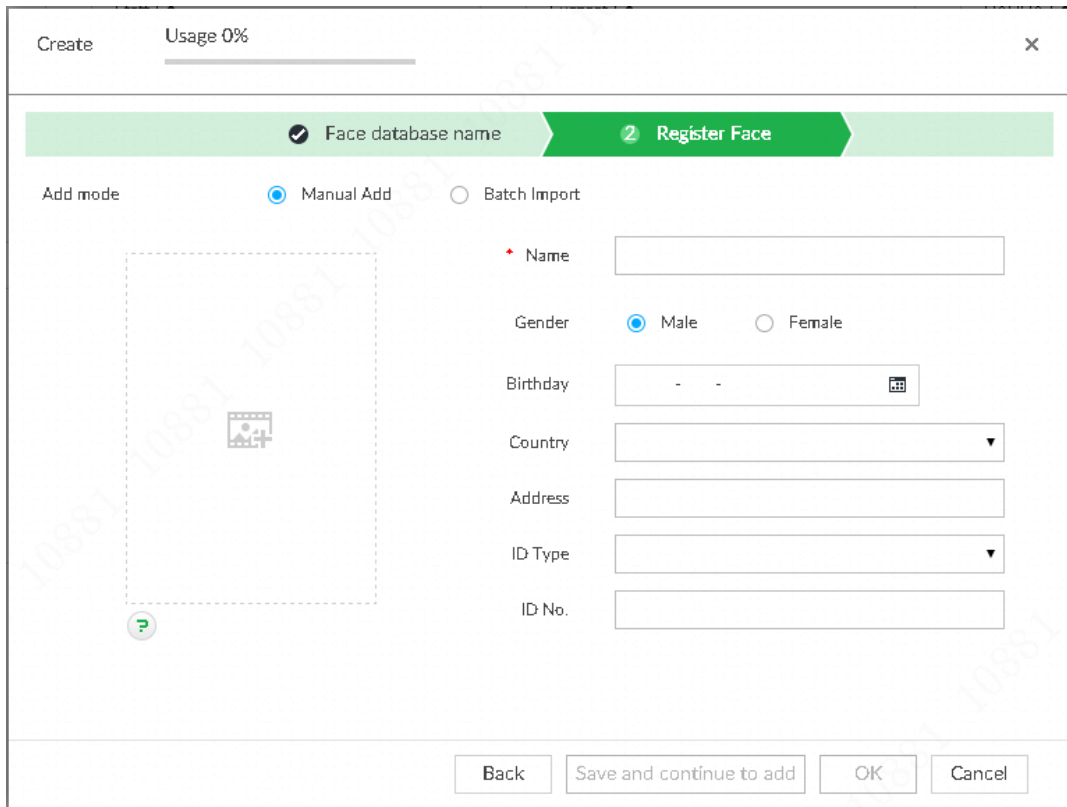

Figure 5-49

Step 3 Set Human face database name.

Step 4 Click Register human face or Save and then close.

- Click Register human face, and then add human face on the newly created human database. See Figure 5-50. Refer to chapter 5.6.1.2 Add human face image for detailed information.



Create Usage 0%

Face database name 2 Register Face

Add mode  Manual Add  Batch Import

Name

Gender  Male  Female

Birthday

Country

Address

ID Type

ID No.

Back Save and continue to add OK Cancel

Figure 5-50

- Click Save and then close to create a human face database of no data. After create human face database, you can go to the human face database management interface to view the newly created human face library information. See Figure 5-51.

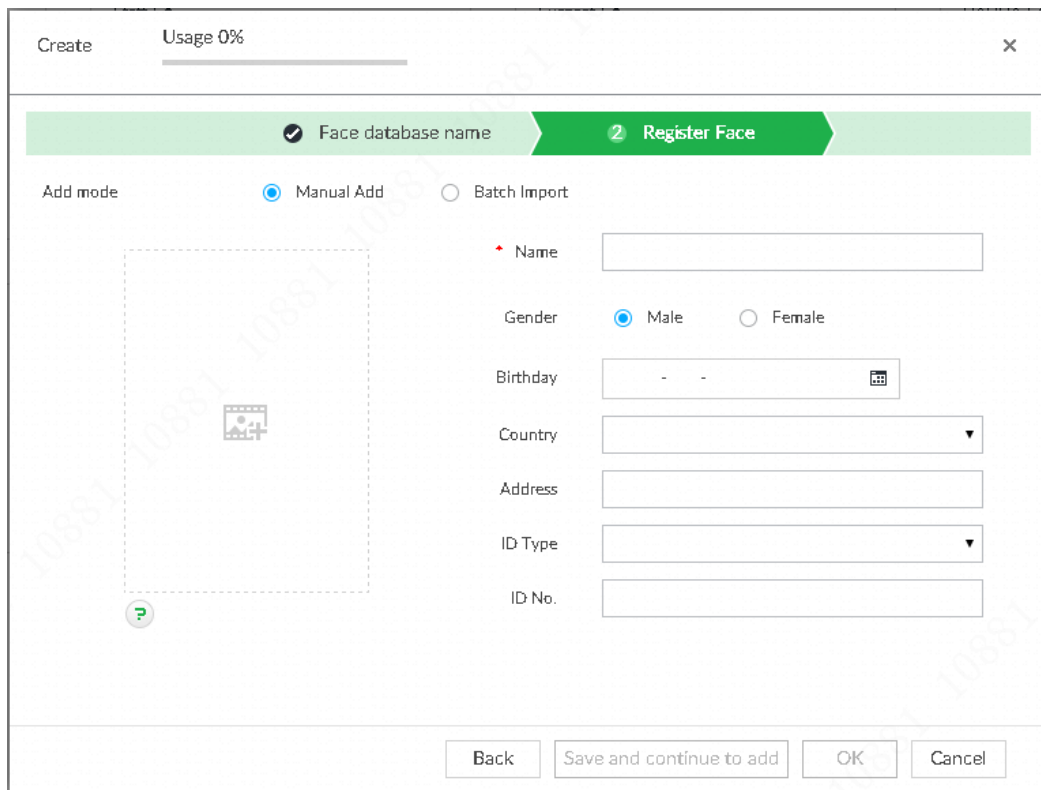

Figure 5-51

**Note**

- Click to change human face database name.
- 4 is to display human face image of current database.
- 0 is to display human face modeling that failed. Refer to chapter 5.6.1.3 Human Face Modeling for detailed information.
- Disarmed means current human face database has not connected to the corresponding channel to compare human face. Refer to chapter 6.4.2.3.4 Human face comparison for detailed information. After arm, the interface can displayed the connected channel name of the remote device. See Figure 5-52.

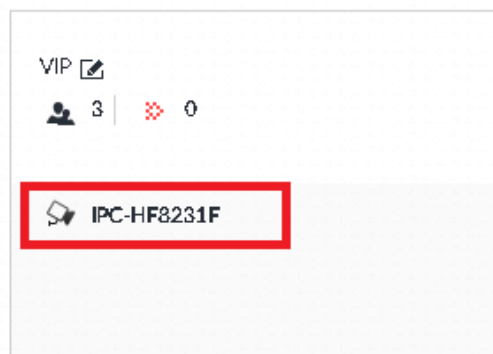

Figure 5-52

### 5.6.1.2 Add human face image

It is to add the human face image on the created human face database. It supports manual add and batch import.

#### Note

The added human face image shall meet the following criteria:

- The image format is .jpg.
- The image size shall be less than or equal to 256KB.
- The resolution ranges from 200×200~6000×5000.

### Preparations

- Before the operation, make sure you have created the human face database. Refer to chapter 5.6.1.1 Creating human face database.
- The human face image is on the USB device and you have connected the USB storage device to the device.

#### Note

The operation is for local menu only.

#### 5.6.1.2.1 Manual add

It is to add human face image one by one. If the registered human face image amount is small, you can use manual add mode.

### Steps

Step 1 On Live interface, click , from File to Face database.

Enter human face database.

Step 2 Double click human face database.

Enter human face database interface. See Figure 5-53.

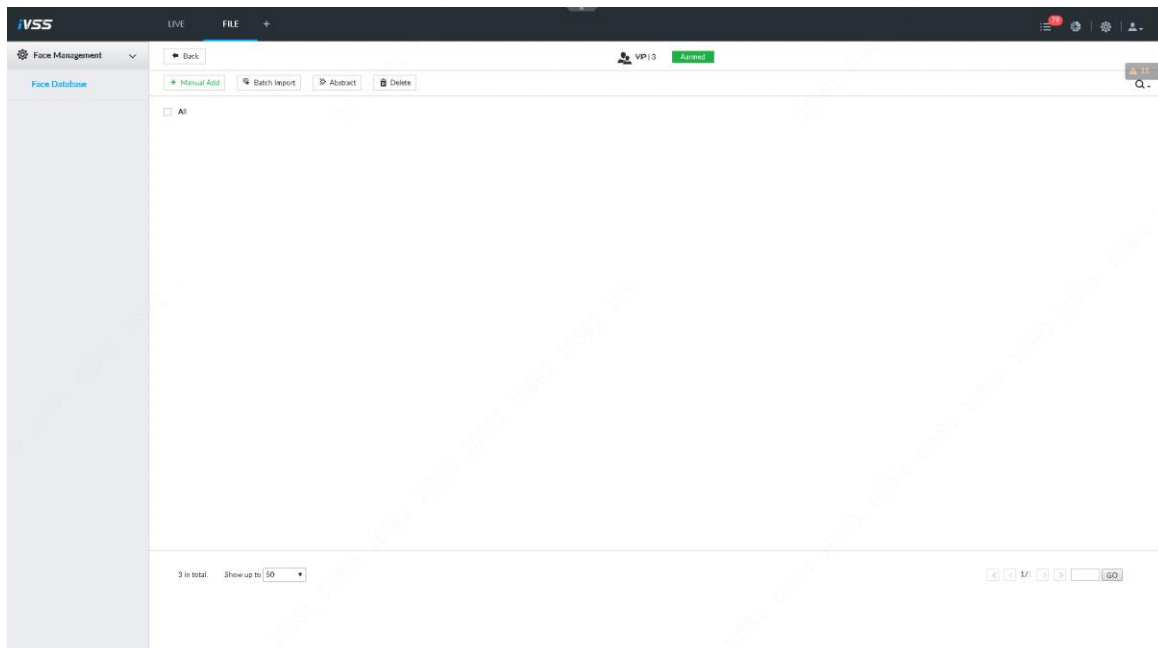



Figure 5-53

Step 3 Click manual add.

Enter Face register interface. See Figure 5-54.

Figure 5-54

Step 4 Click , import human face image.

After import, the image pane on the left side can display human face image. See Figure 5-55. Click Change image to replace current human face image.

Click  to adjust human face pane size.



Figure 5-55

Step 5 Input human face image information according to the actual situation.

Step 6 The human face registration is complete.

- Click Save and add more, it is to save current human face image information and add

another human face image.

- Click OK to save current human face image information and complete registration.

After add the image, at the bottom left corner of the human face image, there is an icon . It means device is creating module. See Figure 5-56. Refer to 5.6.1.3 Human face modeling for detailed information.

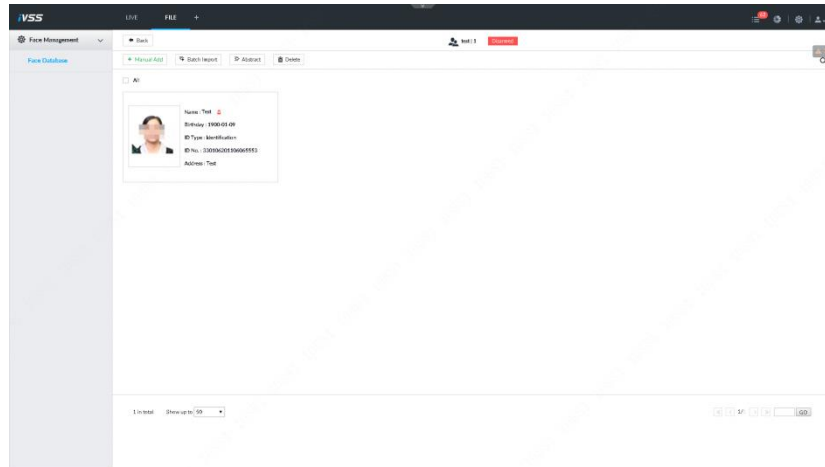

Figure 5-56

#### 5.6.1.2.2 Batch Import

Batch import is to import multiple human face image at the same time. If you want to register a large amount human face image, please use batch import function.

Before you batch import human face image, please follow

the “Name#SGender#B#Birthday#CCountry#PProvince#T ID type#M ID number#A Address.jpg” (such as “Tim#S1#B20000101#NCN#PZheJiang#T1#M0000#AAddress”) to give human face image a name.



**Note**

The name is the compulsive item. The rest items are optional.

Naming Rule	Note
Name	Input corresponding name
Gender	1=Male, 2=Female
Birthday	Input number. The format is yyymmdd such as 20171123.
Country	Input the country abbreviation name. Refer to the following sheet for detailed information.
Province	Input province name.
ID type	Input number. “1”=ID card, “2”=Military officer certificate, “3”=Passport
Address	Input detailed address.

Country	Abbreviation	Country	Abbreviation	Country	Abbreviation
China	CN	Cambodia	KH	India	IN
Malaysia	MY	Maldives	MV	Mongolia	MN
Philippines	PH	Qatar	QA	Saudi Arabia	SA
Singapore	SG	Korean	KR	Sri Lanka	LK

Country	Abbreviation	Country	Abbreviation	Country	Abbreviation
Turkey	TR	Thailand	TH	United Arab Emirates	AE
Vietnam	VN	Austria	AT	Belarus	BY
Belgium	BE	Bulgarian	BG	Denmark	DK
Estonia	EE	Finland	FI	France	FR
Greek	DE	Hungary	HU	Ireland	IE
Italy	IT	Lithuania	LT	Luxembourg	LU
Netherland	NL	Norway	NO	Poland	PL
Portugal	PT	Romania	RO	Russian	RU
Serbia	CS	Spain	ES	Sweden	SE
Ukraine	UA	England	UK	Argentina	AR
Bahamas	BS	Belize	BZ	Brazil	BR
Canada	CA	Chile	CL	Columbia	CO
Mexico	MX	Panama	PA	Peru	PE
American	US	Venezuela	VE	British Virgin Islands	VG
Egypt	EG	Morocco	MA	Nigeria	NG
Seychelles	SC	South Africa	ZA	Tunisia	TN
Australia	AU	New Zealand	NZ	-	-

## Steps

- Step 1 On Live interface, click , from File to Face database.  
Enter human face database.
- Step 2 Double click human face database.  
Enter human face database interface.
- Step 3 Click batch add.  
Enter batch add interface. See Figure 5-57.

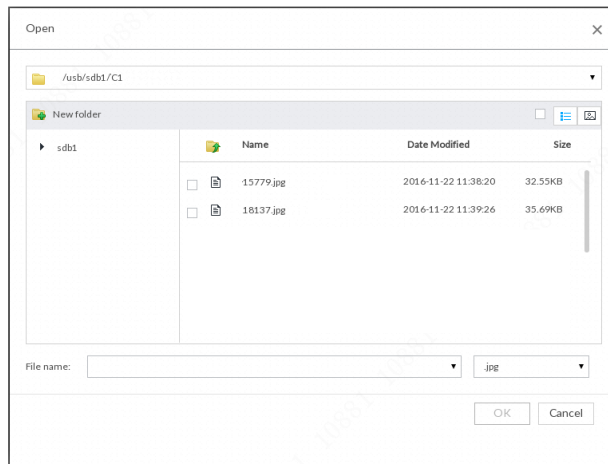

Figure 5-57

- Step 4 Click .

Enter Open interface. See Figure 5-58.

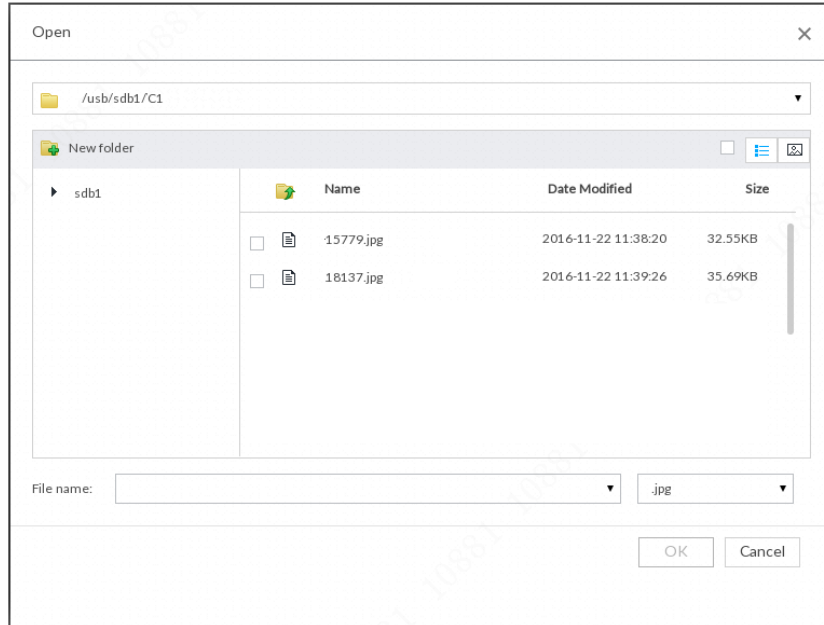



Figure 5-58

Step 5 After selected several human face images, click OK.

After add the image, at the bottom left corner of the human face image, there is an icon . See Figure 5-59. It means device is creating module. Refer to chapter 5.6.1.3 Human face modeling for detailed information.

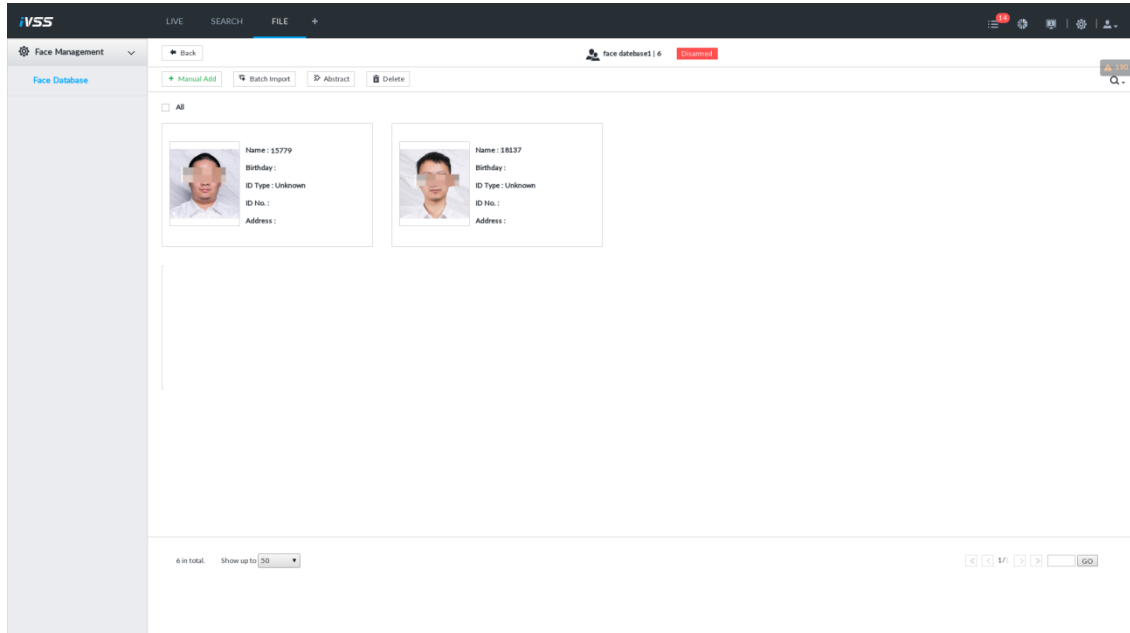

Figure 5-59

### 5.6.1.3 Human face modeling

The human face modeling is to save the corresponding information of the human face image and import to the database and then create the human face features module. In this way, device can compare human face, and search human face.



### Note

- The larger the human face amount is, the longer the human face modeling time it takes. Please be patient.
- During the modeling creation process, some intelligent functions (such as human face comparison, search human face etc.) are null. These functions become normal after the modeling process is complete.

## Steps

Step 1 On Live interface, click , from File to Face database.

Enter human face database.

Step 2 Double click human face database.

Enter human face database interface.

Step 3 Select human face images and then click mold.

Device pops up the dialogue box. See Figure 5-60.

### Note

- Check all button, it is to select all human face images on current human face database.
- If there are too many human face images on the human face database, click  to set search criteria (such as name, gender, birthday, country, modeling status) to quickly find the human face images.

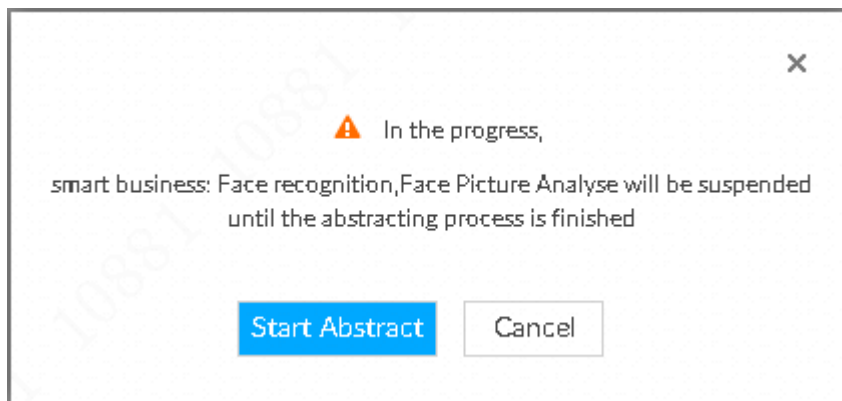



Figure 5-60

Step 4 Click Start.

Device begins creating module. See Figure 5-61.

- After successfully created the human face modeling, at the bottom left corner of the human face image, there is no icon .
- The modeling may become fail if the human face image is not clear or does not contain complete information. Now, at the bottom left corner of the human face image, there is an icon .

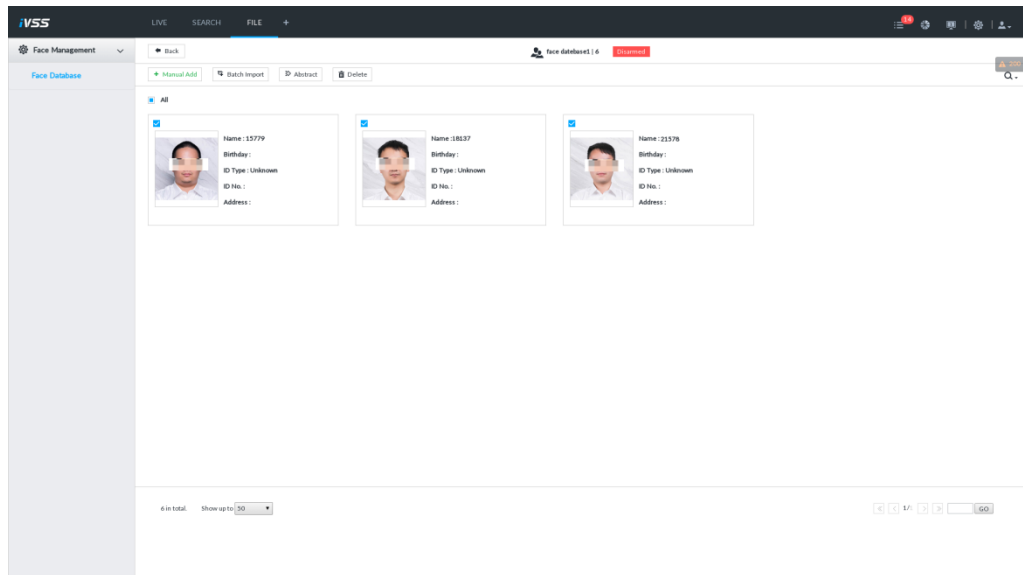

Figure 5-61

## 5.6.2 Managing Human Face Image

It is to add human face image to the human face database. It is to manage and maintain the human face images to guarantee information is correct.

### 5.6.2.1 Modify human face image



Enter human face database, move the cursor to the human face image and then click , enter edit human face interface. Change human face information and then click OK. See Figure 5-62.



Figure 5-62

### 5.6.2.2 Delete human face image



Enter human face database, delete the created human face image.

- Delete one by one: Move the cursor to the human face image and click the  at the top right

corner of the human face image to delete.

- Batch delete: Move the cursor to the human face image and then click the  at the top right corner of the several human face images. Click  to delete the selected human face image.
- Delete all: Check All box and then click  to delete all human face images.

### 5.6.3 Deleting Human Face Database

- Delete one by one: Move the cursor to the human face database and click the  at the top right corner of the human face database to delete.
- Batch delete: Move the cursor to the human face database and then click the  at the top right corner of the the human face database. Select several human face databases at the same time and then click  to delete.
- Delete all: Check All box and then click  to delete all human face database.

## 5.7 Intelligent Analytics

It is to upload human face image and then compare with the human face on the record file, device can filter the record file that its human face similarity has reached the threshold.



### Note

Device supports to upload the human face image on the human face database or the local human face (on the USB device or the PC). If you want to upload the image on the human face database, please make sure you have set human face database. Refer to chapter 5.6.1 Creating human face database for detailed information.

### Steps

- Step 1 On Live interface, click , from Analysis->Search Face.  
Enter search human face interface. See Figure 5-63.

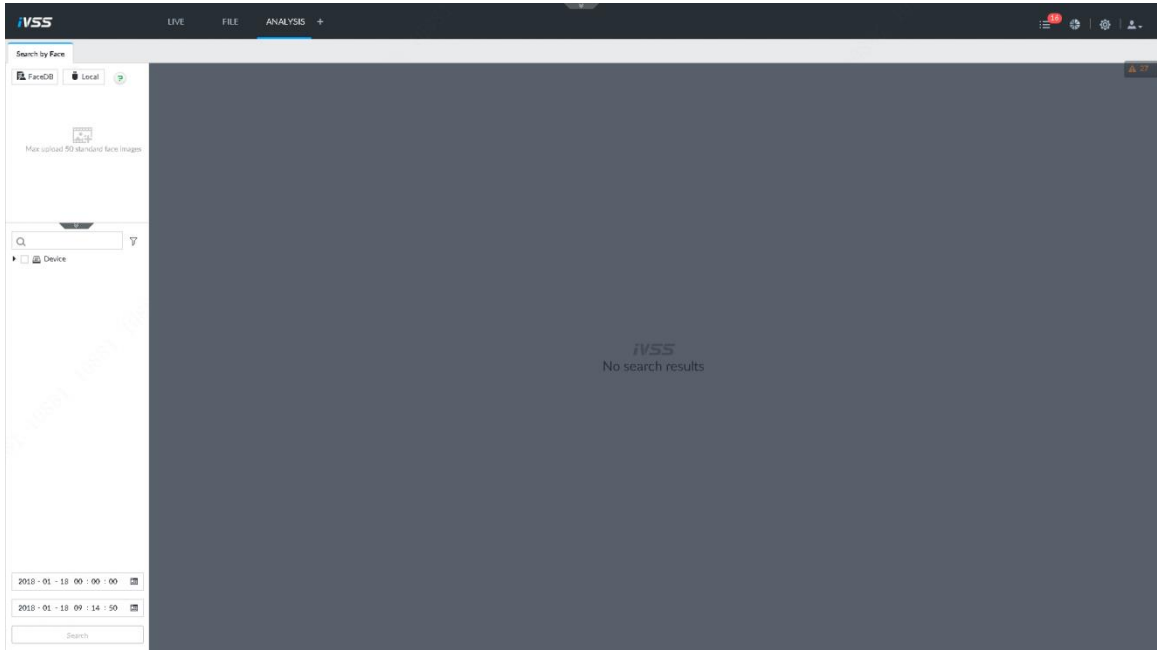

Figure 5-63

Step 2 Upload human face image.

**Note**

Device max supports 50 human face images.

- Human face image database: Upload the image from the human face image database to search corresponding human face.

1. Click Human face database image.

Enter Select from the human face database interface. See Figure 5-64.

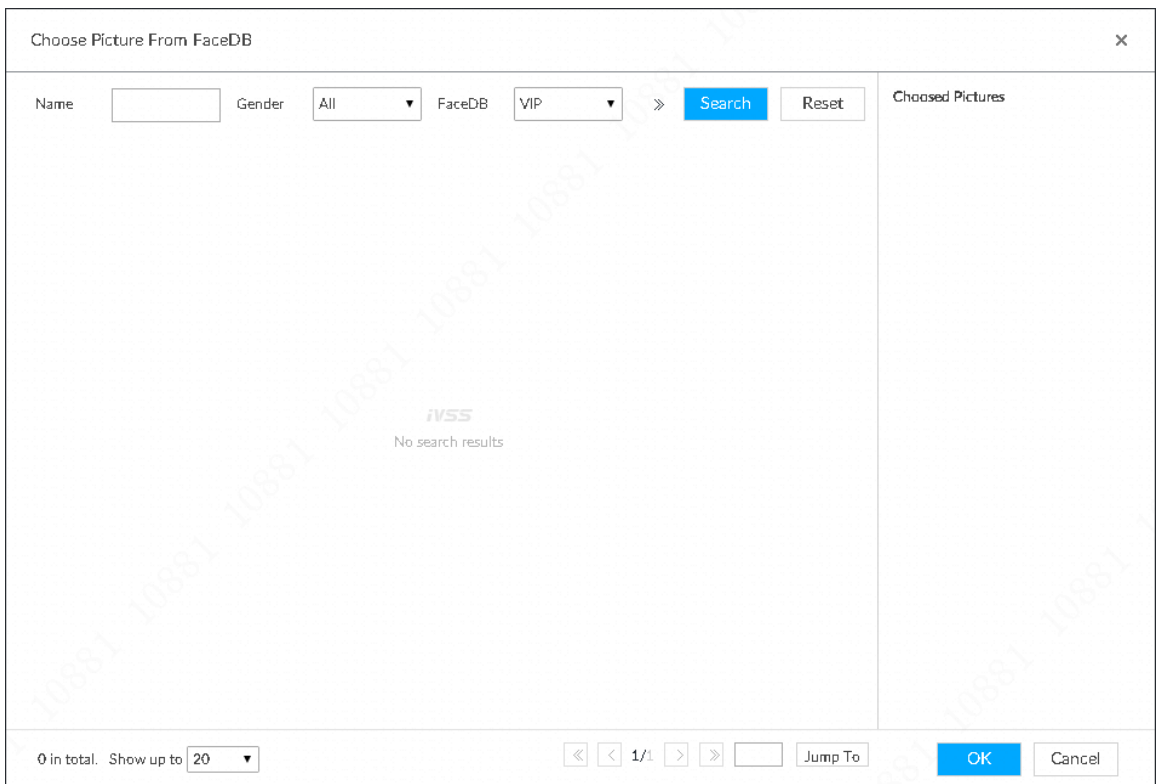

Figure 5-64

2. Select human face database and then set search criteria.

- ✧ If there are too many human face images on the database, please set name, gender to filter.
  - ✧ Click to set the search ID number.
  - ✧ Click Reset criteria to clear all search criteria settings.
3. Click Search.  
Device displays the searched human face images.
  4. Select human face image.  
The selected human face image is displayed on the checked features pane on the right side.
  5. Click OK to upload human face image.
- Upload local image.
    1. It is to storage human face image to the connected USB device.
- Note**  
This step is for local menu operation only.
2. Click Local image and then select human face image you want to upload.
- Note**  
You can select several human face images at the same time.
3. Click OK to upload human face image.

After upload the images, device displays the human face images on the top left corner. See Figure 5-65.

**Note**

Click Clear to delete all uploaded human face images.

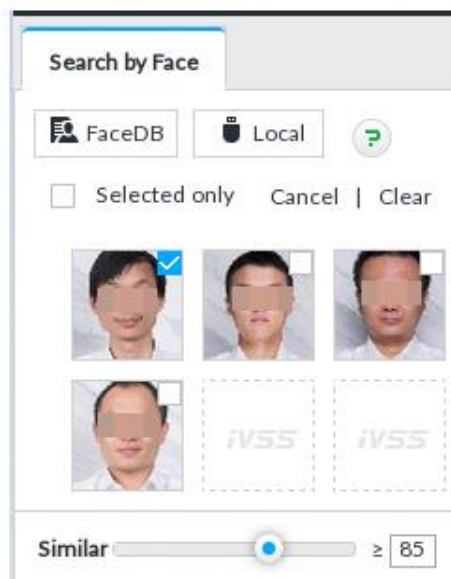

Figure 5-65

Step 3 Select human face image.

**Note**

Device max supports 10 human face images.

- Select Selected only, device displays checked human face images only.
- Click Cancel, cancel all checked human face images.

Step 4 Drag to set human face similarity.

Step 5 Select remote device on the device list and then set record file time period.

Step 6 Click Search.

Device begins searching record file and then display search results after the search is complete. See Figure 5-66.

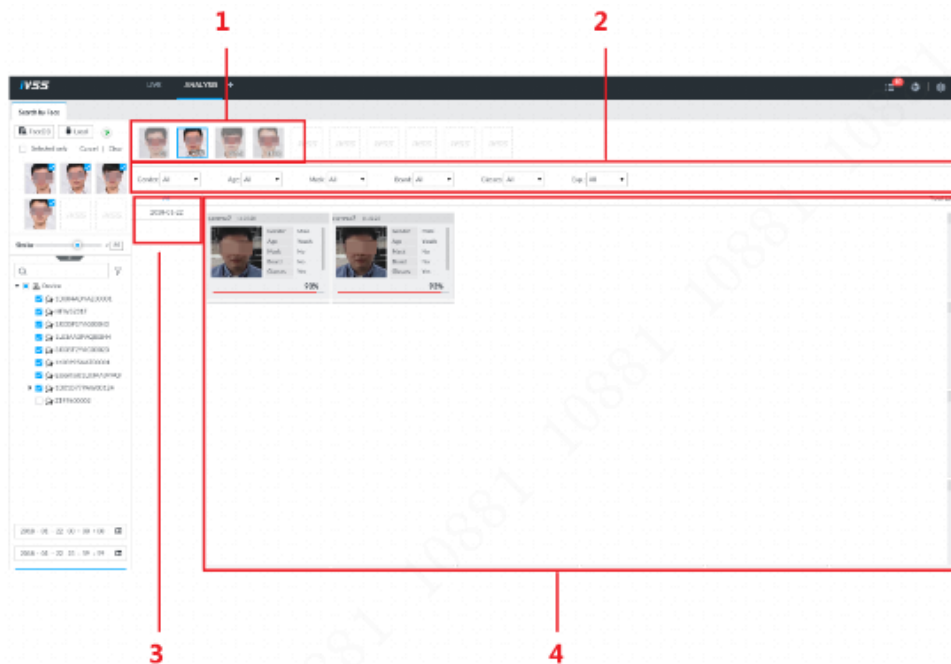



Figure 5-66

SN	Note
1	It is to display selected human face images. The number at the bottom right of the human face image is to display the searched record file amount.
2	It is to set filter criteria. It can quickly search the required record files according to the human face features.
3	It is to display searched calendar list. Click a date, you can view the record list on current date on the right pane.
4	It is to display the searched record file list. Double click a record file, it is to play the file (about 20 seconds.)

## 5.8 System Info

It is to view system information including system error, system alarm and system notification.

Click  to display system information list. See Figure 5-67.

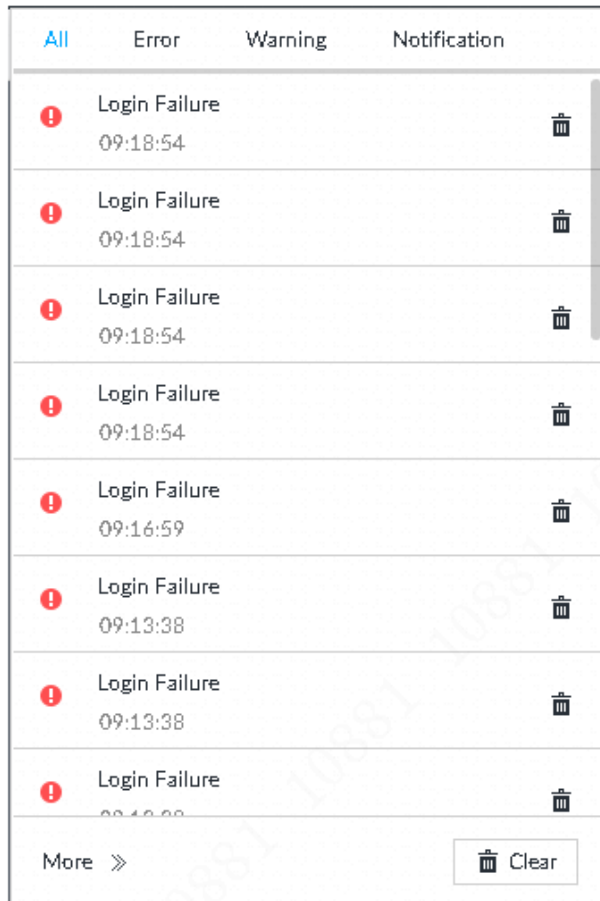



Figure 5-67

- Click All, error, warning, notification tab to view the corresponding system information list.
- Click  to clear the corresponding system information.
- Click Clear to clear system information on current tab.  
For example, click All tab and then click clear button to clear all system information. Click system error tab and then click Clear button to clear all system error information.

## 5.9 Background Task

It is to view background task running status.

Click , device displays background task list. See Figure 5-68. Click All/Running/Waiting to view the corresponding background task list.

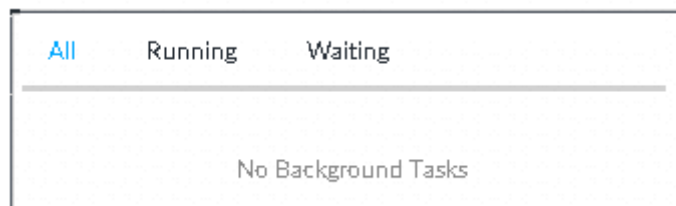

Figure 5-68

## 5.10 Operation and Maintenance Management

It is to operate and maintain the device working environment to guarantee proper operation.

### 5.10.1 Search Log

The logs record all kinds of system running information. Check the log periodically and fix the problems in time to guarantee system proper operation.

#### 5.10.1.1 System log

It is to search or export system log. It includes system running status log, file management log, hotspare log, hardware detect log and scheduled task log.

#### Steps

Step 1 On Live interface, click  from Maintain->Log->System.

Enter system log interface.

Step 2 Set search criteria such as system log level, type and date.



Click Reset to restore default search criteria.

Step 3 Click Search.

Device displays search results. See Figure 5-69.

Type	Level	Time	Summary
System_SyncSysTime	Notice	2018-03-29 09:05:14	Address:10.15.6.96 NewTime:2018-03-29 09:05:14 OldTime:2018-03-29 09:05:14
StartUp	Notice	2018-03-29 09:04:15	Flag:ExitPowerFail
About	Notice	2018-03-29 09:04:15	Time:2018-03-27 17:56:59
System_SyncSysTime	Notice	2018-03-29 09:02:27	Address:10.15.6.95 NewTime:2018-03-29 09:02:24 OldTime:2018-03-29 09:02:24
System_SyncSysTime	Notice	2018-03-27 17:32:04	Address:10.15.6.96 NewTime:2018-03-27 17:32:04 OldTime:2018-03-27 17:32:04
StartUp	Notice	2018-03-27 17:30:14	Flag:ExitPowerFail
About	Notice	2018-03-27 17:30:14	Time:2018-03-27 16:11:47
System_SyncSysTime	Notice	2018-03-27 15:23:42	Address:10.15.6.96 NewTime:2018-03-27 15:23:42 OldTime:2018-03-27 15:23:42
System_SyncSysTime	Notice	2018-03-27 15:21:04	Address:10.15.6.95 NewTime:2018-03-27 15:21:04 OldTime:2018-03-27 15:21:04
StartUp	Notice	2018-03-27 15:20:07	Flag:ExitNormal
Reboot	Notice	2018-03-27 15:18:41	Address:127.0.0.1 Time:2018-03-27 15:18:41
System_SyncSysTime	Notice	2018-03-27 14:20:09	Address:10.15.6.96 NewTime:2018-03-27 14:20:09 OldTime:2018-03-27 14:20:09
StartUp	Notice	2018-03-27 14:19:28	Flag:ShutDownReboot
About	Notice	2018-03-27 14:19:28	Time:2018-03-27 12:45:46
System_SyncSysTime	Notice	2018-03-27 14:17:34	Address:10.15.6.95 NewTime:2018-03-27 14:17:33 OldTime:2018-03-27 14:17:33
ShutDown	Notice	2018-03-27 12:45:54	Time:2018-03-27 12:45:54
System_SyncSysTime	Notice	2018-03-27 10:01:22	Address:10.15.6.96 NewTime:2018-03-27 10:01:21 OldTime:2018-03-27 10:01:21

Figure 5-69

- Connect USB device and then click , it is to export log information to the USB storage device.



#### CAUTION

You may not track the system error reason if you clear log.

#### 5.10.1.2 User operation log

It is to search or export user operation log including user operation log or the configuration log.

#### Steps



Step 1 On Live interface, click , from Maintain->Log->User.

Enter user log interface.

Step 2 Set search criteria including type, user name and date.

 **Note**

- Click Reset to restore default search criteria.
- Click  to set device you want to search.

Step 3 Click Search.

Enter search results interface. See Figure 5-70.

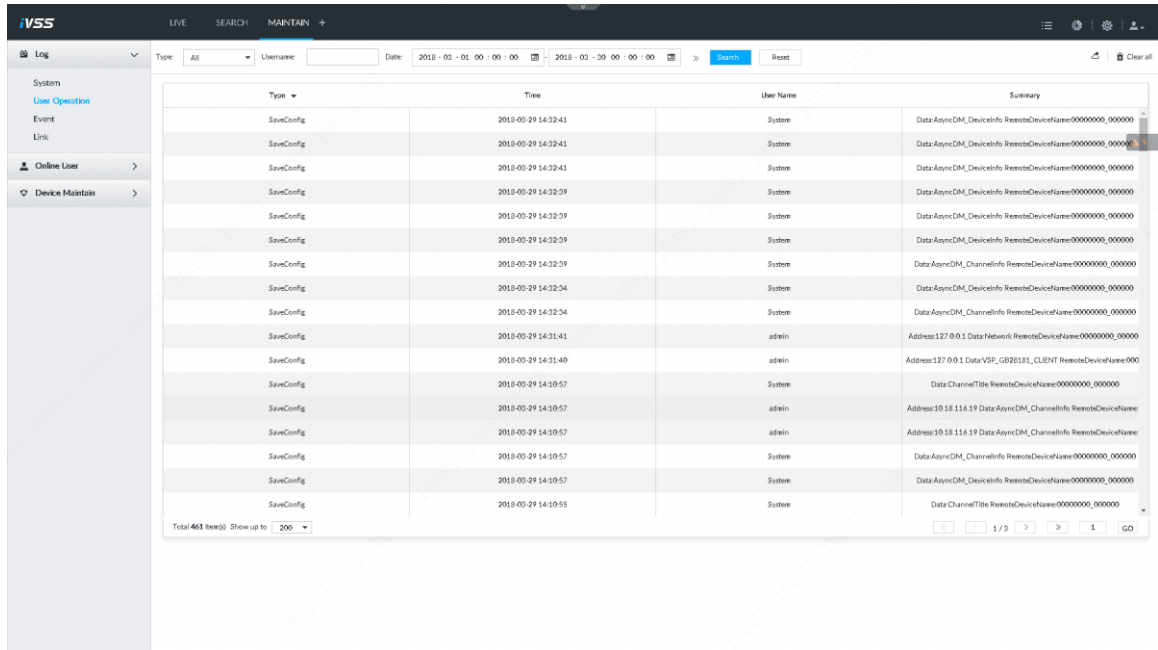

Type	Time	User Name	Summary
SaveConfig	2018-03-29 14:32:41	System	Data AsyncDM_DeviceInfo RemoteDeviceName:00000000_000000
SaveConfig	2018-03-29 14:32:41	System	Data AsyncDM_DeviceInfo RemoteDeviceName:00000000_000000
SaveConfig	2018-03-29 14:32:41	System	Data AsyncDM_DeviceInfo RemoteDeviceName:00000000_000000
SaveConfig	2018-03-29 14:32:39	System	Data AsyncDM_DeviceInfo RemoteDeviceName:00000000_000000
SaveConfig	2018-03-29 14:32:39	System	Data AsyncDM_DeviceInfo RemoteDeviceName:00000000_000000
SaveConfig	2018-03-29 14:32:39	System	Data AsyncDM_ChannelInfo RemoteDeviceName:00000000_000000
SaveConfig	2018-03-29 14:32:34	System	Data AsyncDM_DeviceInfo RemoteDeviceName:00000000_000000
SaveConfig	2018-03-29 14:32:34	System	Data AsyncDM_ChannelInfo RemoteDeviceName:00000000_000000
SaveConfig	2018-03-29 14:31:41	admin	Address:127.0.0.1 Data:Network RemoteDeviceName:00000000_000000
SaveConfig	2018-03-29 14:31:40	admin	Address:127.0.0.1 Data:VSP_GD20181_CLIENT RemoteDeviceName:00000000_000000
SaveConfig	2018-03-29 14:10:57	System	Data ChannelTitle RemoteDeviceName:00000000_000000
SaveConfig	2018-03-29 14:10:57	admin	Address:10.18.116.19 Data:AsyncDM_ChannelInfo RemoteDeviceName:00000000_000000
SaveConfig	2018-03-29 14:10:57	admin	Address:10.18.116.19 Data:AsyncDM_ChannelInfo RemoteDeviceName:00000000_000000
SaveConfig	2018-03-29 14:10:57	System	Data AsyncDM_ChannelInfo RemoteDeviceName:00000000_000000
SaveConfig	2018-03-29 14:10:57	System	Data AsyncDM_DeviceInfo RemoteDeviceName:00000000_000000
SaveConfig	2018-03-29 14:10:55	System	Data ChannelTitle RemoteDeviceName:00000000_000000

Figure 5-70

- Connect USB device and then click , it is to export log information to the USB storage device.



**CAUTION**

You may not track the system error reason if you clear log.

5.10.1.3 Event Log

It is to search or export alarm event log.

**Steps**

Step 1 On Live interface, click , from Maintain->Log->Event.

Enter event log interface.

Step 2 Set search criteria such as type, user name and date.

 **Note**

Click Reset to restore default search criteria.

Step 3 Click Search.

Enter search results interface. See Figure 5-71.

Type	Level	Time	Summary
VideoMotion	Warning	2018-03-29 15:13:09	Code:VideoMotion RegionName:Region1 RemoteDeviceAddress:10.15.23.95
VideoMotion	Warning	2018-03-29 15:12:21	Code:VideoMotion RemoteDeviceAddress:10.15.23.95 RemoteDeviceName:...
VideoMotion	Warning	2018-03-29 15:12:19	Code:VideoMotion RemoteDeviceAddress:10.15.23.95 RemoteDeviceName:...
VideoMotion	Warning	2018-03-29 15:11:50	Code:VideoMotion RemoteDeviceAddress:10.15.23.95 RemoteDeviceName:...
VideoMotion	Warning	2018-03-29 15:10:45	Code:VideoMotion RegionName:Region1 RemoteDeviceAddress:10.15.23.95
VideoMotion	Warning	2018-03-29 15:10:11	Code:VideoMotion RemoteDeviceAddress:10.15.23.95 RemoteDeviceName:...
VideoMotion	Warning	2018-03-29 15:09:25	Code:VideoMotion RemoteDeviceAddress:10.15.23.95 RemoteDeviceName:...
VideoMotion	Warning	2018-03-29 15:08:57	Code:VideoMotion RemoteDeviceAddress:10.15.23.95 RemoteDeviceName:...
VideoMotion	Warning	2018-03-29 15:08:16	Code:VideoMotion RegionName:Region1 RemoteDeviceAddress:10.15.23.95
VideoMotion	Warning	2018-03-29 15:07:57	Code:VideoMotion RemoteDeviceAddress:10.15.23.95 RemoteDeviceName:...
VideoMotion	Warning	2018-03-29 15:07:49	Code:VideoMotion RegionName:Region1 RemoteDeviceAddress:10.15.23.95
VideoMotion	Warning	2018-03-29 15:07:52	Code:VideoMotion RemoteDeviceAddress:10.15.23.95 RemoteDeviceName:...
VideoMotion	Warning	2018-03-29 15:07:22	Code:VideoMotion RegionName:Region1 RemoteDeviceAddress:10.15.23.95
VideoMotion	Warning	2018-03-29 15:07:01	Code:VideoMotion RemoteDeviceAddress:10.15.23.95 RemoteDeviceName:...
VideoMotion	Warning	2018-03-29 15:06:51	Code:VideoMotion RegionName:Region1 RemoteDeviceAddress:10.15.23.95
VideoMotion	Warning	2018-03-29 15:06:51	Code:VideoMotion RemoteDeviceAddress:10.15.23.95 RemoteDeviceName:...
VideoMotion	Warning	2018-03-29 15:06:26	Code:VideoMotion RegionName:Region1 RemoteDeviceAddress:10.15.23.95

Figure 5-71

- Connect USB device and then click , it is to export log information to the USB storage device.



### CAUTION

You may not track the system error reason if you clear log.

- Click  to view event log detailed information.

#### 5.10.1.4 Connection log

It is to search or export connection log including user login/logout, session hijack and session explosion and remote device.

#### Steps

Step 1 On Live interface, click , from Maintain->Log->Link.

Enter link log interface.

Step 2 Set search criteria such as type, user name and date.

#### Note

- Click Reset to restore default search criteria.

Step 3 Click Search.

Enter search results interface. See Figure 5-72.

Type	Level	Time	User Name	Summary
Login	Notice	2018-03-29 15:05:57	admin	Address:10.18.114.19 Type:DVRIP
Login	Notice	2018-03-29 15:05:57	admin	Address:59.18.114.19 Type:Web3.0
Logout	Notice	2018-03-29 15:09:29	admin	Address:127.0.0.1 Type:Web3.0
Logout	Notice	2018-03-29 14:34:04	admin	Address:59.18.114.19 Type:Web3.0
Logout	Notice	2018-03-29 14:32:45	admin	Address:10.15.6.96 Type:DVRIP
RebootDevice	Notice	2018-03-29 14:32:41	System	RebootDeviceName:2C00F56YAZW0015 info_log.logtype
RebootDevice	Notice	2018-03-29 14:32:41	System	RebootDeviceName:2E00FF7YAW00007 info_log.logtype
RebootDevice	Notice	2018-03-29 14:32:40	System	RebootDeviceName:4A041C3YAGEB8C7 info_log.logtype
RebootDevice	Notice	2018-03-29 14:32:39	System	RebootDeviceName:2C00F56YAZW0015 info_log.logtype
RebootDevice	Notice	2018-03-29 14:32:39	System	RebootDeviceName:2E00FF7YAW00007 info_log.logtype
RebootDevice	Notice	2018-03-29 14:32:34	System	RebootDeviceName:4A041C3YAGEB8C7 info_log.logtype
Login	Notice	2018-03-29 14:31:41	admin	Address:10.15.6.96 Type:DVRIP
Logout	Notice	2018-03-29 14:31:41	admin	Address:10.15.6.96 Type:DVRIP
Logout	Notice	2018-03-29 14:31:41	admin	Address:10.18.114.19 Type:DVRIP
Logout	Notice	2018-03-29 14:31:29	admin	Address:127.0.0.1 Type:Web3.0
RebootDevice	Notice	2018-03-29 14:10:57	System	RebootDeviceName: info_log.logtypeLogin_w_Address1

Figure 5-72

- Connect USB device and then click , it is to export log information to the USB storage device.



**CAUTION**

You may not track the system error reason if you clear log.

- Click  to view connection log detailed information.

**5.10.2 Online User**

It is to search remote access network user information or you can block a user from access for a period of time. During the block period, the selected user cannot access the device.



**Note**

Cannot block yourself or block **admin**.

**Steps**

Step 1 On Live interface, click , from Maintain->Online user->Online user.

Enter online user interface. See Figure 5-73.



**Note**

- The list displays the connected user information.

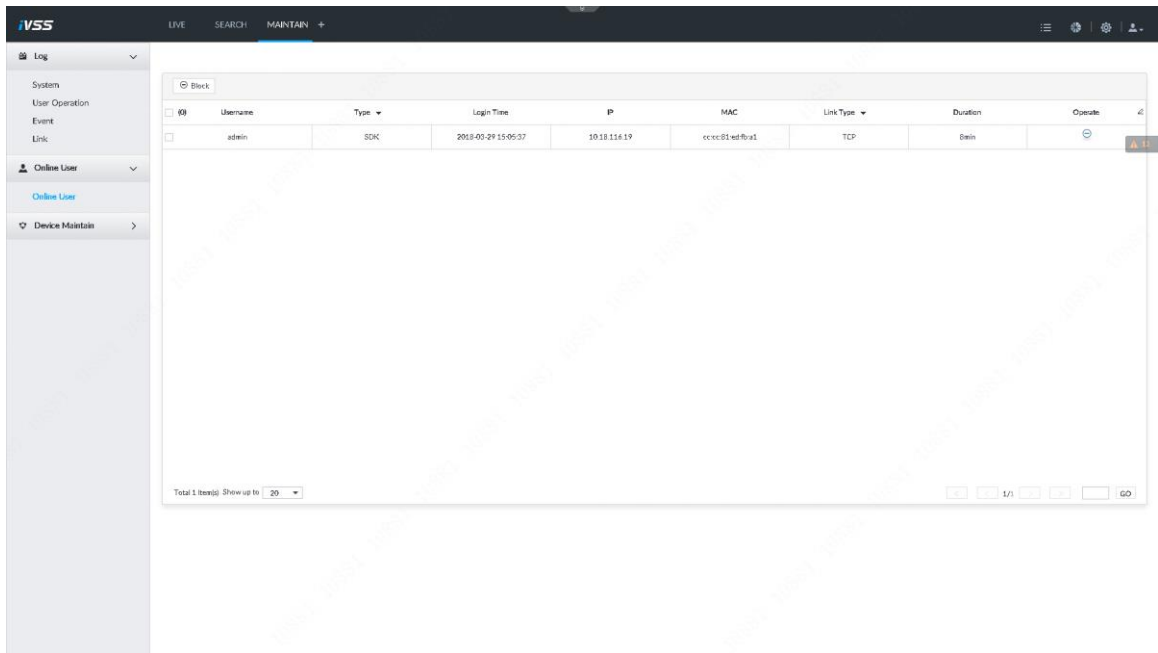



Figure 5-73

Step 2 Select a user you want to block and then click . Enter block interface. See Figure 5-74.

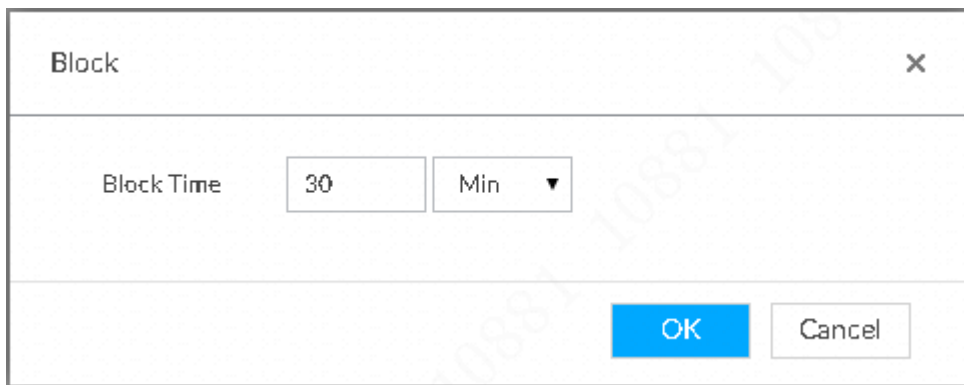

Figure 5-74

Step 3 Set block period. The default period is 30 minutes.

Step 4 Click OK.

### 5.10.3 Device Maintenance

Device maintenance is to reboot device, restore factory default setup, or upgrade system ,etc. It is to clear the malfunction or error during the system operation and enhance device running performance.

#### 5.10.3.1 Upgrade Device

It is to upgrade device or the AI module version.

##### 5.10.3.1.1 Upgrade system

It is to import the upgrade file, upgrade device version. The upgrade file extension name shall be .bin.



### CAUTION

- During the upgrade process, do not unplug the power cable, network cable, reboot or shut down the

device.

- Make sure the upgrade file is right. Improper upgrade file may result in device error!

Step 1 On Live interface, click , from Maintain->Device maintain->Upgrade->Host.

Enter host interface. See Figure 5-75.

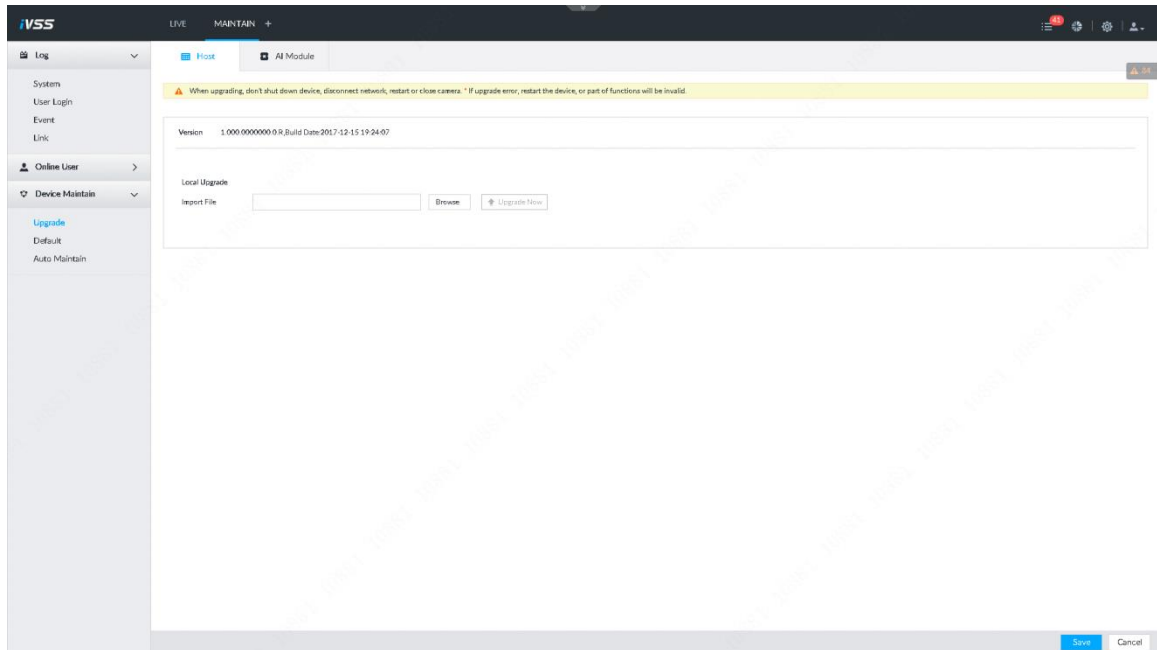

Figure 5-75

Step 2 Connect the USB device that contain the upgrade file to the system.

 **Note**

This step is for local menu operation only.

Step 3 Click Browse to select an upgrade file.

Step 4 Click Upgrade now.

System begins upgrade. Device automatically reboots after successfully upgraded.

#### 5.10.3.1.2 Upgrade AI module

It is to upgrade the system version on the AI module installed on the device.



**CAUTION**

- During the upgrade process, do not unplug the power cable, network cable, reboot or shut down the device.
- Make sure the upgrade file is right. Improper upgrade file may result in device error!
- System cannot upgrade different AI modules at the same time.

### Preparation

- Make sure you have the proper upgrade file.
- The AI module you want to upgrade is online.

### Steps

Step 1 On Live interface, click , from Maintain->Device maintain->Upgrade->AI Module.

Enter AI module interface. See Figure 5-76.

**Note**

- means AI module is online.
- Click the Reboot button of the corresponding AI module, it is to reboot the AI module.

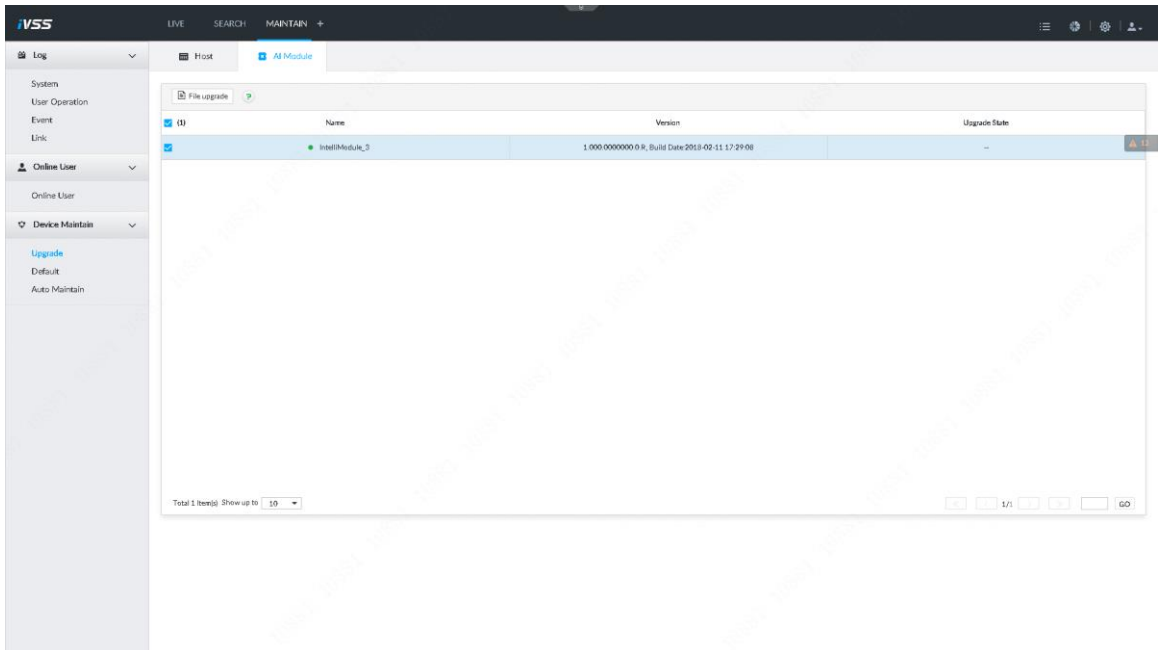

Figure 5-76

Step 2 Connect the USB device that contains the upgrade file to the system.

**Note**

This step is for local menu operation only.

Step 3 Click File upgrade.

System enters Open interface.

Step 4 Select upgrade file and then click OK button.

Device begins upgrade. After the upgrade is complete, AI module automatically reboots.

### 5.10.3.2 Factory Default



**CAUTION**

All configurations are lost after factory default operation.

**Steps**

Step 1 On Live interface, click , from Maintain->Device maintain->Default.  
Enter Default interface. See Figure 5-77.

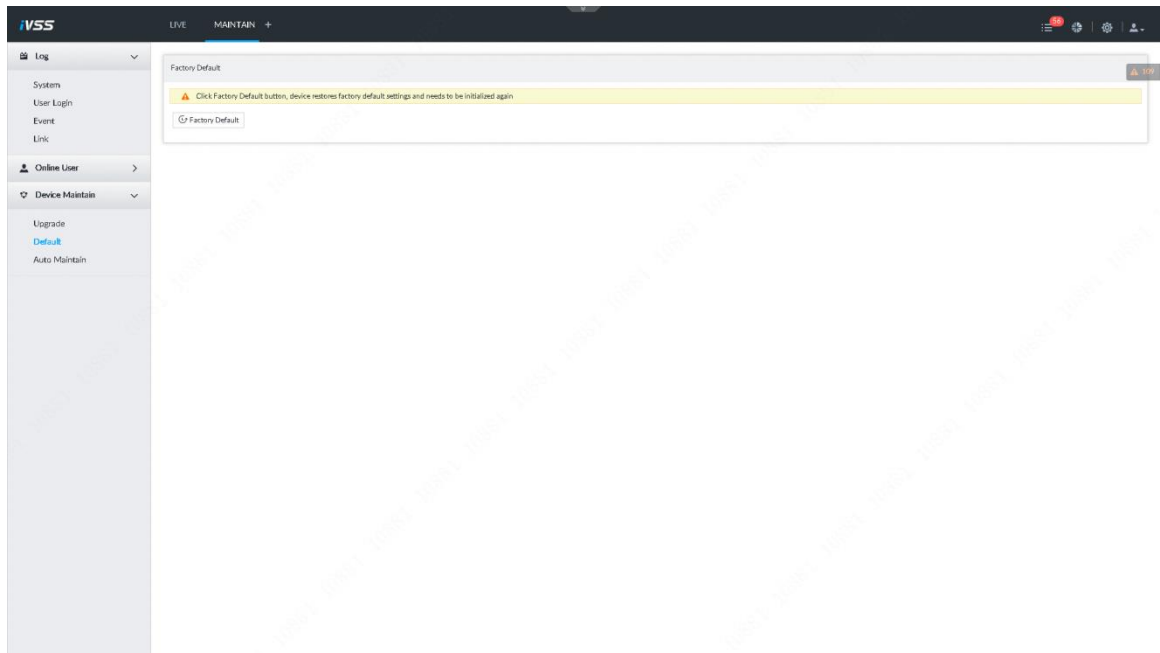

Figure 5-77

Step 2 Click Factory default.

System begins resuming default settings. Device module automatically reboots after successfully restored default settings.

### 5.10.3.3 Auto Maintain

Once the device is running for a long time, you can set to automatically reboot the device at idle time.

#### Steps

Step 1 On Live interface, click **+**, from Maintain->Device maintain->Auto maintain.

Enter Auto maintain interface. See Figure 5-78.

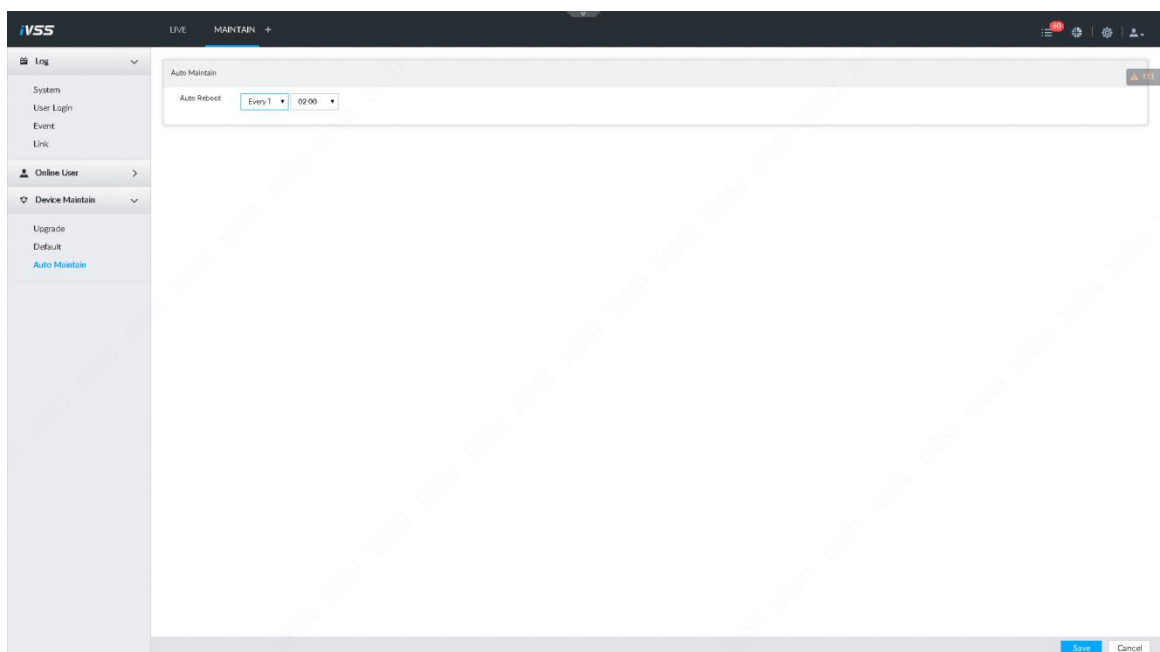

Figure 5-78



Step 2 Set auto reboot time.

Step 3 Click Save.



## 6 System Configuration

This chapter is to introduce system configuration such as manage remote device, set network, set alarm event, set HDD storage, manage user information, set device security strategy, set system parameters ,etc.

### 6.1 Configuring Interface

Click , system displays setting interface. See Figure 6-1.

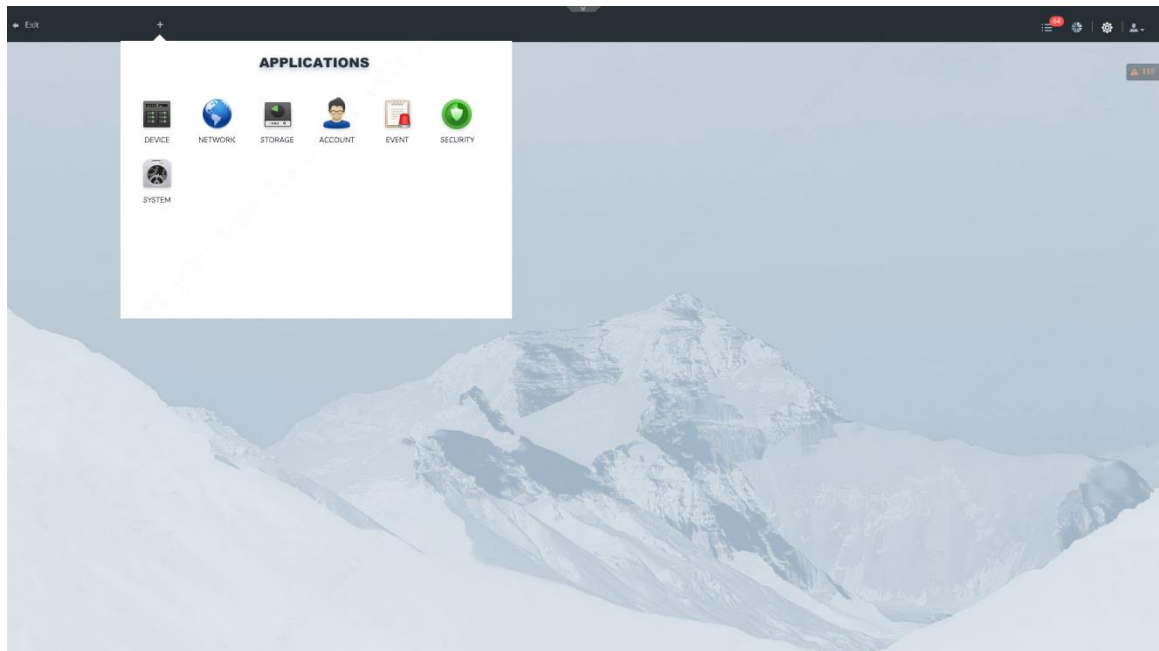





Figure 6-1

On the Setting interface, you can :

- Click  to display or hide applications interface. When all applications are open, device does not display this icon any more.
- Click the corresponding app icon to go to the corresponding interface. The task column displays current running app name. Move the cursor to the app name and then click  to close the app.
- Click  to exit.

### 6.2 Device Manager

It is to set the properties of the device or the remote device, schedule record ,etc.

On the Setting interface click  and then select Device, enter device manager interface. See Figure 6-2.

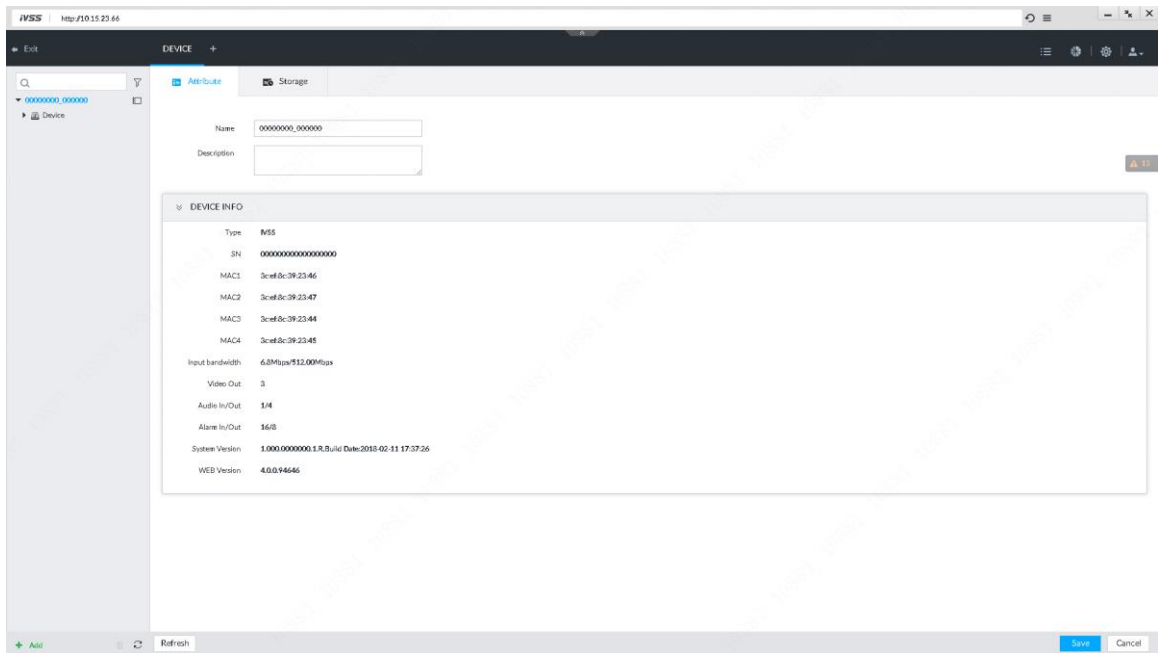

Figure 6-2

## 6.2.1 Local Device

It is to set device properties and schedule record.

### 6.2.1.1 Set properties

It is to set device name, view device information ,etc.

### Steps

- Step 1 On the Setting interface, click  and then select Device.  
Enter Device manager interface.
- Step 2 Select the root of the device list and then click Attribute tab.  
Enter Attribute interface. See Figure 6-3.

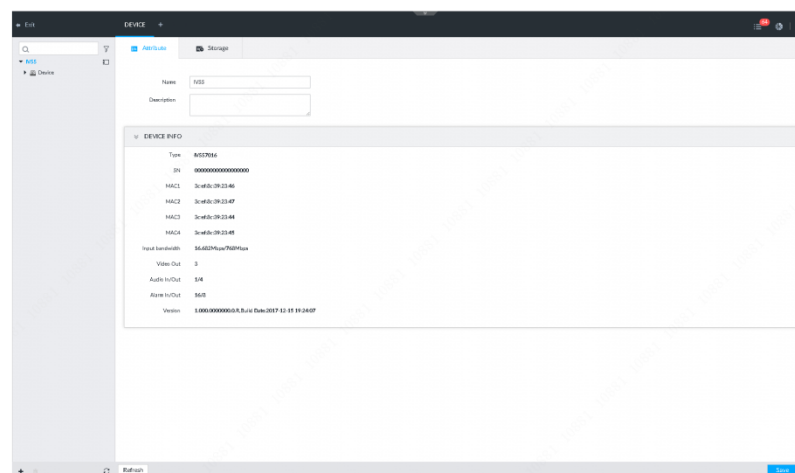

Figure 6-3

- Step 3 Set parameters.

Name	Function
Name	It is to set device name.

Name	Function
Description	It is to input device description
Info	It is to display device information such as device model, SN, MAC address, connected audio/video network bandwidth, alarm input/output amount, system version.

Step 4 Click Save button.

### 6.2.1.2 Schedule

It is to set device global record and image storage plan.



#### Note

In this interface, the record and image storage plan is for all registered remote device. You can select one remote device to set specified storage plan. Refer to chapter 6.2.2.4.5 Storage plan for detailed information.

### Steps

Step 1 On Setting interface click , or click  and then select Device.

Enter device management interface.

Step 2 Select Device on the left pane and then click Storage tab.

Enter storage interface. See Figure 6-4.

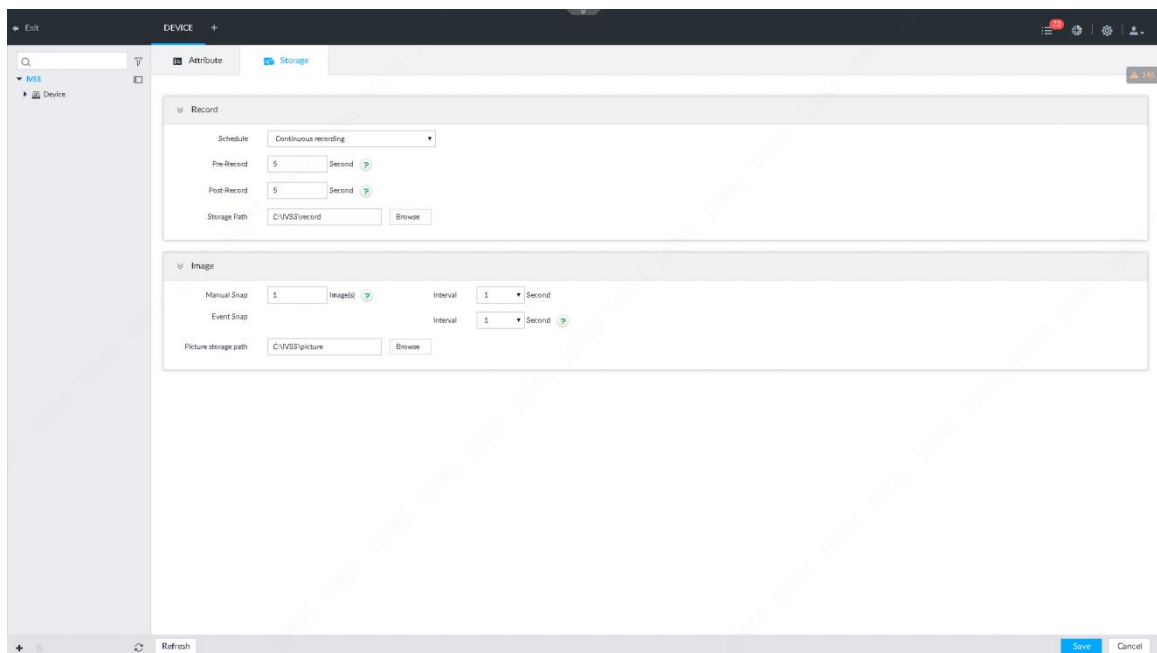





Figure 6-4

Step 3 Set parameters.

Name	Function
Record	<p>Schedule</p> <p>It is to set record strategy.</p> <ul style="list-style-type: none"> <li>• Continuous: Device records for all day.</li> <li>• No record: Device does not record.</li> <li>• Event: Device only records when there is corresponding alarm event.</li> </ul>

Name		Function
	Manual record length	It is to set manual record file length. On the Preview interface, click  to start record. If you do not click the icon to stop record, system stops recording automatically according to the record length here.
	Storage path	Click Browser to set manual record saved path.  <b>Note</b> This item is for WEB interface or the IVSS browser operation only.
	Record stream	It is to set record bit stream type. It includes main stream, sub stream 1, sub stream 2.
Image	Manual snap	It is to set manual snapshot amount and snapshot speed.
	Event snap	It is to set event snapshot interval. Select customize to set customized speed. The max speed is 3600 seconds per image.
	Storage path	Click Browser to set snapshot image saved path.  <b>Note</b> This item is for WEB interface or the IVSS browser operation only.

Step 4 Click Save button.

## 6.2.2 Register

It is to register remote device to the system. Here you can view the real-time video from the remote device, change remote device settings ,etc.

### 6.2.2.1 Register

On the setting interface click  and then select Device. Enter Device manager interface. See Figure 6-5.

Click  or click Addd, it is to register remote device to the system. Refer to chapter 4.4 Register remote device for detailed information.

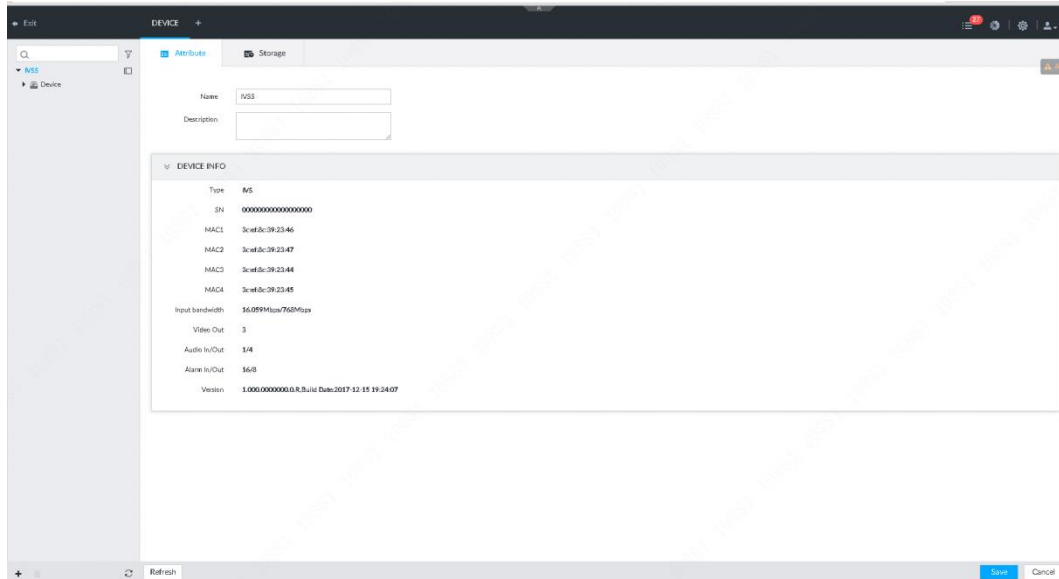





Figure 6-5

### 6.2.2.2 Initialize remote device

After initialize remote device, you can change remote device login password and IP address.

#### Steps

- Step 1 On Setting interface click , or click  and then select Device.  
Enter device management interface.
- Step 2 Click  or click Add, and then select Smart add.  
Enter Smart add interface.
- Step 3 Search remote device.

#### **Note**

System searches the remote devices of current IP segment by default.

1. Click .  
Enter Search setting interface. See Figure 6-6.

Figure 6-6

2. Select manufacturer and set IP address you want to search.
  - IP address: It is to set remote device IP address. System can search the remote device of corresponding IP addresses.
  - IP segment: It is to set remote device IP segment. System can search the remote devices of current IP segment.
3. Click OK to save settings.  
System goes back to Device interface.
4. Click Start search.  
System begins searching remote device and display search results. See Figure 6-7.

<input type="checkbox"/>	Initialization State	Address	Product Model	Manufacturer	Product Type	Sn	Operate
<input type="checkbox"/>	✓ Initialized	10.15.112.33	Android	Private	Android	000000000000...	LIVE
<input type="checkbox"/>	✓ Initialized	10.15.6.85	DHI-NVR2104...	Private	NVR	3H04D39YAZB...	LIVE
<input type="checkbox"/>	✓ Initialized	10.15.6.222	IPC-EBW81230	Private	IPC	3L00BA2PAG0...	LIVE
<input type="checkbox"/>	✓ Initialized	10.15.6.95	DSS Windows	Private	--	--	LIVE
<input type="checkbox"/>	✓ Initialized	0.0.0.0	DSS Windows	Private	--	--	LIVE
<input type="checkbox"/>	✓ Initialized	192.168.1.107	DSS Windows	Private	--	--	LIVE
<input type="checkbox"/>	✓ Initialized	0.0.0.0	DSS Windows	Private	--	--	LIVE
<input type="checkbox"/>	✓ Initialized	10.15.112.34	Android	Private	Android	2M00059YAL0...	LIVE

Total 34 Item(s) Show up to 50

Bandwidth : 12.346Mbps/768Mbps

Figure 6-7

Step 4 Select uninitialized remote device and then click Initialize button.

Enter device initialization interface. See Figure 6-8.

**Note**

Click Initialization status and then select Uninitialized, you can quickly filter the uninitialized remote device.

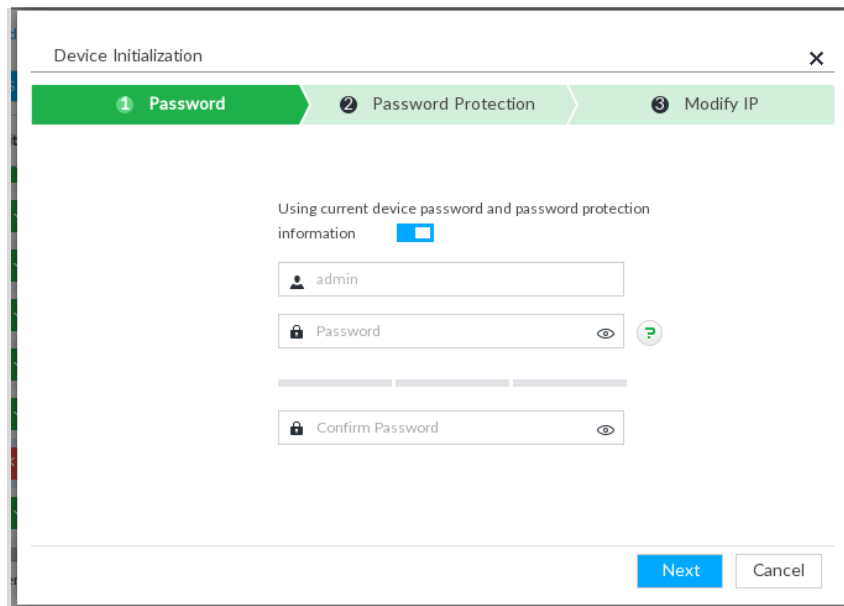

Figure 6-8

Step 5 Set remote device password and password protection.

**Note**

Using current device password and password protection information: Check the box to use current device **admin** account and email information. There is no need to set password and email. Please go to Step 6.

1. Click .

Enter Password setting interface. See Figure 6-9.

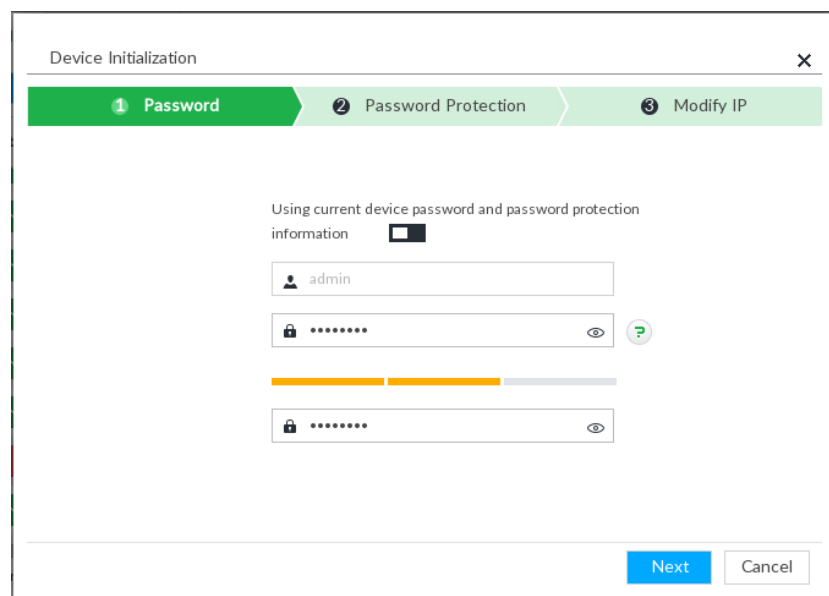





Figure 6-9

2. Set parameters.

Name	Function
User	The default user name is <b>admin</b> .
Password	The password ranges from 8 to 32 digitals. It can contain letters, numbers and special characters (excluding “” , “” , “;” , “.” , “&” ) . The password shall contain at least two categories. Usually we recommend the strong password.
Confirm password	<p> <b>Note</b></p> <p>After input password, use mouse to press  to display password. Release the mouse or move mouse to other position, the password is displayed at hidden mode again.</p>
Prompt question	<p>After you set proper question, move the mouse to the  on the login interface, system displays corresponding password prompt question. It is to help you remember password.</p> <p> <b>Note</b></p> <p>The prompt question function is for local login interface only. Refer to the actual interface for detailed informaiton.</p>

3. Click Next.

Enter password protection interface. See Figure 6-10.

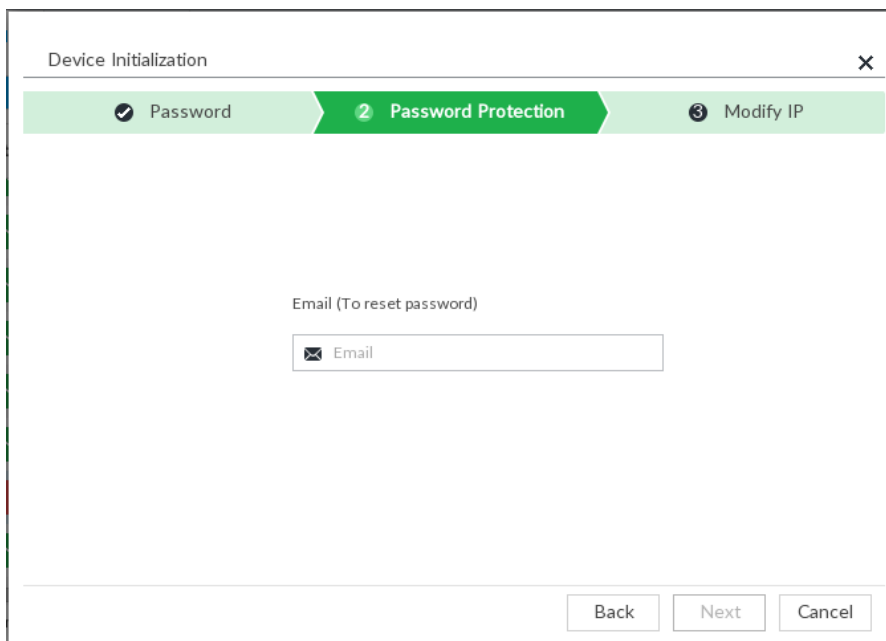

Figure 6-10

4. Set email address.

Input an email address for reset password purpose. You can use the email address here to reset password in case you forgot password in the future.

Step 6 Click Next.

Enter Change IP address interface. See Figure 6-11.



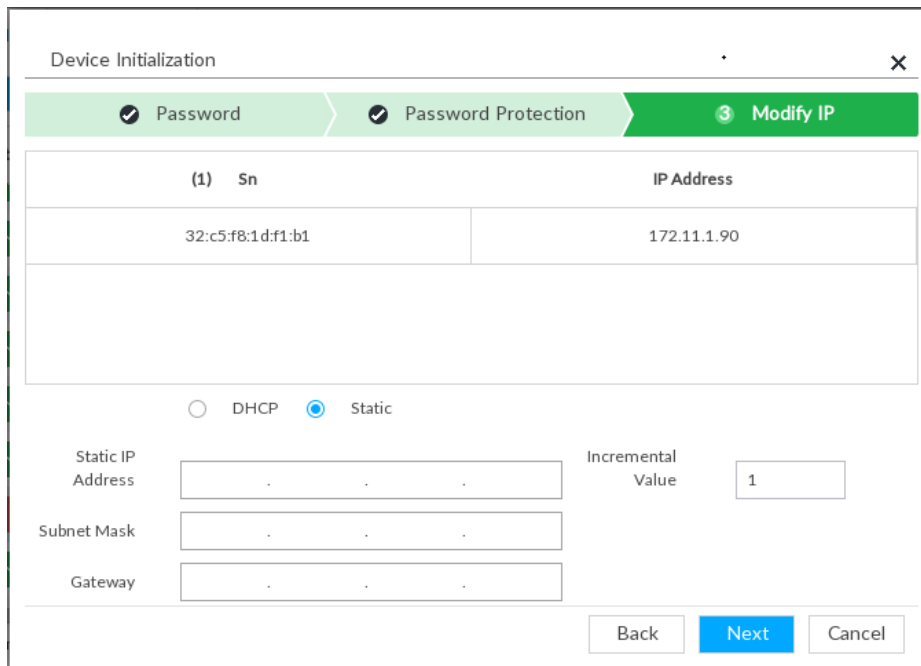

Figure 6-11

Step 7 Set camera IP address.

- Check DHCP, there is no need to input IP address, subnet mask, and default gateway. Device automatically allocates the IP address to the camera.
- Check Static, and then input IP address, subnet mask, default gateway and incremental value. After you input incremental value, system can add the fourth address of the IP address one by one to automatically allocate the IP addresses.

 **Note**

- If you want to change several devices IP addresses at the same time, system allocates IP address one by one according to you set at the fourth bit of the IP address.
- If there is IP conflict when changing static IP address, device pops up IP conflict dialogue box. If batch change IP address, device automatically skips the conflicted IP and begin the allocation according to the incremental value.

Step 8 Click Next button. See Figure 6-12.

System begins initializing camera.

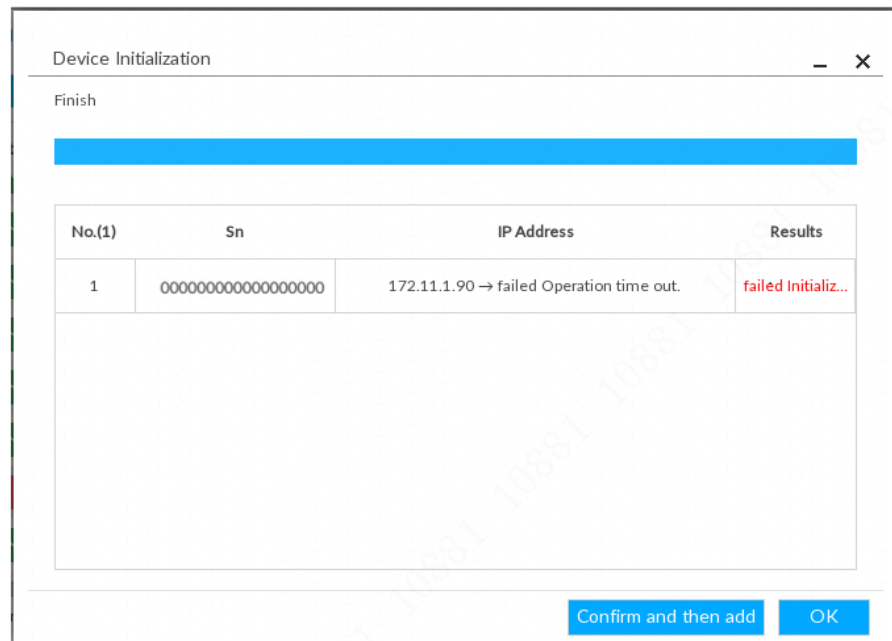

Figure 6-12

Step 9 System completes remote device initialization.

- Click Confirm and then add: System completes initializing the remote device and then add the remote device to the list, system goes back to Add device interface.
- Click OK: System completes initializing remote device. System goes back to Add device interface.

### 6.2.2.3 Change remote device IP address



It is to change the remote device IP address. Please note the device shall have not registered to the system.



**Note**

Refer to Chapter 6.2.2.4.2 Configuring connection information to change the registered device IP address.

### Steps

Step 1 On Setting interface click , or click  and then select Device.  
Enter device management interface.

Step 2 Click  and then select Smart add.  
Enter smart add interface.

Step 3 Search Remote device.



**Note**

System searches the remote devices of current IP segment by default.

1. Click .  
Enter Add setting interface. See Figure 6-13.

**Add**

**Manufacturer**

- All
- Private       Sony       AXIS       Flir
- Bosch       Arecont       Dynacolor       Panasonic
- Samsung       Other

**IP Address**

IP Address     IP Segment

from  to

Figure 6-13

2. Select manufacturer and set IP address you want to search.
  - IP address: It is to set remote device IP address. System can search the corresponding remote device.
  - IP segment: It is to set remote device IP segment. System can search the remote devices of current IP segment.
3. Click OK to save settings.  
System goes back to Device interface.
4. Click Start search.  
System begins searching remote device and display search results. See Figure 6-14.

**Add Device**

Smart Add    Manual Add

   Searching...    34           

<input type="checkbox"/>	(0)	Initialization State	Address	Product Model	Manufacturer	Product Type	Sn	Operate
<input type="checkbox"/>		✓ Initialized	10.15.112.33	Android	Private	Android	000000000000...	<input type="button" value="LIVE"/>
<input type="checkbox"/>		✓ Initialized	10.15.6.85	DHI-NVR2104...	Private	NVR	3H04D39YAZB...	<input type="button" value="LIVE"/>
<input type="checkbox"/>		✓ Initialized	10.15.6.222	IPC-EBW81230	Private	IPC	3L00BA2PAG0...	<input type="button" value="LIVE"/>
<input type="checkbox"/>		✓ Initialized	10.15.6.95	DSS Windows	Private	--	--	<input type="button" value="LIVE"/>
<input type="checkbox"/>		✓ Initialized	0.0.0.0	DSS Windows	Private	--	--	<input type="button" value="LIVE"/>
<input type="checkbox"/>		✓ Initialized	192.168.1.107	DSS Windows	Private	--	--	<input type="button" value="LIVE"/>
<input type="checkbox"/>		✓ Initialized	0.0.0.0	DSS Windows	Private	--	--	<input type="button" value="LIVE"/>
<input type="checkbox"/>		✓ Initialized	10.15.112.34	Android	Private	Android	2M00059YAL0...	<input type="button" value="LIVE"/>

Total 34 Item(s) Show up to 50   

Bandwidth : 12.346Mbps/768Mbps       

Figure 6-14

- Step 4 Select a remote device and then click Modify IP.  
Enter Modify IP interface. See Figure 6-15.

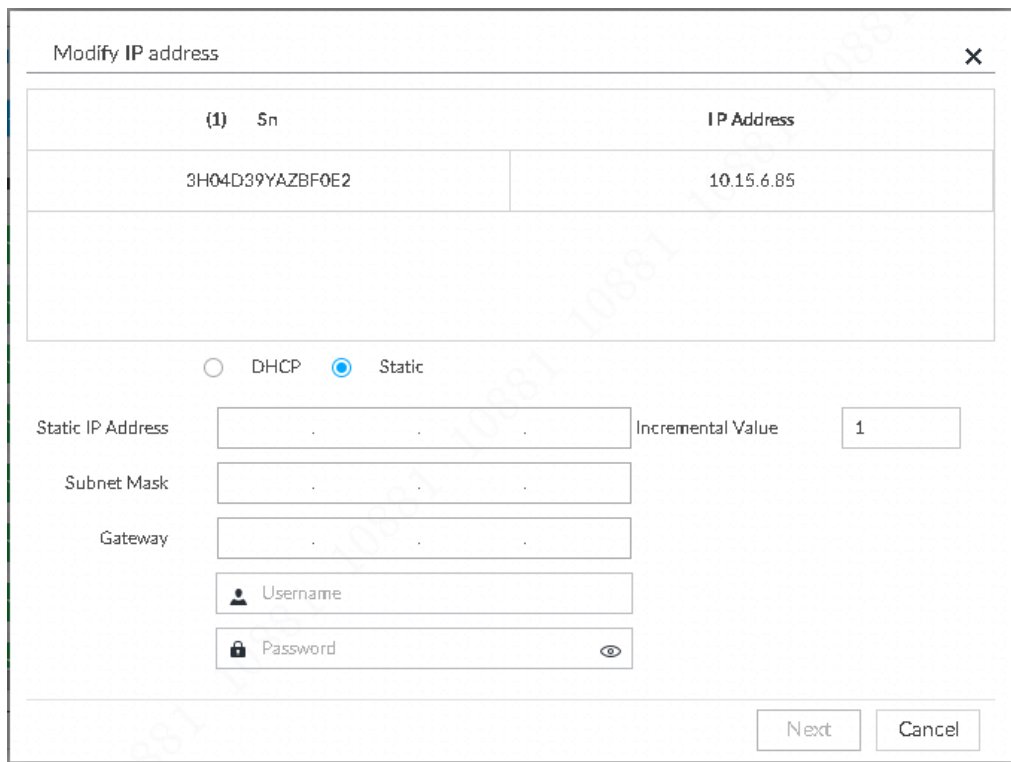

(1) Sn	IP Address
3H04D39YAZBF0E2	10.15.6.85

DHCP     Static

Static IP Address: [ . . . ]    Incremental Value: [ 1 ]  
 Subnet Mask: [ . . . ]  
 Gateway: [ . . . ]  
 Username: [ ]  
 Password: [ ]

Next    Cancel

Figure 6-15

- Step 5 Select IP mode.

- Check DHCP, there is no need to input IP address, subnet mask, and default gateway. Device automatically allocates the IP address to the camera.
- Check Static, and then input IP address, subnet mask, default gateway and incremental value. After you input incremental value, system can add the fourth address of the IP address one by one to automatically allocate the IP addresses.

 **Note**

- If you want to change several devices IP addresses at the same time, system allocates IP address one by one according to you set at the fourth bit of the IP address.
- If there is IP conflict when changing static IP address, device pops up IP conflict dialogue box. If batch change IP address, device automatically skips the conflicted IP and begin the allocation according to the incremental value.

- Step 6 Input remote device user name and password.

 **Note**

- When you are changing several device IP addresses, make sure the user name and password of these remote devices are the same.
- Use mouse to press  to display password. Release the mouse or move mouse to other position, the password is displayed at hidden mode again.

- Step 7 Click Next.

System displays IP address modification interface.

- Step 8 Click OK to complete the modification.

On Smart add interface and then search remote device again, the list displays modified IP

address.

### 6.2.2.4 Set Remote Device

It is to set remote device properties, connection information, video parameters ,etc.



#### Note

Different remote devices have different interfaces. Please refer to the actual interface for detailed information.

#### 6.2.2.4.1 Set Device Properties

It is to set remote device name, view device information ,etc.

### Steps

Step 1 On Setting interface click , or click  and then select Device.

Enter device management interface.

Step 2 Select a remote device on the left pane and then click Attribute tab.

Enter attribute interface. See Figure 6-16.

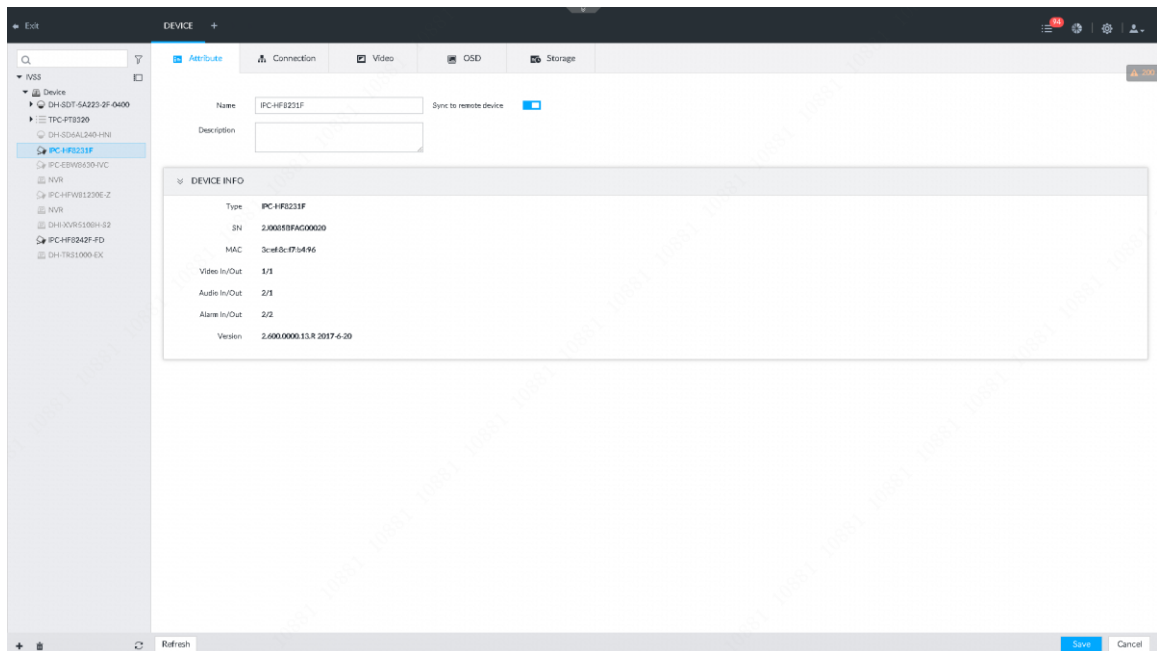

Figure 6-16

Step 3 Set parameters.



Name	Function
Name	It is to set remote device name. After enable sync to the remote device and save the settings. It is to synchronize remote device new name to the remote device.
Description	Input remote device description.
Device info	It is to display remote device information. It includes remote device model, SN, MAC address, audio/video amount, alarm input/output amount, system version.

Step 4 Click OK button.

#### 6.2.2.4.2 Set connection information

It is to set remote device connection information such as IP address, port number ,etc.

### Steps

- Step 1 On Setting interface click , or click  and then select Device.  
Enter device management interface.
- Step 2 Select a remote device on the left pane and then click Connection tab.  
Enter Connection interface. See Figure 6-17

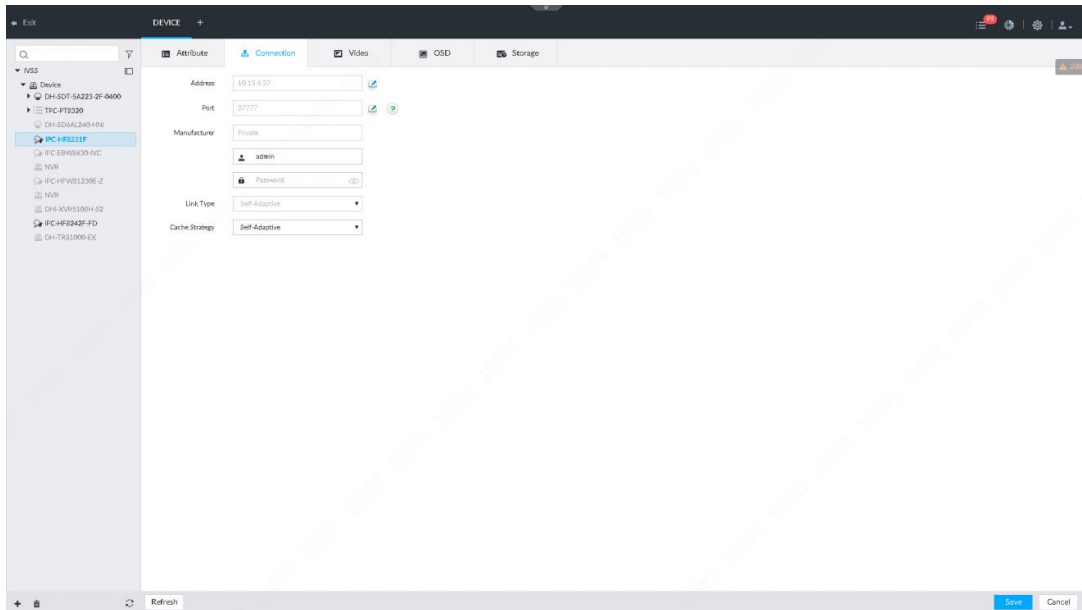



Figure 6-17

- Step 3 Change IP address.

1. Click the  of the corresponding address.  
Enter Modify IP address interface. See Figure 6-18.

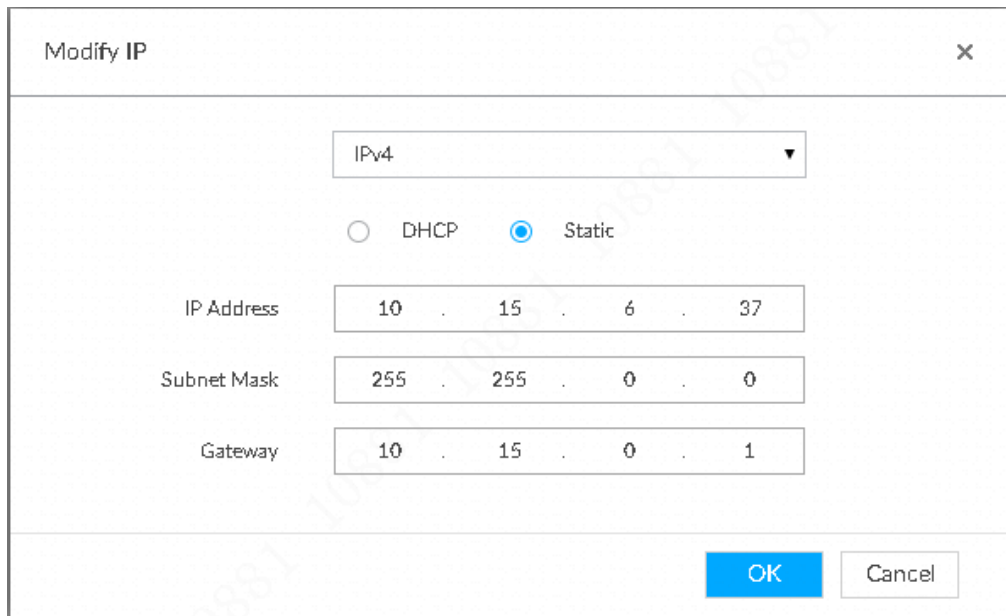

Figure 6-18



2. Select IP mode.
  - Check DHCP, there is no need to input IP address, subnet mask, and default gateway. Device automatically allocates the IP address to the camera.

- Check Static, and then input IP address, subnet mask, default gateway and incremental value. After you input incremental value, system can add the fourth address of the IP address one by one to automatically allocate the IP addresses.



 **Note**

- If you want to change several devices IP addresses at the same time, system allocates IP address one by one according to you set at the fourth bit of the IP address.
- If there is IP conflict when changing static IP address, device pops up IP conflict dialogue box. If batch change IP address, device automatically skips the conflicted IP and begin the allocation according to the incremental value.

Step 4 Change port number.

1. Click the  of the corresponding port.
2. Change port number.
3. Click  to save setting.

Step 5 Set other parameters.

Name	Function
Manufacturer	It is to display the connection protocol of the remote device.
User name	It is to input remote device user name and password.  <b>Note</b>
Password	After input password, use mouse to press  to display password. Release the mouse or move mouse to other position, the password is displayed at hidden mode again.
Connection type	It is to display the system and remote device connection type. It includes TCP, UDP, multicast, self-adaptive.
Buffer strategy	It is to set remote device video stream buffer strategy. <ul style="list-style-type: none"> <li>● Self-adaptive: System automatically adjusts video stream buffer status according to the network bandwidth.</li> <li>● HD: It is to guarantee video quality. When the network bandwidth is not sufficient, the video may not be fluent.</li> <li>● Fluent: It is to guarantee video fluent. When the network bandwidth is not sufficient, the video may not be clear.</li> </ul>

6.2.2.4.3 Set video parameters

It is to set different video parameters according to different bit stream type based on the bandwidth.

**Steps**

Step 1 On Setting interface click , or click  and then select Device.

Enter Device manager interface.

Step 2 Select a remote device on the left pane and then click Video tab.

Enter Video interface. See Figure 6-19.

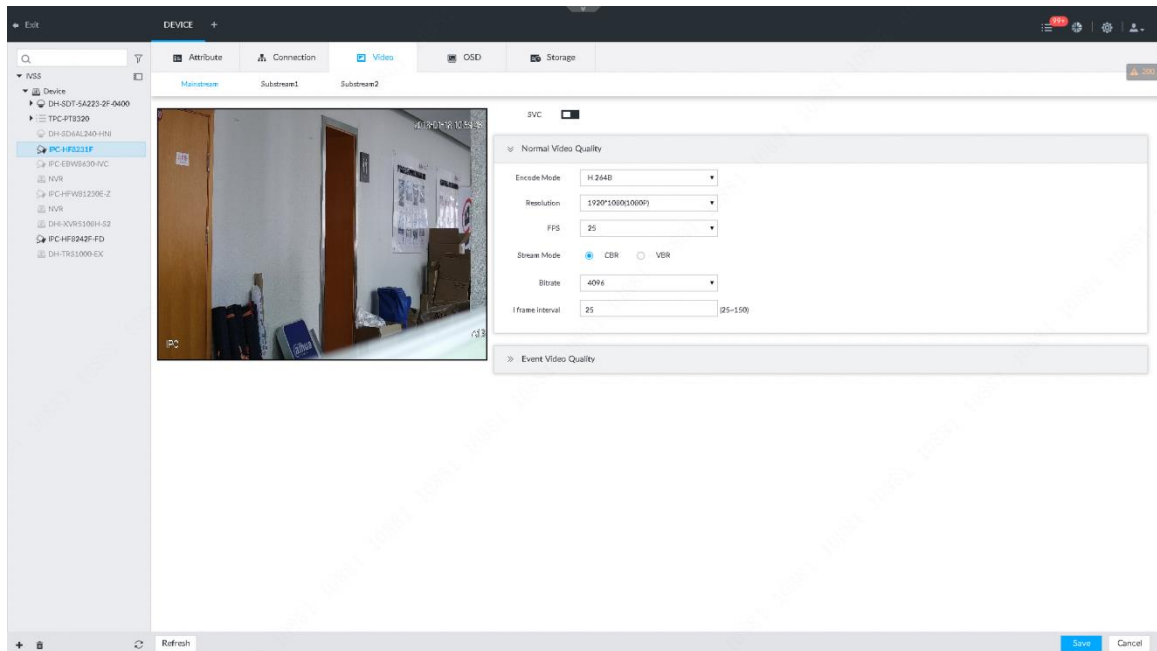

Figure 6-19

- Step 3 Set main stream, sub stream 1, or sub stream 2.  
 Step 4 Set general video quality parameters.

Name	Function
SVC	<p>Check the box to enable SVC function. Select 1 or 2 from the dropdown list on the right. The default setup is 1, there is no scaled encoding.</p> <p> <b>Note</b>            SVC refers to the scaled video coding. It can split the video stream to basic stream and enhanced scale.</p>
Encode mode	<p>It is to set video encode mode.</p> <ul style="list-style-type: none"> <li>H.264: It is a highly compressed video encode/decode standard. At the same video quality, it has increased the compression rate by 2X compared with the MPEG-2.</li> <li>H.265: It is a new video encode standard coming after H.264. It has improved the complicated relationship among bit stream; encode quality, latch and algorithm on the previous standard. It can get the best encode.</li> </ul>
Resolution	<p>It is to set video resolution. The higher the resolution is ,the better the video quality is .</p> <p> <b>Note</b>            Different series products support different resolutions. Refer to the actual interface for detailed information.</p>
Frame rate	<p>It is to set the frame amount displayed at each second. The higher the frame rate is, the more vivid and fluent the video is.</p>
Bit stream mode	<p>It is to set video bit stream control mode.</p> <ul style="list-style-type: none"> <li>CBR: The bit stream changes slightly. The bit stream is near the value you set here.</li> <li>VBR: The bit stream may change according to the environment.</li> </ul>



Name	Function
Quality	It is to set video quality. It includes low, middle, high. <b>Note</b> It is null when the bit stream mode is CBR.
Bit stream	It is to set video stream value. <ul style="list-style-type: none"> <li>• Main stream: the bit stream value is to affect the quality. The higher the bit stream is, the better the video quality is.</li> <li>• Sub stream: On CBR, the bit stream changes around the value you set. On VBR, it changes according to the bit stream value, but its max value is near the specified value.</li> </ul>
I frame interval	It is to set the P frame amount between two I frames. Usually we recommend it is the 2X of the frame rate.

Step 5 Enable event quality and set frame rate, bit stream mode.

**Note**

Event video quality is for main stream only.

Step 6 Click Save button.

#### 6.2.2.4.4 OSD

It is to overlay time information, channel information on the video.

### Steps

Step 1 On Setting interface click , or click and then select Device.

Enter device management interface.

Step 2 Select a remote device on the left pane and then click OSD tab.

Enter OSD interface. See Figure 6-20.

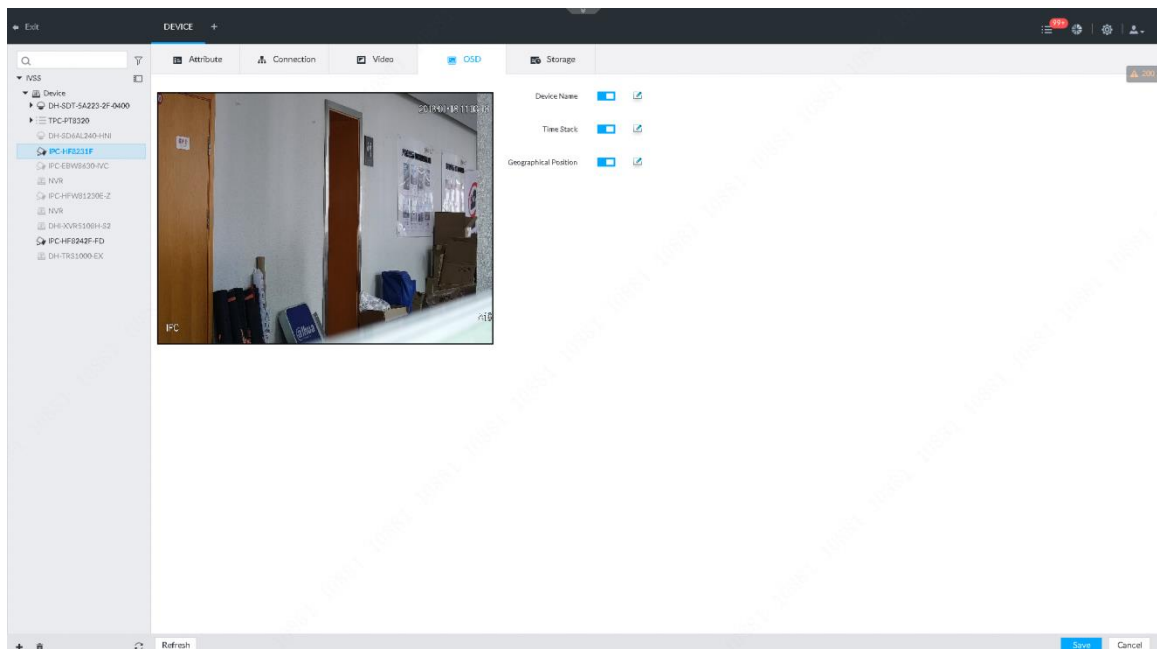

Figure 6-20

Step 3 Enable OSD information according to actual requirements.

1. Click to enable OSD function.

- Click  , the corresponding overlay text column appears on the video window,  
See Figure 6-21 (device name), Figure 6-22 (time), Figure 6-23 (geographic position).



Figure 6-21

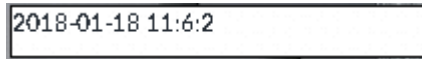

Figure 6-22



Figure 6-23

- Set device name.



**Note**



Skip this step if you do not want to use device name function.

- Set geographical position information.





**Note**

Skip this step if you do not want to use geographical position function.

Click  or  to create a text column. Input the geographical position information.

✧ Click  to adjust font alignment mode.

✧ Click  or , add one text column at the top or the bottom of the text column.

✧ Click  to delete the text column.

- Drag the text column to the proper position.

- Click  to save

Step 4 Click Save button.

#### 6.2.2.4.5 Set storage plan

It is to set remote device video file and image storage plan.

### Steps

Step 1 On Setting interface click , or click  and then select Device.

Enter Device manager interface.

Step 2 Select a remote device on the left pane and then click Storage tab.

Enter Storage interface. See Figure 6-23.

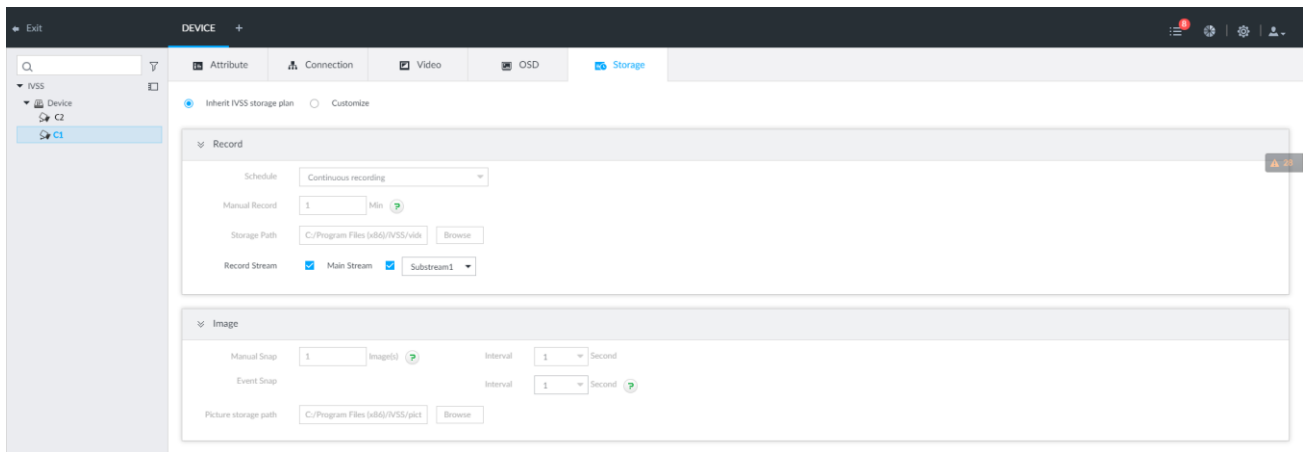

Figure 6-24

Step 3 Set use IVSS storage plan or customize.

- Inherit IVSS storage plan: The remote device adopts the device global storage plan.
- Customize: Set customized storage plan.

Step 4 Set parameters.





**Note**

Please set record bit streams only if you want to inherit IVSS storage plan.

Name		Function
Record	Schedule	It is to set record strategy. <ul style="list-style-type: none"> <li>● Continuous: Device records for all day.</li> <li>● No record: Device does not record.</li> <li>● Event: Device only records when there is corresponding alarm event.</li> </ul>
	Manual record length	It is to set manual record file length. On the Preview interface, click  to start record. If you do not click the icon to stop record, system stops recording automatically according to the record length here.
	Storage path	Click Browser to set manual record saved path. <b>Note</b> This item is for WEB interface or the IVSS browser operation only.
	Record stream	It is to set record bit stream type. It includes main stream, sub stream 1, sub stream 2.
Image	Manual snap	It is to set manual snapshot amount and snapshot speed.
	Event snap	It is to set event snapshot interval. Select customize to set customized speed. The max speed is 3600 seconds per image.
	Storage path	Click Browser to set snapshot image saved path. <b>Note</b> This item is for WEB interface or the IVSS browser operation only.

### 6.2.2.5 Delete remote device

Enter device management interface to delete the registered remote device.

- Delete one by one:
  - ✧ Select a remote device and then click  to delete.
  - ✧ On the device list, right click the remote device and then click Delete.
- Batch delete:
  - ✧ Click , device list displays check box for you to select multiple remote devices. Click  to delete the selected devices.
  - ✧ On the device list and then click one remote device, press **【Ctrl】** to select other remote devices and then click .
  - ✧ On the device list and then click one remote device, press **【Shift】** and then click another remote device, it is to select all remote devices between these two, and then click  to delete.

## 6.3 Network

It is to set device network parameters so that device can communicate with devices on the network.



### 6.3.1 Basic Network

It is to set device network parameters such as IP address, port aggregation and port number.

#### 6.3.1.1 Set IP address

It is to set device IP address, DNS server information ,etc.

### Steps

- Step 1 On Setting interface click , or click  and then select Network->Basic Network->TCP/IPv4.  
Enter TCP/IPv4 interface. See Figure 6-25.

#### Note

Click  to view the NIC parameter information.

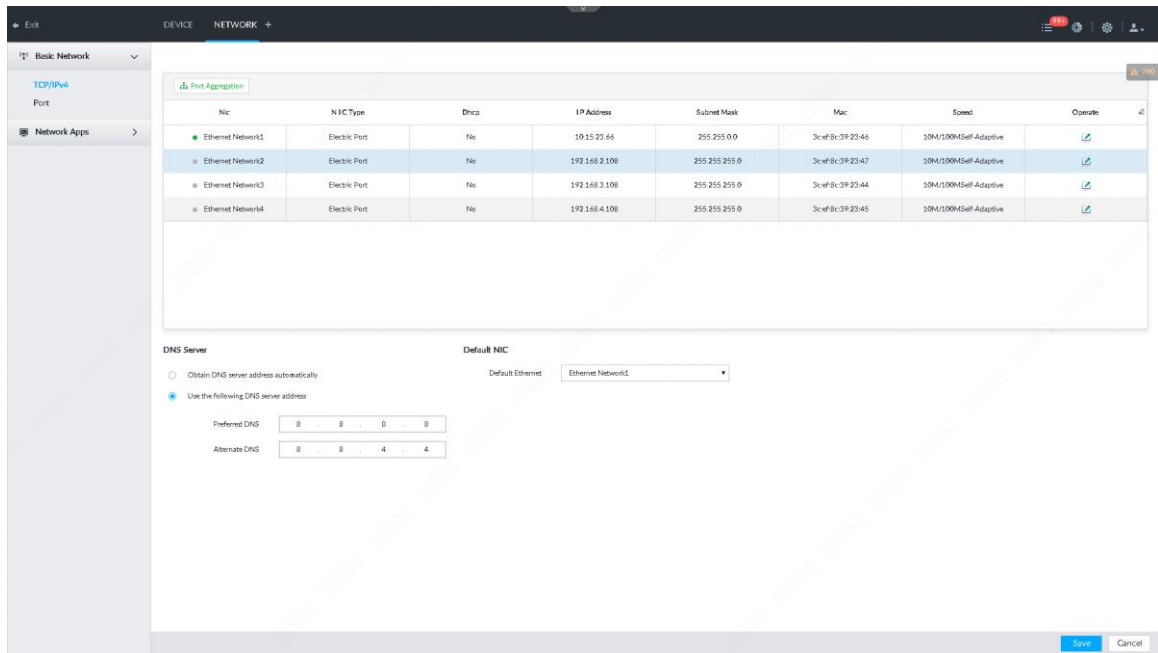

Figure 6-25

Step 2 Click the of the corresponding NIC.  
 Enter edit NIC interface. See Figure 6-26.

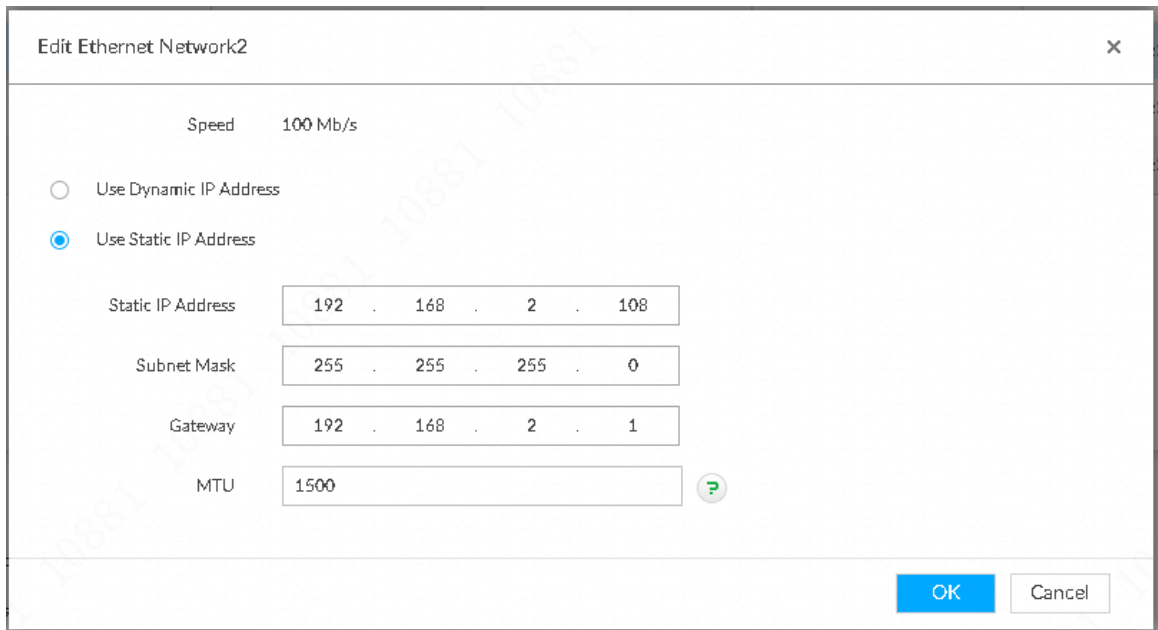



Figure 6-26

Step 3 Set parameters.

Name	Function
Speed	Current NIC max network transmission speed.
Use dynamic IP address	When there is a DHCP server on the network, check the box to use dynamic IP address, system can allocate an dynamic IP address to the device. There is no need to set IP address manually.

Name	Function
Use static IP address	Check the box to use static IP address. Please set static IP address, subnet mask and gateway. It is to set a static IP address for the device.
MTU	<p>Set NIC MTU value. The default setup is 1500 Byte.</p> <p>We recommend you to check the MTU value of the gateway first and then set the device MTU value equal to or smaller than the gateway value. It is to reduce the packets slightly and enhance network transmission efficiency.</p> <p> <b>Caution</b></p> <p>Changing MTU value may result in NIC reboot, network offline and affect current running operation. Please be careful!</p>

Step 4 Click OK.

Go back to TCP/IPv4 interface.

Step 5 Set DNS server information.

You can select to get DNS server manually or input DNS server information.

 **Note**

This step is compulsive if you want to use domain service.

- Auto get DNS server address: Check the box to auto get DNS server address, device can automatically get the DNS server IP address on the network.
- Use the following DNS server address: Check the box to use the following DNS server addresses, and then input primary DNS and alternate DNS IP address.

Step 6 Set default NIC.

Select default NIC from the dropdown list.

 **Note**

Make sure the NIC you want to use is online.

Step 7 Click Save button.



### 6.3.1.2 Port Aggregation

It is to bond multiple NIC and create one logic NIC and use one IP address for peripheral device. The bonded NIC can work as the specified aggregation mode to work. It enhances network bandwidth and network reliability.

#### 6.3.1.2.1 Bind NIC

System supports load balance, fault-tolerance, and link aggregation. Please select bind mode according to your actual requirements.

### Steps

Step 1 On Setting interface click , or click  and then select Network->Basic

Network->TCP/IPv4.

Enter TCP/IPv4 interface. See Figure 6-27.

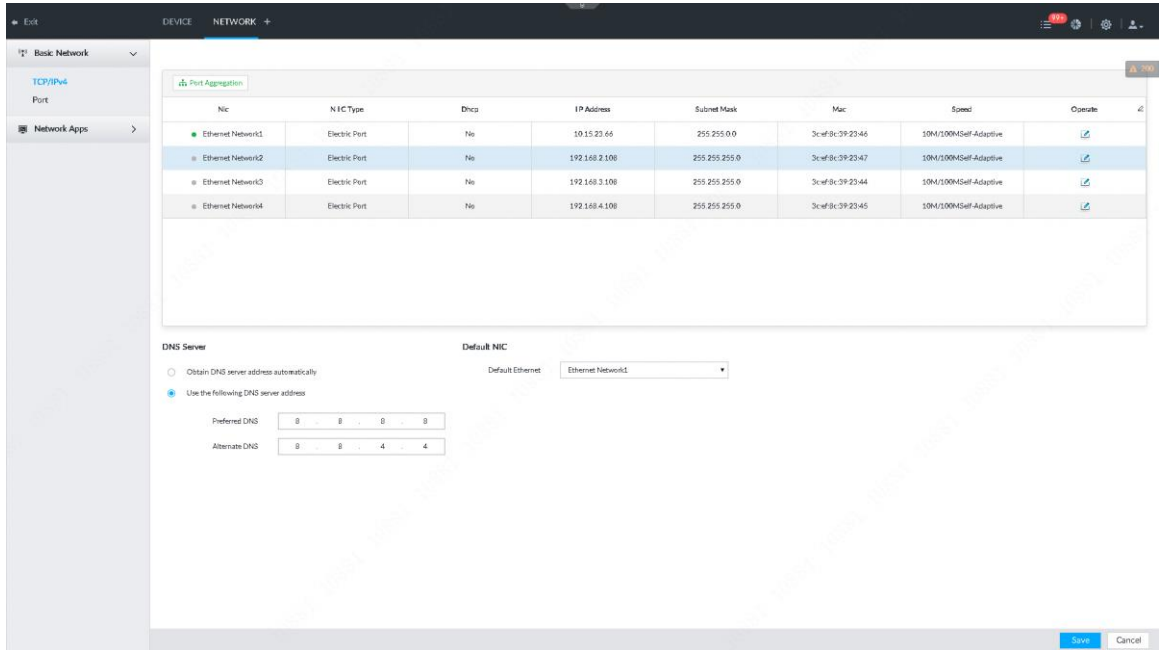

Figure 6-27

Step 2 Bind NIC card.

1. Click Port aggregation.  
Enter Port aggregation interface. See Figure 6-28.

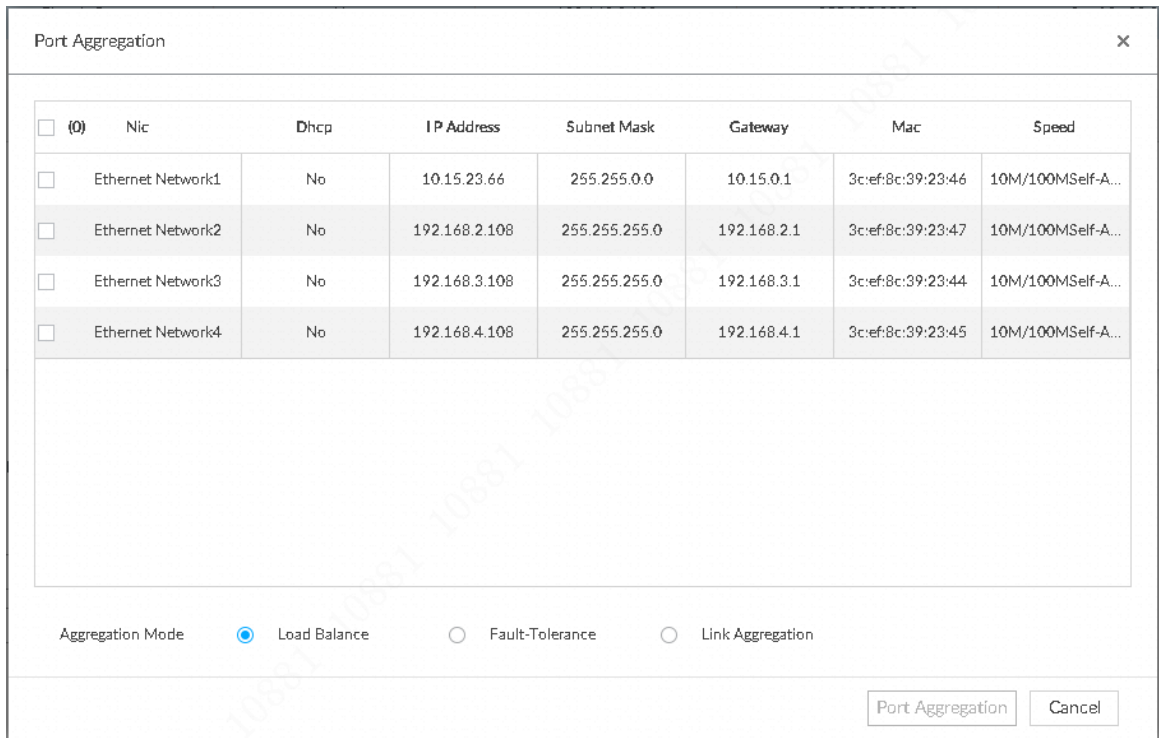



Figure 6-28

2. Select the NIC you want to bind.
3. Select NIC aggregation mode.

Name	Function
------	----------

Name	Function
Load balance	<p>Device has bonded several NICs at the same time and use one IP address to communicate with the external device. The bonded NICs are working together and bear the network load. The load balance mode adds the network input/output data amount and enhance network flexibility and availability. In this mode, the system is shown as offline once all NICs are both offline.</p>
Fault-tolerance	<p>In this mode, device has bonded several NICs and set one NIC as the master card and the rest NICs are the alternative NICs. Usually, only the master NIC card is working. System can automatically enable other alternate card to work when the master card is malfunction.</p> <p>Fault-tolerance is a network mode to enhance NIC reliability. In this mode, the system is shown as offline once these two cards are both offline.</p>
Link aggregation	<p>Device has bonded several NICs and all NICs are working together and share the network load. System allocates data to each NIC according to your allocated strategy. Once the system detects one NIC is malfunction, it stops sending data via this NIC, and then system transmits the data among the rest NICs. System calculates transmission data again after malfunction NIC resumes work.</p> <p>In this mode, the network is offline once all bonded NICs are malfunction.</p> <p> <b>Note</b> Please make sure you switch support link aggregation and you have set the link aggregation mode.</p>

4. Click Port aggregation.

Enter edit port aggregation interface. See Figure 6-29 (load balance). Figure 6-30 (fault tolerance), Figure 6-31 (Link aggregation).



Speed 1100 Mb/s

Use Dynamic IP Address  
 Use Static IP Address

Static IP Address: 172 . 11 . 200 . 201  
 Subnet Mask: 255 . 255 . 0 . 0  
 Gateway: 172 . 11 . 0 . 1  
 MTU: 1500

NIC	Mac	Speed
Ethernet Network1	34:22:3d:da:32:22	10M/100M/1000M Self-Adaptive
Ethernet Network2	34:22:3d:da:32:23	10M/100M Self-Adaptive

OK Cancel

Figure 6-29

Speed 1100 Mb/s

Use Dynamic IP Address  
 Use Static IP Address

Static IP Address: 172 . 11 . 200 . 201  
 Subnet Mask: 255 . 255 . 0 . 0  
 Gateway: 172 . 11 . 0 . 1  
 MTU: 1500

NIC	Mac	Speed
Ethernet Network1	34:22:3d:da:32:22	10M/100M/1000M Self-Adaptive
Ethernet Network2	34:22:3d:da:32:23	10M/100M Self-Adaptive

OK Cancel

Figure 6-30

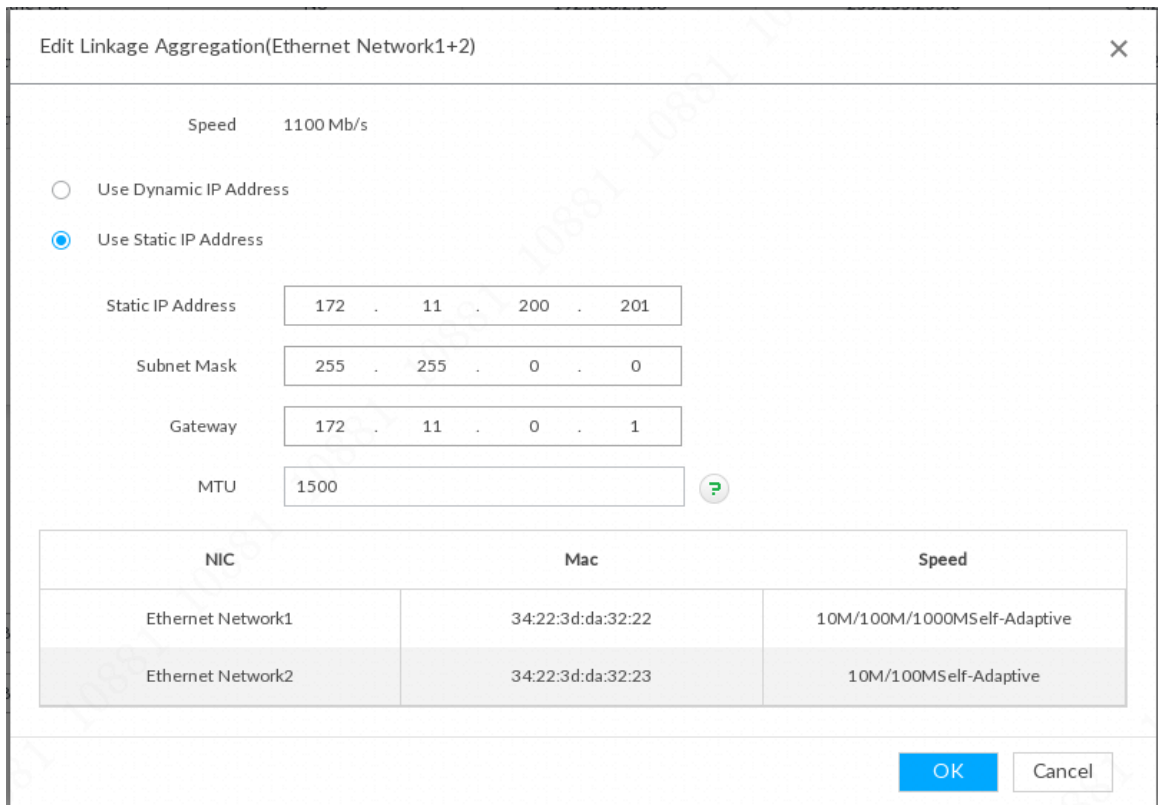



Figure 6-31

5. Set parameters.

Name	Function
Speed	Current NIC max network transmission speed.
Use dynamic IP address	When there is a DHCP server on the network, check the box to use dynamic IP address, system can allocate an dynamic IP address to the device. There is no need to set IP address manually.
Use static IP address	Check the box to use static IP address. Please set static IP address, subnet mask and gateway. It is to set a static IP address for the device.
MTU	<p>Set NIC MTU value. The default setup is 1500 Byte.</p> <p>We recommend you to check the MTU value of the gateway first and then set the device MTU value equal to or smaller than the gateway value. It is to reduce the packets slightly and enhance network transmission efficiency.</p> <p> <b>Caution</b></p> <p>Changing MTU value may result in NIC reboot, network offline and affect current running operation. Please be careful!</p>
Ethernet port	It is to display bonded NIC name, MAC address, network transmission speed.
MAC address	
Speed	

6. Click OK.

System goes back to TCP/IPv4.

Step 3 Click Save to save settings.

System pops up the following dialogue box. See Figure 6-32.

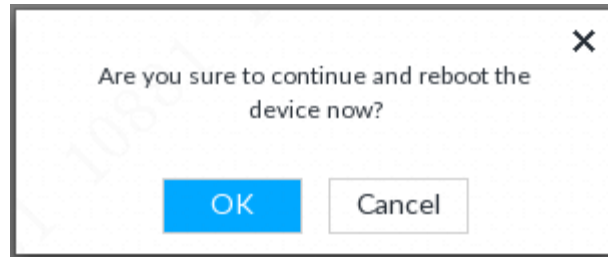

Figure 6-32



Step 4 Click OK to reboot device.

The binding card information becomes activated after reboot operation.

### 6.3.1.2.2 Cancel binding NIC

It is to cancel port aggregation and allow the bonded NICs to work as independent card.

## Steps

Step 1 On Setting interface click , or click  and then select Network->Basic Network->TCP/IPv4.  
Enter TCP/IPv4 interface.

Step 2 Select bond NIC.

System displays Cancel port aggregation interface. See Figure 6-33.

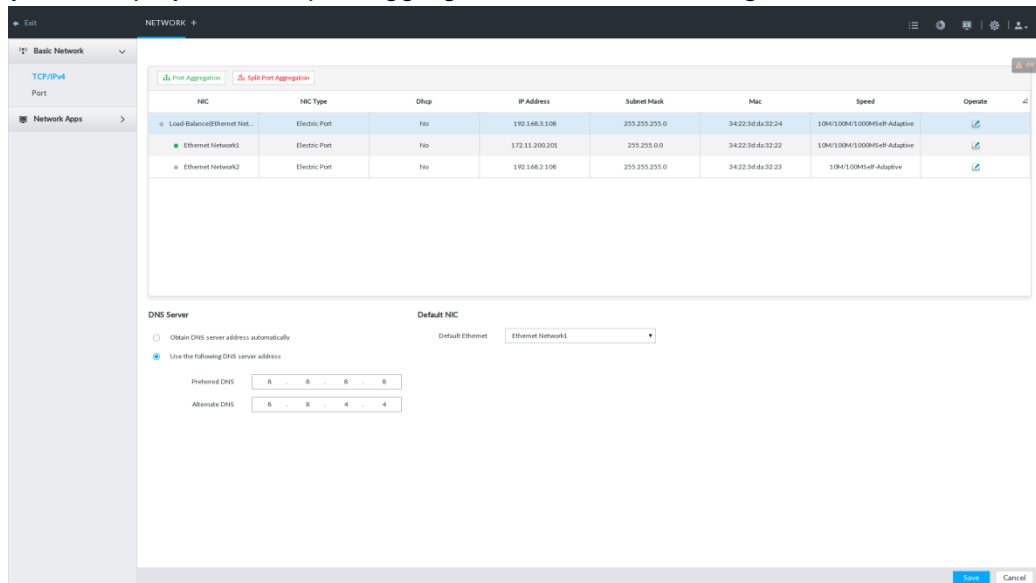

Figure 6-33

Step 3 Click Cancel port aggregation.

System pops up confirm cancel interface.

Step 4 Click OK.

System cancel bond NIC.

### Note

After cancel NIC binding, the first NIC reserve the IP address when binding, the rest NIC restore default IP addresses.

### 6.3.1.3 Set port number

It is to set device port number.

## Steps

Step 1 On Setting interface click , or click  and then select Network->Basic Network->Port.

Enter port interface.

Step 2 Set parameters.

Name	Function
TCP port	Please set according to the actual requirements. The default value is 37777. The value ranges from 1025 to 65535.
RTSP port	Please set according to the actual requirements. The default value is 554. The value ranges from 1 to 65535.
HTTP port	Please set according to the actual requirements. The default value is 80. The value ranges from 1 to 65535. If the value you set is no 80, please add the port number after the IP address when you are using browser to login the device.
HTTPS port	Please set according to the actual requirements. The default value is 443. The value ranges from 1 to 65535.
UDP port	Please set according to the actual requirements. The default value is 37778. The value ranges from 1025 to 65535.

Step 3 Click OK.

## 6.3.2 Network Applications

It is to set device network parameters so that system can connect to other devices.

### 6.3.2.1 P2P

P2P is a peer to peer technology. You can scan the QR code to download cellphone APP without DDNS service or the port mapping or installing the transmission server. After register the device to the APP, you can view the remote video, playback record file etc.



#### Note

Make sure the system has connected to the network. Otherwise, the P2P function is null.

## Steps

Step 1 On Setting interface click , or click  and then select Network->Network App->P2P.

Enter P2P interface. See Figure 6-34.



#### Note

Scan the QR code on the actual interface.

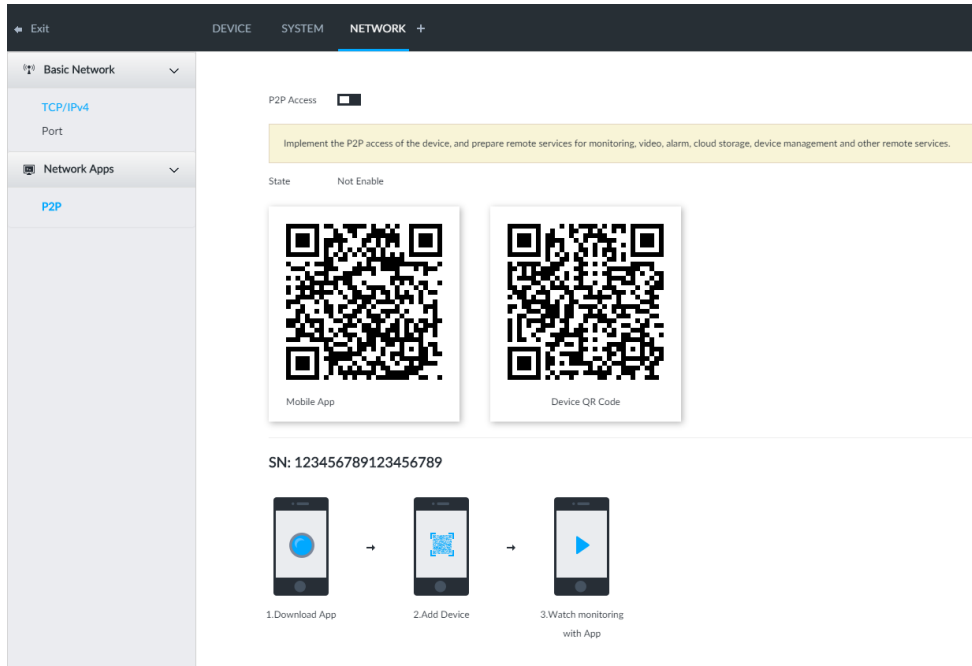



Figure 6-34

Step 2 Click  to enable P2P function.

Step 3 Click Save to save settings.

After the configuration, you can register a device to the APP to view remote video, playback record file ,etc. Refer to corresponding cellphone APP for detailed information.

 **Note**

After successfully connected to the P2P, the status displayed as Success.

### Cellphone APP

Step 1 Download and then install the cellphone APP.

1. Use an APP of scan function to scan the download cellphone APP QR code.
2. Download and install the cellphone APP according to the cellphone OS type.

Step 2 Run the cellphone APP and select Camera.

System enters real-time surveillance interface. See Figure 6-35.

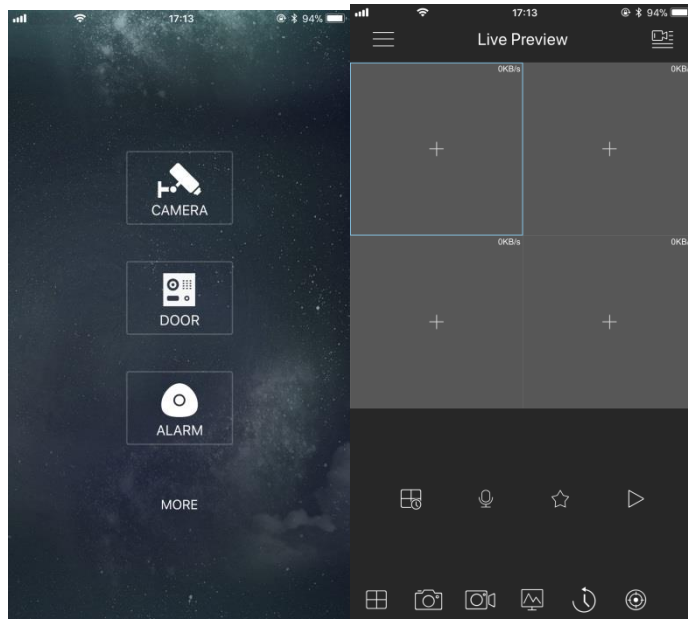

Figure 6-35

Step 3 Register a device to the cellphone APP.

**Note**

Before register the device to the APP, make sure the device you want to register has been initialized. Otherwise, you cannot properly use the device.

1. Tap and then select Device manager.

Enter Device manager interface. See Figure 6-36.

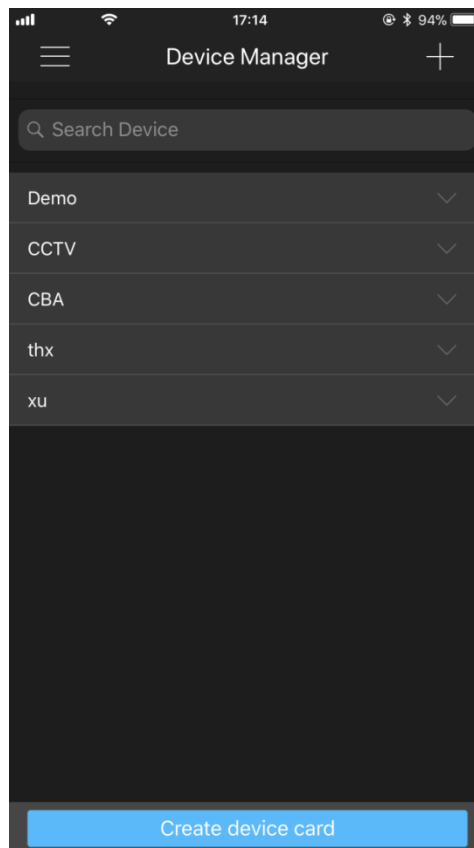

Figure 6-36

2. Tap .

Enter Add device interface. See Figure 6-37.

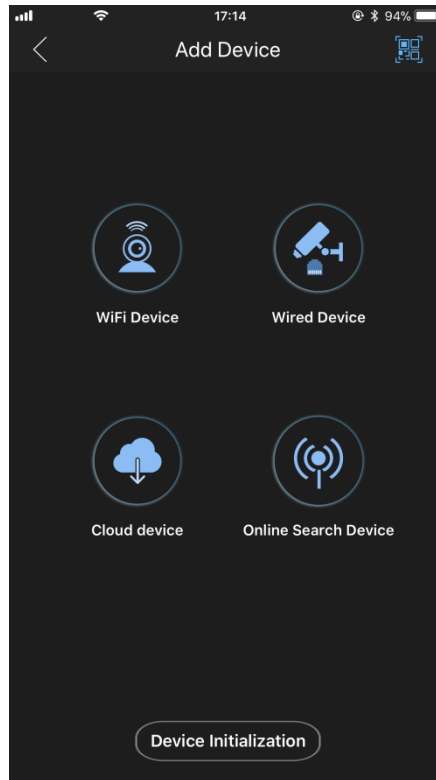

Figure 6-37

3. Select device connection type, and then follow the prompts to connect to the device. System displays device SN. See Figure 6-38.

 **Note**

You can scan the QR code to connect to the device. Follow the steps listed below:

Tap , enter the QR code of current device. Scan the QR code on Figure 6-34.

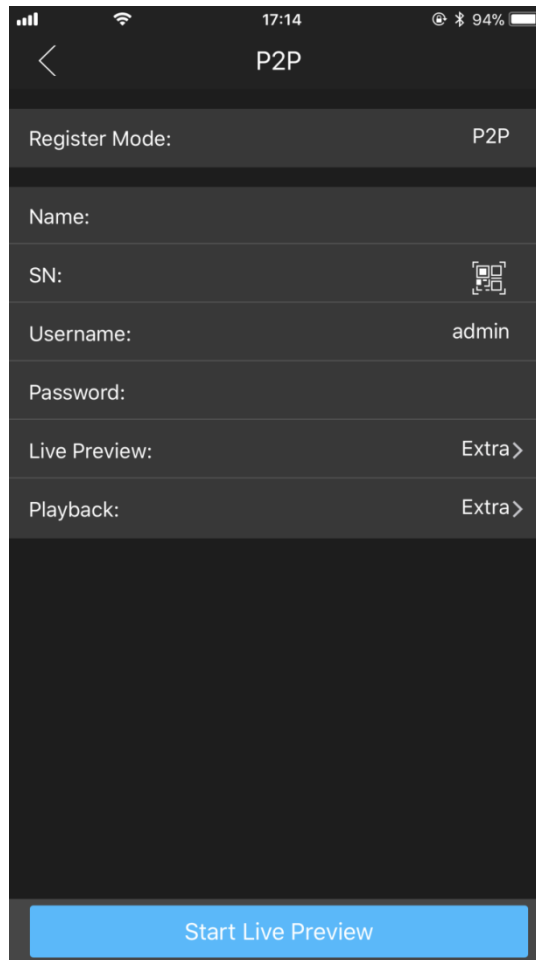

Figure 6-38

4. Set device name, user name and password according to the actual situation.

Step 4 Click Start live preview.

System begins connecting to the device. After device successfully registered to the system, you can view the real-time surveillance video.

## 6.4 Event

It is to set alarm event. When there is an alarm, system can trigger the corresponding device to generate alarm operation.

### 6.4.1 Local device

It is to set system abnormal alarm and AI detection.

#### 6.4.1.1 Abnormal alarm

It is to set alarm mode when an abnormal event occurs.

### Steps

Step 1 On Setting interface click , or click  and then select Event.

Enter Event interface. See Figure 6-39.



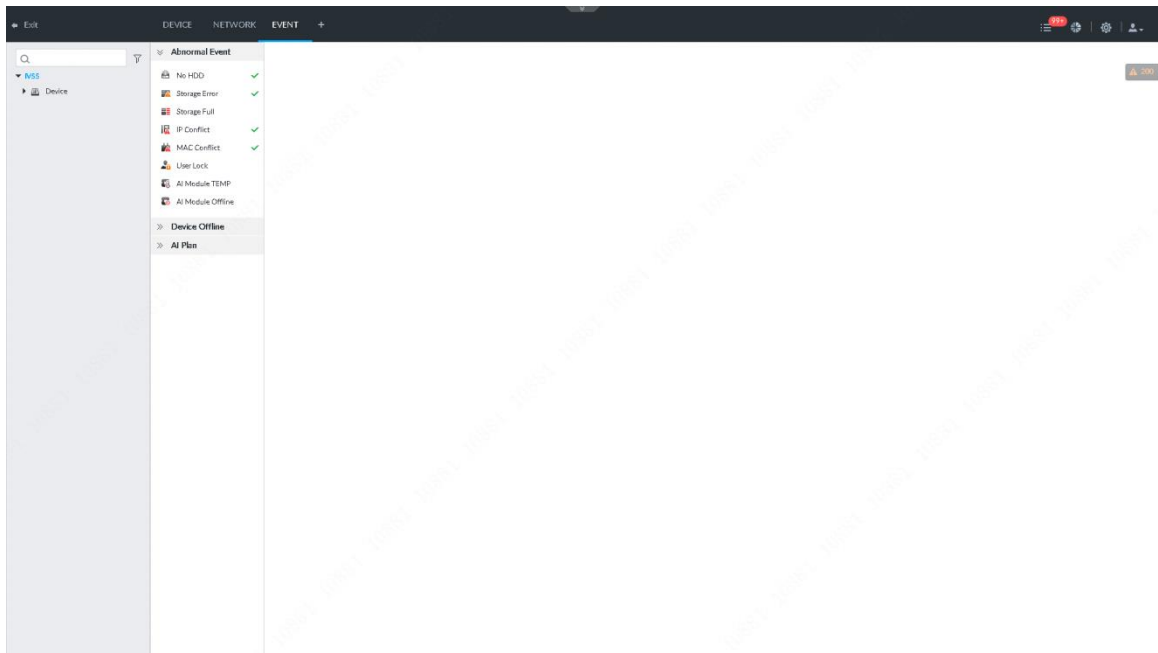

Figure 6-39

Step 2 Set parameters.

Name	Function
No HDD	System triggers an alarm when there is no HDD.
Storage error	System triggers an alarm when the HDD or the RAID has error.
Space full	System triggers an alarm when HDD space is full.
IP conflict	System triggers an alarm when its IP address conflicts with IP address of other device in the same LAN.
MAC conflict	System triggers an alarm when its MAC address conflicts with MAC address of other device in the same LAN.
Login lock	System triggers an alarm when an account login error has reached the threshold. At the same time, system locks current account. <b>Note</b> Go to the security interface to set account error threshold. Refer to chapter 6.7.3 Security protection for detailed information.
AI module temperature	When AI module temperature is higher than the specified value, system triggers an alarm.
AI module offline	When AI module and system connection is offline, system triggers an alarm.

**Note**

The enabled abnormal event has an icon .

Here we use abnormal module temperature to continue. For other event, the setting steps are similar. Refer to the actual interface for detailed information.

Step 3 Click AI module temperature tab.

Enter AI module temperature tab. See Figure 6-40.

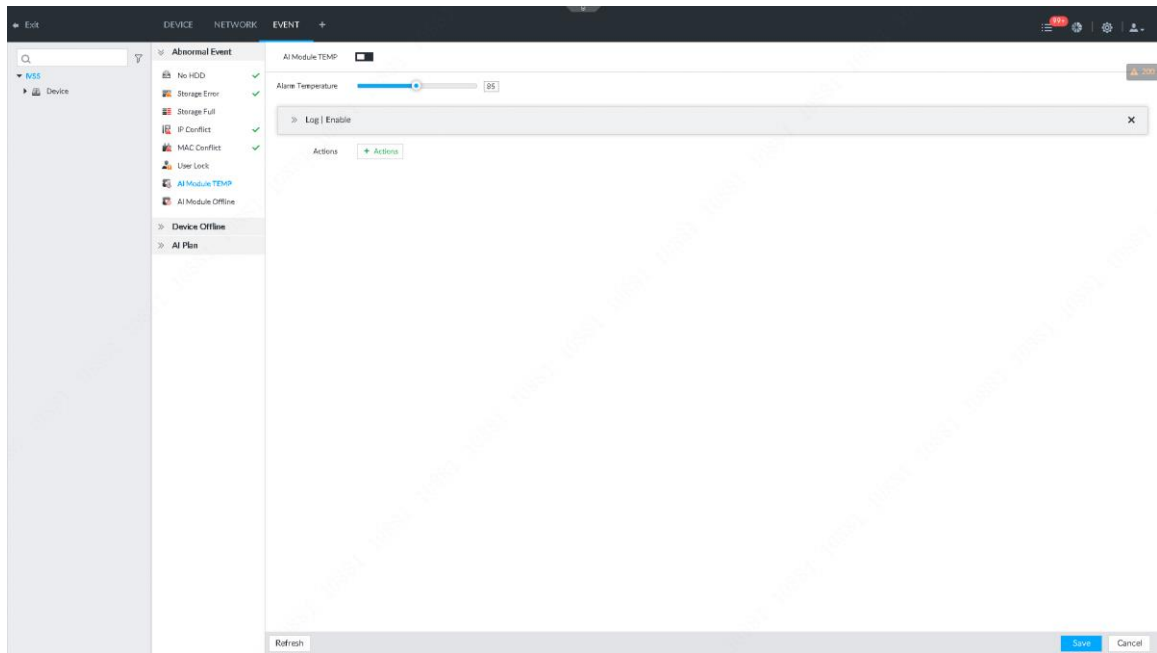



Figure 6-40

Step 4 Enable AI module temperature alarm function.

Step 5 Drag the  to set alarm temperature threshold.

 **Note**

The above step is for AI module temperature alarm only.

Step 6 Set alarm to trigger buzzer or log.

Click 

to set buzzer or log. The alarm event can trigger buzzer or log.

See Figure 6-41.

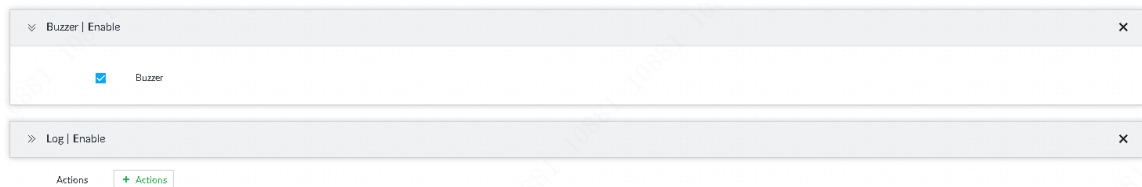

Figure 6-41

Step 7 Click OK.

### 6.4.1.2 Offline Alarm

It is to set global offline alarm strategy. If you have not set offline alarm for a specified remote device, once the remote device is disconnect from the system, system adopts global alarm strategy to trigger an alarm.

#### Steps

Step 1 On Setting interface click , or click  and then select Event.

Enter Event interface.

Step 2 From Device offline->Device offline

Enter device offline interface. See Figure 6-42.

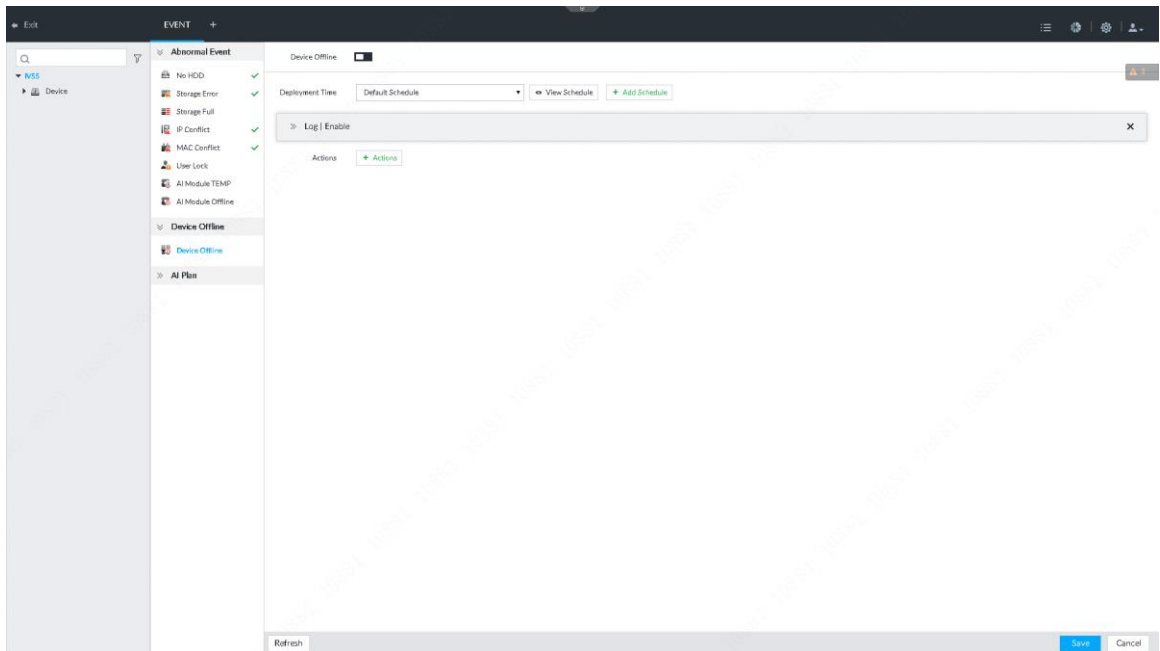

Figure 6-42

Step 3 Click  to enable device offline alarm.

Step 4 Click Arm time to select calendar from the dropdown list.

After set arm period, system can trigger corresponding operation when there is an alarm in the specified period.

- Click  to view calendar detailed information.
- If there is no calendar or the added calendar does not fit the actual situation. Click  to add calendar. Refer to chapter 6.8.4 Calendar for detailed information.

Step 5 Set alarm to trigger buzzer or log.

Click  and then select buzzer or log. See Figure 6-43.

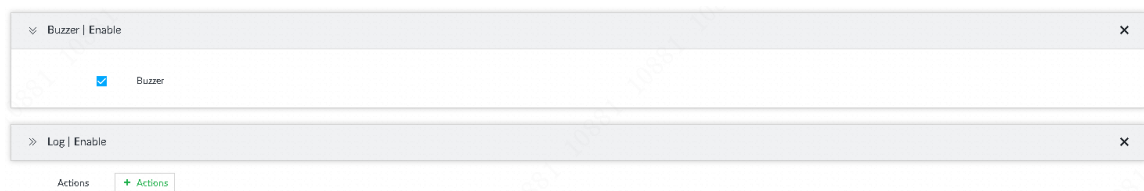

Figure 6-43

Step 6 Click Save button.

### 6.4.1.3 Global AI detection

It is to set global AI detection result display mode. If you have not set AI display settings for current remote device, the remote device adopts global AI display mode.

#### 6.4.1.3.1 View AI plan

Enter Event interface, from AI->AI->AI, enter AI interface. See Figure 6-44.

After install the AI module and the remote device supports AI detection, and you have enabled the AI

detection function, you can view the remote device channel name on the corresponding AI detection pane.

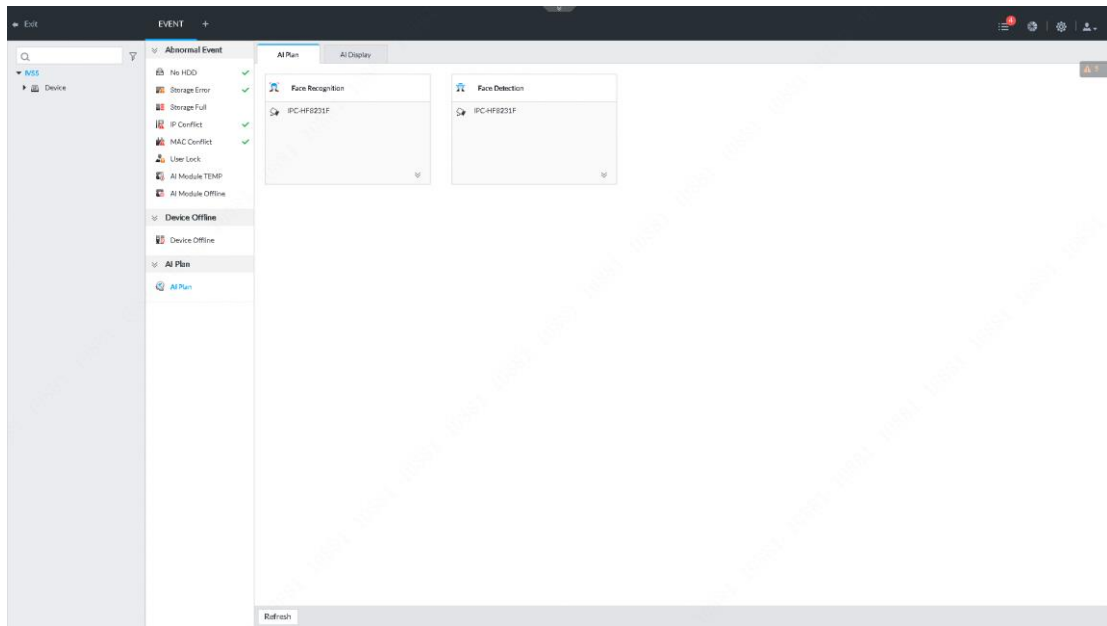

Figure 6-44

### 6.4.1.3.2 Set AI display

It is to set the features you want to view on the rule column and feature pane. On the Live interface, you can use the rule column and feature pane to view the AI detection results.

#### Steps

Step 1 On Setting interface click , or click  and then select Event.

Enter Event interface.

Step 2 From AI plan->AI plan->AI display.

Enter AI display interface. See Figure 6-45.

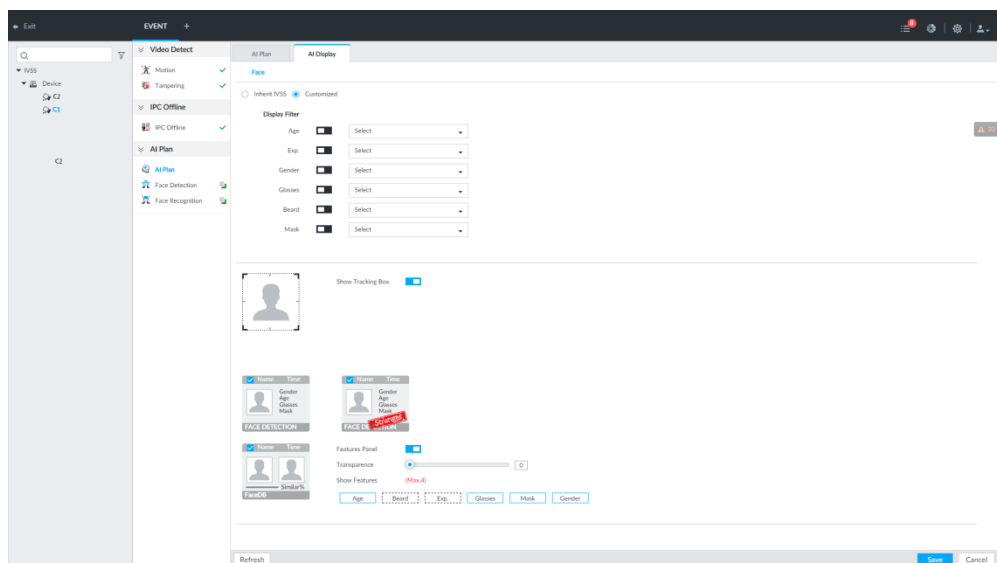

Figure 6-45

Step 3 It is to set display filter criteria.

Click  to enable the corresponding filter type and then select filter criteria from the dropdown list. For example, enable Age, and then select youth from the dropdown list. The tracking box and the features pane only display the human face of the youth age.

Step 4 Set tracking box.

1. Enable tracking box function.
2. Select feature(s) you want to display. System max supports 3 features.
3. Set the features detailed information.

Step 5 Refer to step 4 to set features.

Step 6 Click Save.

## 6.4.2 Remote Device

It is to set remote device alarm activation. System can trigger the corresponding alarm event when an alarm occurs.

### 6.4.2.1 Video Detect

Video detection function adopts the PC visual, image and graphical processing technology to analyze the video image and check there is considerable changes on the video. Once there is considerable video changes (such as there is any moving object, or the video is blurred.), system triggers corresponding alarm event.

#### 6.4.2.1.1 Motion Detect

After analyze video, system can generate a motion detect alarm when the detected moving signal reached the sensitivity you set here.

## Steps

Step 1 On Setting interface click , or click  and then select Event.

Enter Event interface.

Step 2 Select a remote device, from Video detect->Motion.

Enter Motion detect interface. See Figure 4-15.

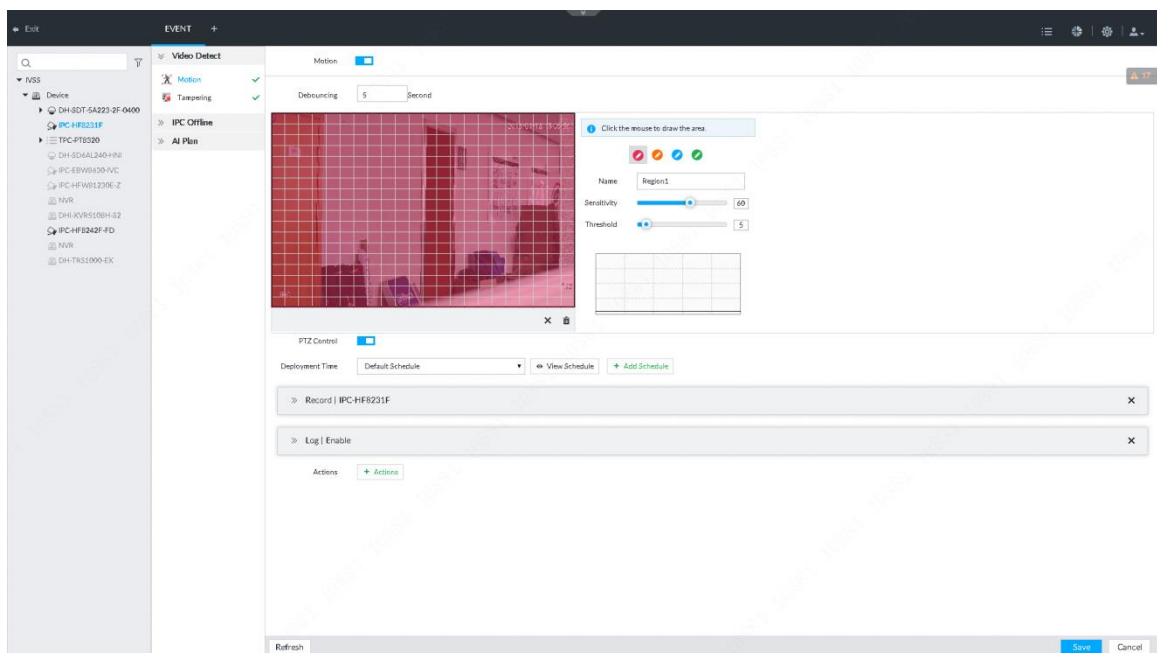





Figure 6-46

Step 3 Click  to enable video detect.

Step 4 Set parameters.

Name	Function
Anti-dither	System only records one alarm event during the anti-dither period.
Exclude PTZ control	After enable exclude PTZ control, system does not trigger an alarm when you are manually control the PTZ.  <b>Note</b> It is for PTZ camera only.

Step 5 Set motion detect zone.

1. Click motion detect zone icon .

 **Note**

System supports 4 detection zones. After the setting, once there is an alarm from either of these four zones, the remote device trigger an alarm.

2. On the surveillance video, left click mouse and use the mouse to select detection zone.

- Select the motion detect zone you drew. Click  to delete the zone.

- Click  to clear the zone you have drawn.

3. Set parameters.



Name	Function
Name	It is to set region name to distinguish different zones.
Sensitivity	The higher the sensitivity is, the easier it is to trigger an alarm, at the same time, the false alarm rate increases as well. Usually we recommend the default value.
Threshold	It is the motion detect percentage. It refers to the triggered object/detected zone. Once the detected percentage is larger than the specified threshold, system triggers alarm. For example, the threshold is 10, once the detect object occupies the 10% of the detect zone, system triggers an alarm.

 **Note**

Repeat the above steps to add more detection zones. System max supports 4 zones.

Step 6 Click deployment time and then select calendar from the dropdown list.

After set arm period, system triggers corresponding operations when there is a motion detect alarm in the specified period.

- Click  to view detailed schedule settings.
- If there is no plan or the added plan does not fit the actual requirements, click  to add a schedule. Refer to chapter 6.8.4 Calendar for detailed information.

Step 7 Set corresponding linkage event.

- Set alarm to trigger Record or Snap:

Click  and then select Record or Snap, and then select the corresponding

device to record or snap when an alarm occurs. See Figure 4-17.

**Note**

- ✧ Select Snap, system can only current channel to snap.
- ✧ Click  again, and then select Record, you can set to trigger several channels to record at the same time.

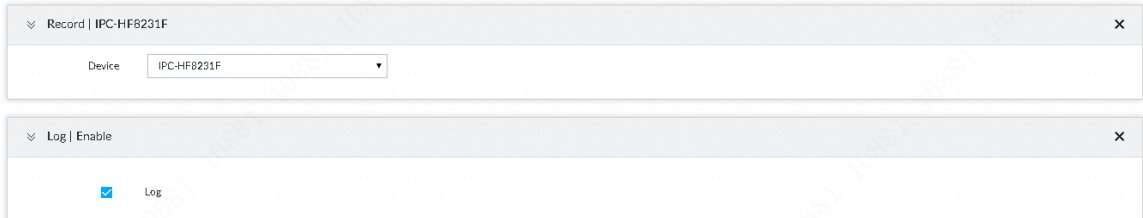



Figure 6-47

- Set alarm to trigger buzzer or log.

Click  and then select buzzer and log. It is to enable buzzer or record log file when an alarm occurs. See Figure 6-48.

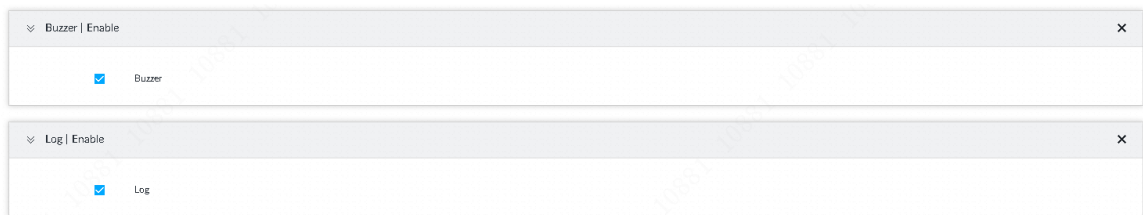

Figure 6-48

Step 8 Click Save.

#### 6.4.2.1.2 Tampering

Once an object obstacle the monitor video, which results the output video is in one-color, the system can generate an alarm.

### Steps

Step 1 On Setting interface click , or click  and then select Event.

Enter Event interface.

Step 2 Select a remote device, from Video detect->Tampering.

Enter Tampering interface

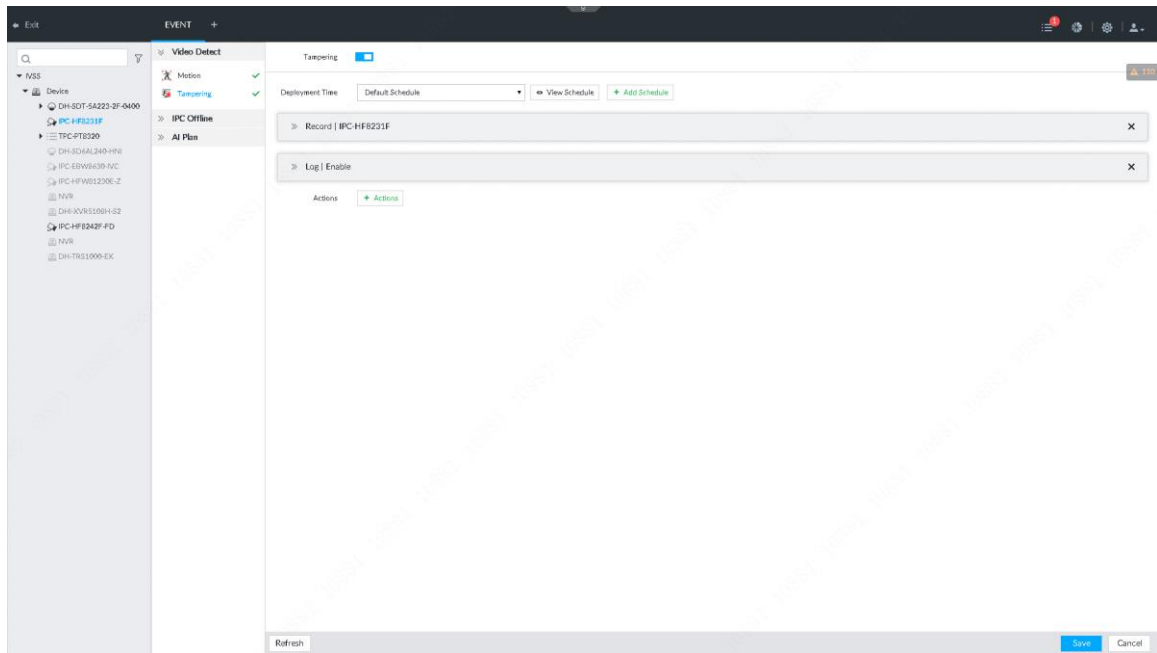

Step 3 Click to enable tampering alarm.

Step 4 Click deployment time and then select calendar from the dropdown list.

After set arm period, system triggers corresponding operations when there is a tampering alarm in the specified period.

- Click to view detailed schedule settings.
- If there is no plan or the added plan does not fit the actual requirements, click to add a schedule. Refer to chapter 6.8.4 Calendar for detailed information.

Step 5 Set corresponding linkage event.

- Set alarm to trigger Record or Snap:

Step 6 Click and then select Record or Snap, and then select the corresponding device to record or snap when an alarm occurs. See Figure 6-49.

**Note**

✧ Select Snap, system can only current channel to snap.

✧ Click again, and then select Record, you can set to trigger several channels to record at the same time.

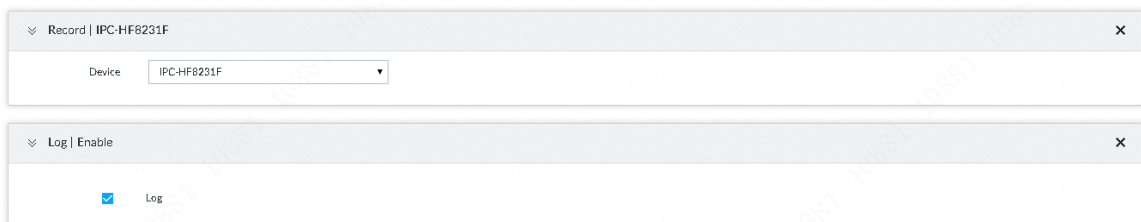



Figure 6-49

- Set alarm to trigger buzzer or log.



Click  **Actions** and then select buzzer and log. It is to enable buzzer or record log file when an alarm occurs. See Figure 6-50.

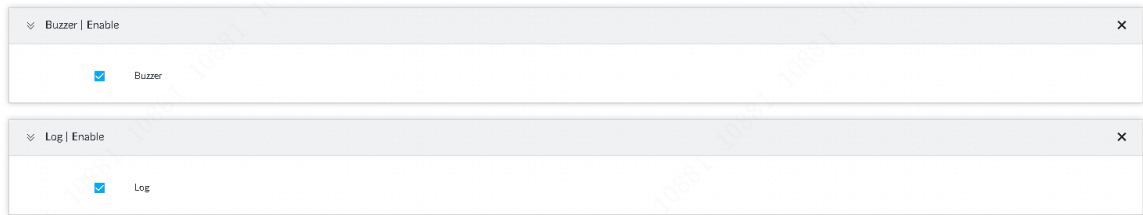



Figure 6-50

Step 9 Click Save.

### 6.4.2.2 Network alarm

When the remote device and the system connection is offline, system can trigger an alarm.

#### Steps

- Step 1 On Setting interface click , or click  and then select Event.  
Enter Event interface.
- Step 2 Select a remote device, from IPC offline->IPC offline.  
Enter IPC offline interface. See Figure 6-51.

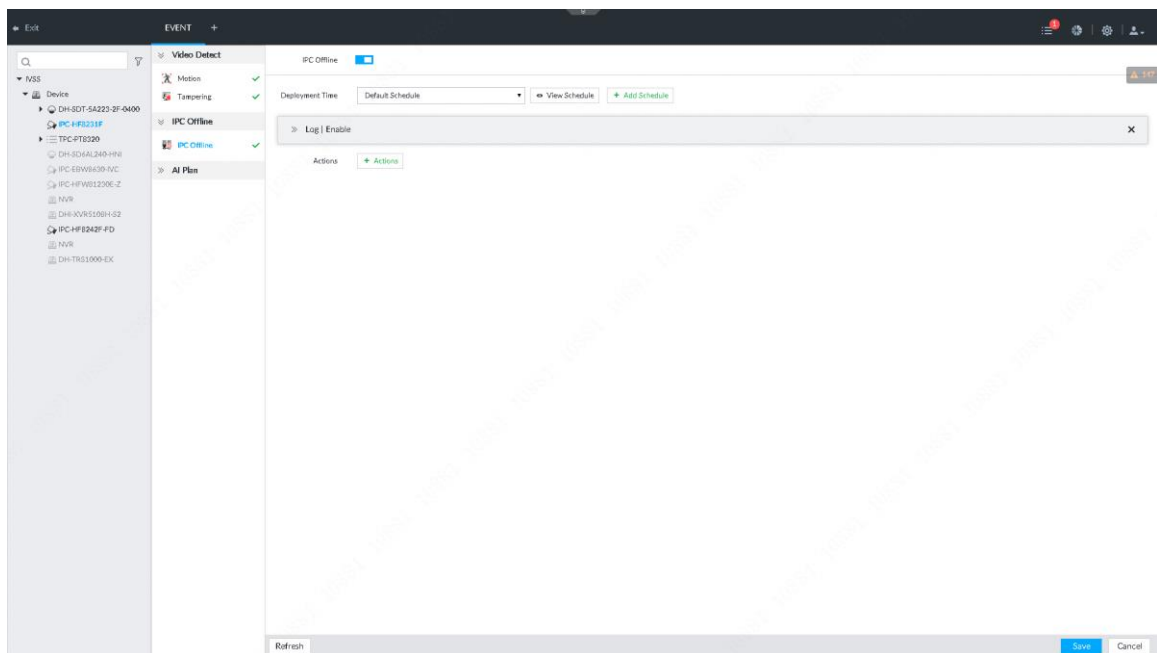



Figure 6-51

Step 3 Click  to enable network alarm.

#### Note

The network alarm is enabled by default. You can skip this step.

Step 4 Click deployment time and then select calendar from the dropdown list.  
After set arm period, system triggers corresponding operations when there is a network alarm in the specified period.

- Click  to view detailed schedule settings.
- If there is no plan or the added plan does not fit the actual requirements, click  to add a schedule. Refer to chapter 6.8.4 Calendar for detailed information.

Step 7 Set corresponding linkage event.

- Set alarm to trigger Record or Snap:

Step 8 Click  and then select Record or Snap, and then select the corresponding device to record or snap when an alarm occurs. See Figure 6-52.



**Note**

- ◇ Select Snap, system can only current channel to snap.
- ◇ Click  again, and then select Record, you can set to trigger several channels to record at the same time.

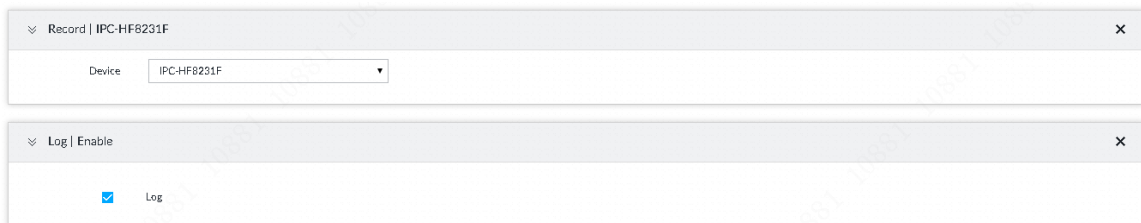



Figure 6-52

- Set alarm to trigger buzzer or log.

Click  and then select buzzer and log. It is to enable buzzer or record log file when an alarm occurs. See Figure 6-53.

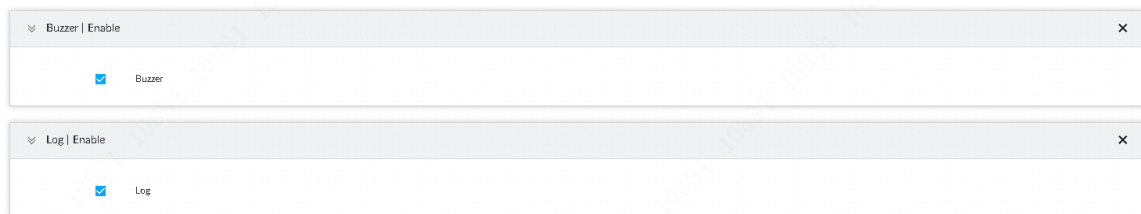

Figure 6-53

### 6.4.2.3 AI detection

AI detection is to process and analyze the video and take the key information, compare the key information with the pre-set detection rule and trigger an alarm once the detected behavior matches the detection rule.



**Note**

Make sure the remote device supports AI detection function.

#### 6.4.2.3.1 Enable AI plan

The AI detection function becomes valid once you enabled AI function.



**Note**

- Some remote devices do not support AI plan.

- The interface may vary since the remote device supports different AI functions.

## Steps

Step 1 On Setting interface click , or click  and then select Event.

Enter Event interface.

Step 2 Select a remote device, from AI plan->AI plan->AI plan.

Enter AI plan interface. See Figure 6-54.

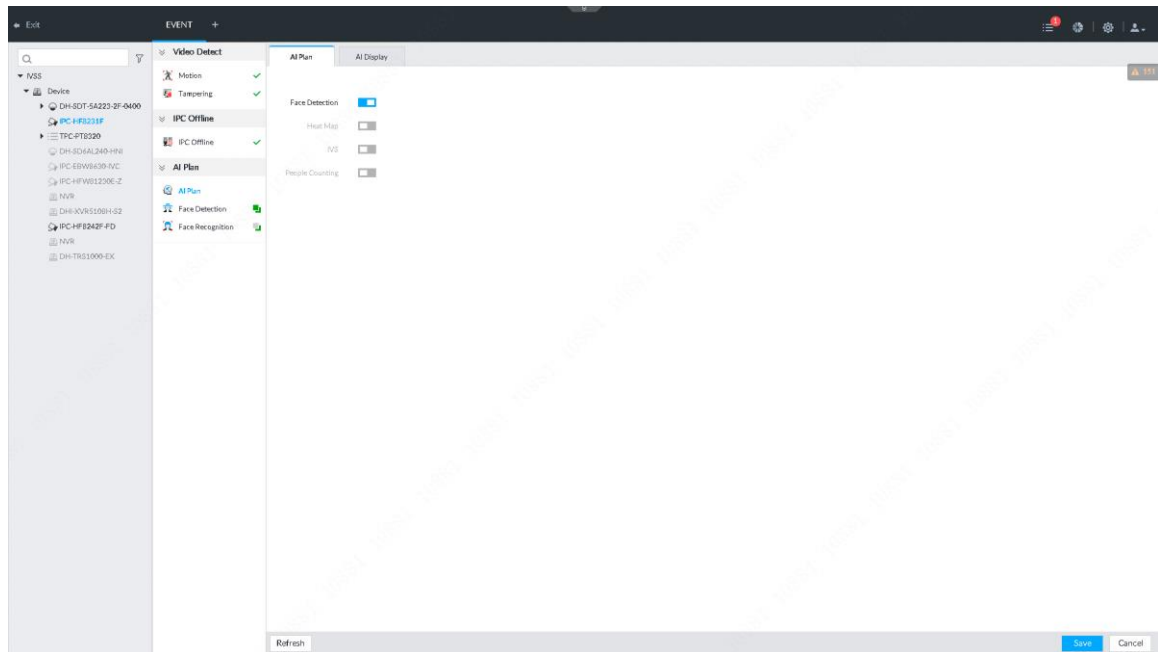



Figure 6-54

Step 3 Click  to enable AI detection plan.

Step 4 Click Save.

### 6.4.2.3.2 Set AI display

It is to set the features you want to view on the rule column and features pane. Go to the rule column and feature pane to view the AI detect results.

## Steps

Step 1 On Setting interface click , or click  and then select Event.

Enter Event interface.

Step 2 Select a remote device, from AI plan->AI plan->AI display.

Enter AI plan interface. See Figure 6-55.

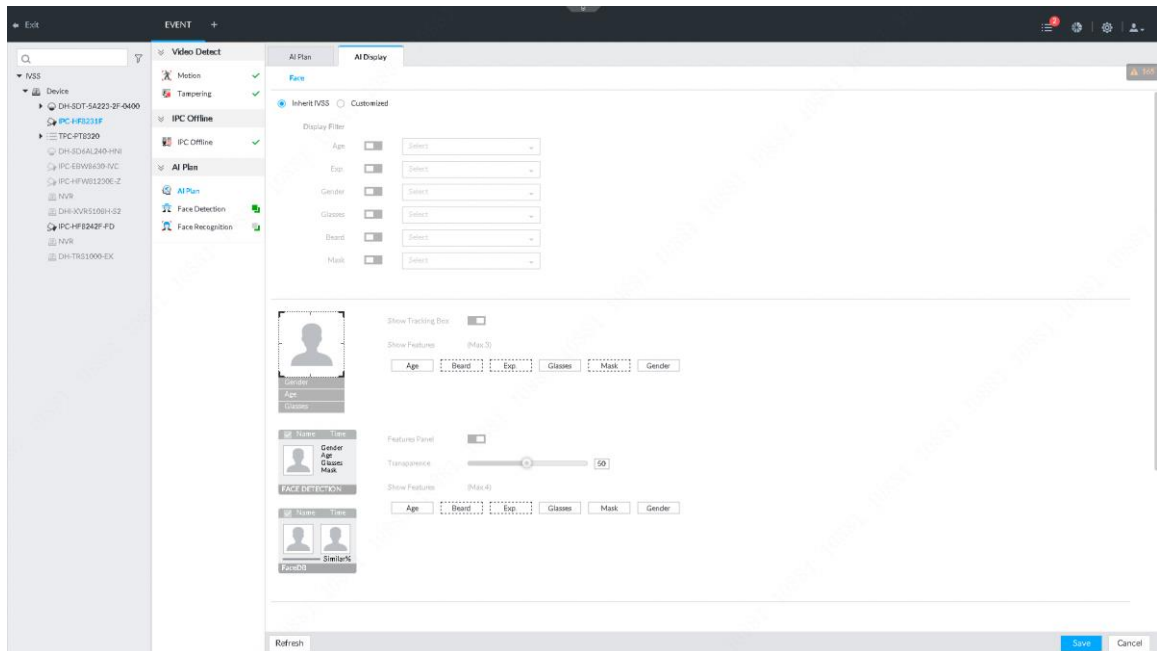

Figure 6-55

Step 3 Set use IVSS storage plan or customize.

- Inherit IVSS storage plan: The remote device adopts the device global storage plan.
- Customize: Set customized storage plan.

Step 4 It is to set display filter criteria.

Click  to enable the corresponding filter type and then select filter criteria from the dropdown list. For example, enable Age, and then select youth from the dropdown list. The tracking box and the features pane only display the human face of the youth age.

Step 5 Set tracking box.

1. Enable tracking box function.
2. Select feature(s) you want to display. System max supports 3 features.
3. Set the features detailed information.

Step 7 Refer to step 4 to set features.

Step 8 Click Save.

#### 6.4.2.3.3 Human face detection

It is to analyze the video from the remote device, and system can trigger an alarm once there is any detected human face information.

### Preparation

Please make sure you have enabled human face detection plan. Refer to chapter 6.4.2.3.1 Enable AI plan for detailed information.

### Steps

Step 1 On Setting interface click , or click  and then select Event.

Enter Event interface.

Step 2 Select a remote device, from AI plan->Face detection.

Enter AI plan interface. See Figure 6-56. The following figure is based on AI by camera.

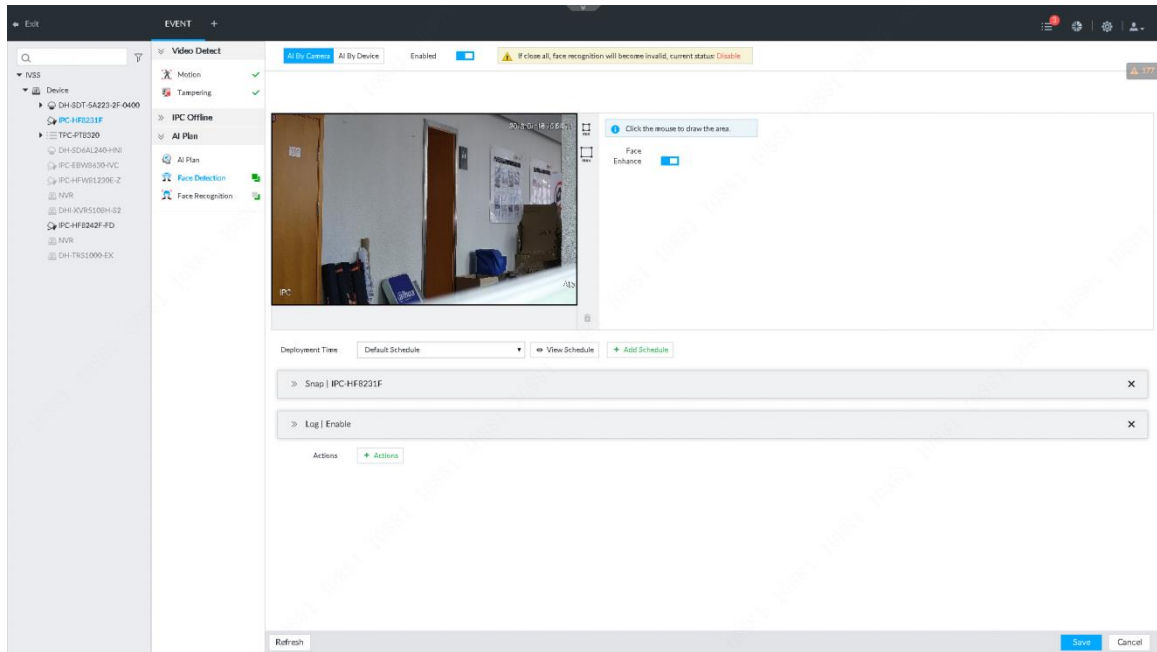



Figure 6-56

Step 3 Click AI by camera or AI by device, and then click  to enable intelligent function.

- AI by camera: The remote device supports intelligent detection such as smart network camera. The system needs to support detect and display the intelligent alarm information from the remote device and use the remote device to set intelligent detect and record playback.
- AI by device: The connected remote device does not support intelligent analysis function, but system supports intelligent detection.



Step 4 Click  to enable Face Rol.

After enable Face Rol function, system displays enhanced human face zone on the surveillance window.

 **Note**

This function is for AI by camera mode only.

Step 5 Left click mouse and draw the human face detection pane on the video window.

- Click  or  to set human face detection minimum size and maximum size. System triggers an alarm once the detected human size is not larger than the maximum size or smaller than the minimum size.
- Select a human face detection zone you have drawn and then click  to delete.

Step 6 Click arm time and then select calendar from the dropdown list.

After set arm period, system triggers corresponding operations when there is an alarm in the specified period.

- Click  to view detailed schedule settings.
- If there is no plan or the added plan does not fit the actual requirements, click

+ Add Schedule

to add a schedule. Refer to chapter 6.8.4 Calendar for detailed information.

Step 7 Set corresponding linkage event.

- Set alarm to trigger Record or Snap:

Click and then select Record or Snap, and then select the corresponding device to record or snap when an alarm occurs. See Figure 6-52.

**Note**

- ◇ Select Snap, system can only current channel to snap.
- ◇ Click again, and then select Record, you can set to trigger several channels to record at the same time.

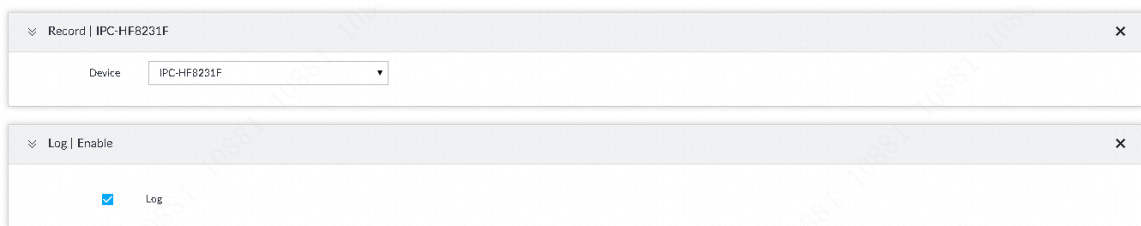

Figure 6-57

- Set alarm to trigger buzzer or log.

Click and then select buzzer and log. It is to enable buzzer or record log file when an alarm occurs. See Figure 6-53.

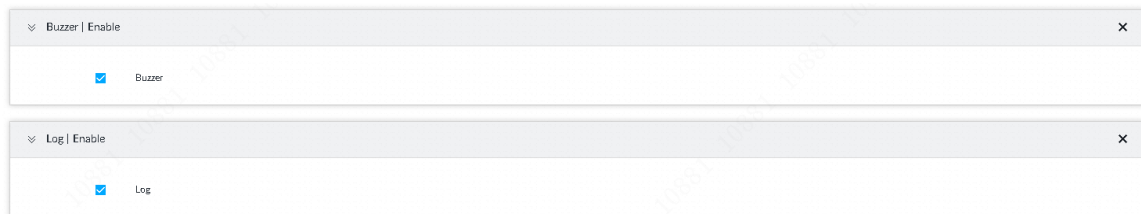

Figure 6-58

Step 8 Click Save.



#### 6.4.2.3.4 Human face comparison

It is to compare the human face detected image with the image on the human face database. Once similarity is equal to or more than the specified value, system can trigger an alarm.

### Preparation

- Make sure you have added the human face database. Refer to chapter 6.4.2.3.3 Configuring face database for detailed information.
- If you want to use system to implement human face comparison, please enable human face detection function. Refer to chapter 6.4.2.3.3 Human face detection for detailed information.

### Steps

- Step 1 On Setting interface click , or click  and then select Event.  
Enter Event interface.
- Step 2 Select a remote device, from AI plan->Face recognition.  
Enter face recognition interface. See Figure 6-59.

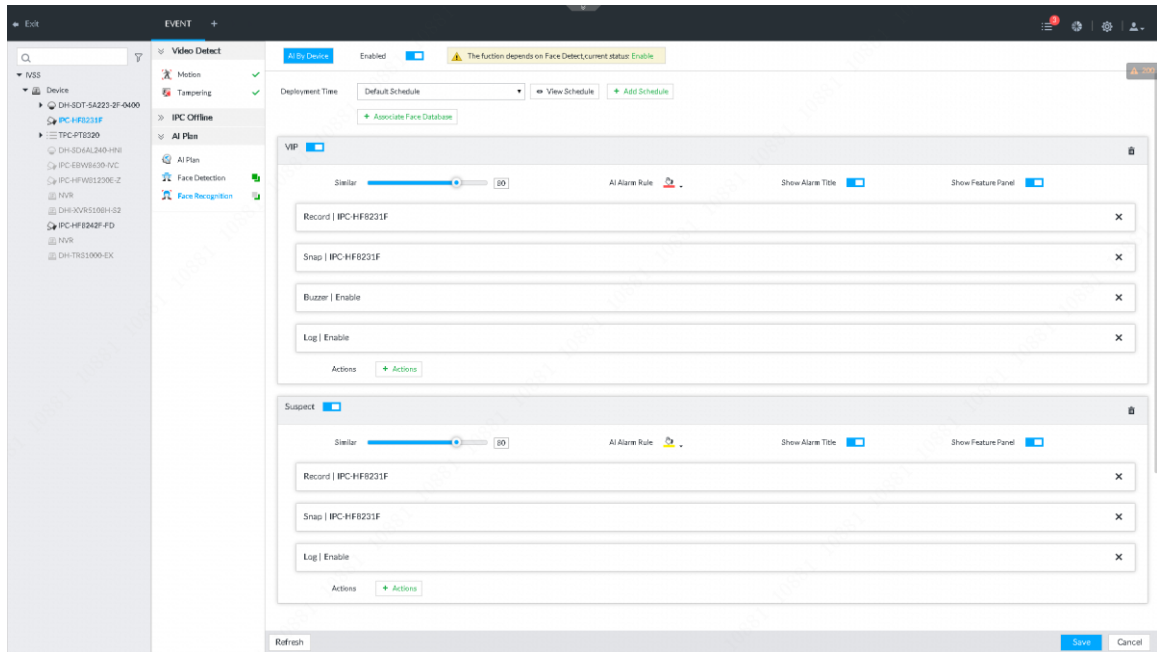





Figure 6-59

- Step 3 Click AI by camera or AI by device, and then click  to enable intelligent function.
- AI by camera: The remote device supports intelligent detection such as smart network camera. The system needs to support detect and display the intelligent alarm information from the remote device and use the remote device to set intelligent detect and record playback.
  - AI by device: The remote device does not support intelligent analysis function, but system supports intelligent detection.
- Step 4 Click arm time and then select calendar from the dropdown list.  
After set arm period, system triggers corresponding operations when there is an motion detect alarm in the specified period.
- Click  to view detailed schedule settings.
  - If there is no plan or the added plan does not fit the actual requirements, click  to add a schedule. Refer to chapter 6.8.4 Calendar for detailed information.
- Step 5 Set stranger mode.

It is to enable stranger mode. Once the human face comparison similarity is lower than the specified value, system triggers an alarm.

 **Note**

If the stranger mode is disabled, the preview interface displays human face detection pane once the human face comparison similarity is lower than the specified value.

1. Click  to enable stranger mode.

System displays stranger mode interface. See Figure 6-60.

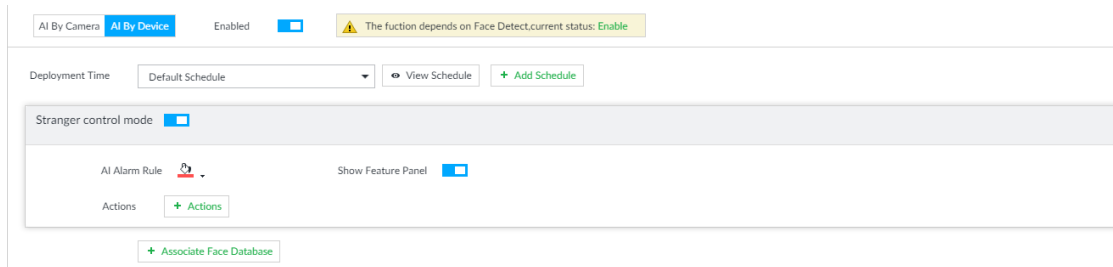



Figure 6-60

2. Set parameters.

Name	Function
AI alarm rule	Click the color zone to set alarm rule box color.
Features pane	Check the box to enable features pane function. System displays stranger pane once there is an alarm.

3. Set corresponding linkage event.

- Set alarm to trigger Record or Snap:

Click  and then select Record or Snap, and then select the corresponding device to record or snap when an alarm occurs. See Figure 6-61.

**Note**

- ✧ Select Snap, system can only current channel to snap.

Click  again, and then select Record, you can set to trigger several channels to record at the same time.

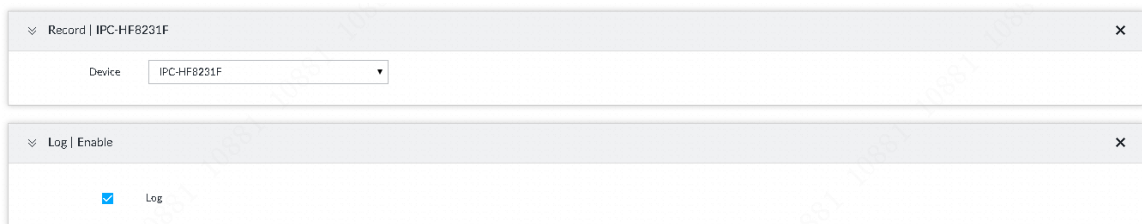



Figure 6-61

- Set alarm to trigger buzzer or log.

Click  and then select buzzer and log. It is to enable buzzer or record log file when an alarm occurs. See Figure 6-62.

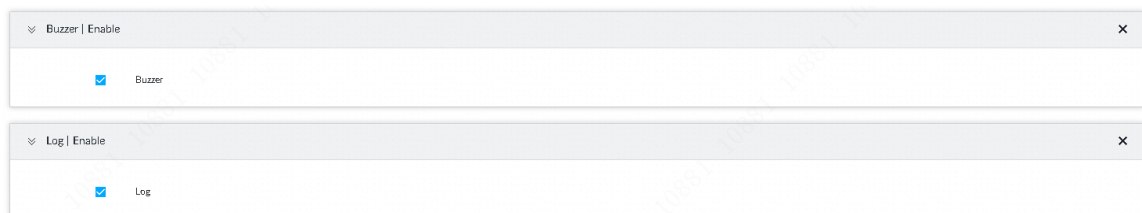

Figure 6-62



Step 6 Set triggered human face database.

 **Note**

- Before you use AI by camera function, please go to the remote device to set human face database. At that interface, please set alarm activation event.

- Repeat the step to trigger several human databases at the same time.

1. Click trigger face database, and then select the triggered human face database. Enable trigger human face database function.
2. Set parameters.

Name	Function
Similarity	It is to set human face similarity. System compares the human face with the image on the human face database, system triggers an alarm once the similarity reaches threshold you set here.
AI alarm rule	Click the color zone to set alarm rule box color.
Features pane	Check the box to enable features pane function. System displays features pane once there is an alarm.

3. Refer to 3 in step 5 to set alarm linkage events.



Step 10 Click Save.

## 6.5 Storage

Storage management is to manage the storage resources (such as record file) and storage space. It is easy for you to use and enhance storage space usage efficiency.

### 6.5.1 Physical HDD

The physical HDD refers to the HDD installed on the system. In this interface, you can view HDD space (free space/total space), temperature (centigrade/Fahrenheit), HDD information ,etc.

On Setting interface click , or click  and then select Storage. From Storage->HDD, enter HDD interface. See Figure 6-63.

 **Note**

- There is a corresponding icon near the HDD name after you created the RAID and hotspare HDD.

 : It is the RAID HDD.

 : Global hotspare HDD.

 : Invalid private hotspare HDD.

- Slight difference may be found on the user interface.

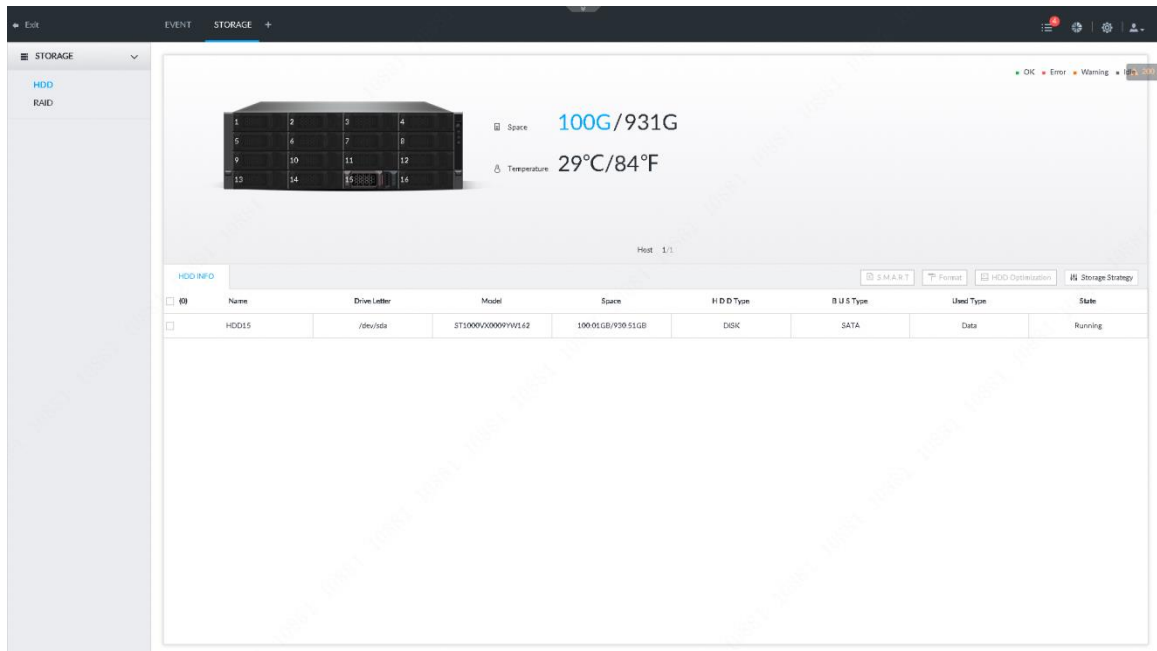

Figure 6-63

### 6.5.1.1 View S.M.A.R.T

S.M.A.R.T is so called Self-Monitoring Analysis and Reporting Technology. It is a technical standard to check HDD drive status and report potential problems. System monitors the HDD running status and check with the specified safety value. Once the monitor status is higher than the specified value, system displays alarm information to guarantee HDD data security.



**Note**

Check one HDD to view S.M.A.R.T information at one time.

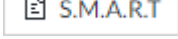
Enter HDD interface and then select HDD, click , enter S.M.A.R.T interface. See Figure 6-64.

Check the HDD status is OK or not. If there is any problem, please fix in time.

Sn	Note	Value	Worst	Boundary	Original Data	State
1	Read Error Rate	117	99	6	135185072	Better
3	Spin Up Time	97	97	0	0	Better
4	Start/Stop Co...	100	100	20	780	Better
5	Reallocated S...	100	100	36	0	Better
7	Seek Error Rate	67	60	30	17203264542	Better
9	Power On Ho...	98	98	0	2426	Better
10	Spin-up Retry...	100	100	97	0	Better
12	Power On/Of...	100	100	20	752	Better
184	End-to-End F...	100	100	99	0	Better

Figure 6-64

### 6.5.1.2 Set storage strategy

It is to set record strategy when HDD space is full.

#### Steps

Step 1 On Setting interface click , or click  and then select HDD.  
Enter HDD interface.

Step 2 Click  Storage Strategy.  
Enter Set storage strategy interface. See Figure 6-65.

Figure 6-65

Step 3 Set storage strategy.

- Overwrite: When HDD free space is less than 50G or it is less than 1% of the total space, which one it is larger, system stops recording and begins overwriting the oldest record file.

- Stop: When HDD free space is less than 50G or it is less than 1% of the total space, whichever one is larger, system stops recording.

Step 4 Click Save.

### 6.5.1.3 HDD Cleanup



After the HDD is working for a period time, since it is repeatedly written or deleted files, the files are saved on the discontinued physical position on the HDD. It may result in too much HDD fragmentation and slow the HDD access speed. The HDD cleanup is to organize the fragmentation files on the HDD and make the fragmentation files become the continue files. It can enhance HDD whole performance and running speed.



CAUTION

HDD Cleanup may result in some record file loss. Be careful!

### Steps

Step 1 On Setting interface click , or click  and then select HDD.  
Enter HDD interface.

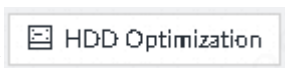
Step 2 Select one and more HDD(s) and then click .  
Enter Cleanup Strategy. See Figure 6-66.

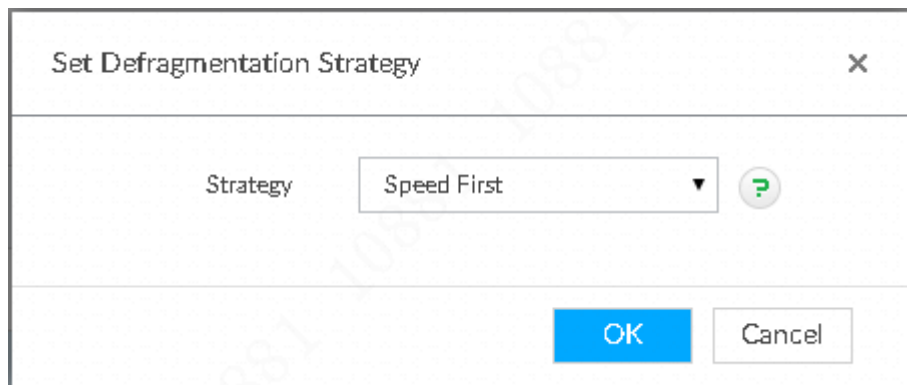

Figure 6-66

Step 3 Set HDD Cleanup strategy.

- Speed first: Cleanup HDD at fast speed. The max speed is 100M/s.
- Business first: System automatically adjusts HDD Cleanup speed according to current business load status.

Step 4 Click OK button.

Enter following prompt interface. See Figure 6-67.

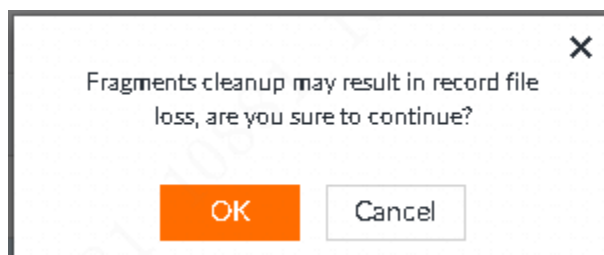

Figure 6-67

Step 5 Click OK.

System begins clearing up HDD. Now the HDD status displays as “Cleanup”. After the HDD Cleanup, status becomes “Running”.

#### 6.5.1.4 Format HDD



#### CAUTION

The format HDD operation is going to clear all data on the HDD. Be careful!

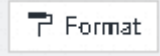
Enter HDD interface, select one or more HDD(s), click  Format . It is to format the selected HDD.

#### 6.5.1.5 Repair file system

Once you cannot mount the HDD or you cannot properly use the HDD, you can try to use repair file system function to fix.

Enter HDD interface, select one or more HDD(s) you cannot mount, click Repair file system, you can repair the selected file system of the corresponding HDD(s). The repaired HDD can work properly or to be mounted.

### 6.5.2 RAID

RAID (redundant array of independent disks) is a data storage virtualization technology that combines multiple physical HDD components into a single logical unit for the purposes of data redundancy, performance improvement, or both.



#### Note

- Right now, device supports RAID 0, RAID 1, RAID 5, RAID 6, and RAID 10. Refer to Appendix RAID for detailed information.
- It is recommended to use enterprise HDD when you are creating RAID. It is recommended to use surveillance HDD when you are surveillance on one HDD.

#### 6.5.2.1 Create RAID

RAID has different levels such as RAID 5, RAID 6 ,etc. Different RAID level has different data protection, data availability and performance. Please create RAID according to your actual requirements.



#### CAUTION

Creating RAID operation is going to clear all data on these HDD. Be careful!

- **Shortcut menu to create RAID**

System supports one click to create RAID 5. When the device all HDD slots are full, refer to the following table to use shortcut menu to create RAID 5.



#### Note

In the following table, the number (such as 9, 5, and 3) in the creation strategy refers to the HDD amount in a RAID 5, 1 is the hotspare HDD. For example, when there are 24 HDDs, the creation strategy is 9+9+5+1, it means created 3 RAID 5 groups and one global spare HDD. Among the three RAID 5 groups, the HDD amount is 9, 9, 5 respectively.

HDD Amount	Creation Strategy
24	9+9+5+1
16	5+5+5+1
12	5+5+1+1

HDD Amount	Creation Strategy
8	5+3

## Steps

Step 1 On Setting interface click , or click  and then select Storage->RAID->RAID. Enter HDD interface. See Figure 6-68.

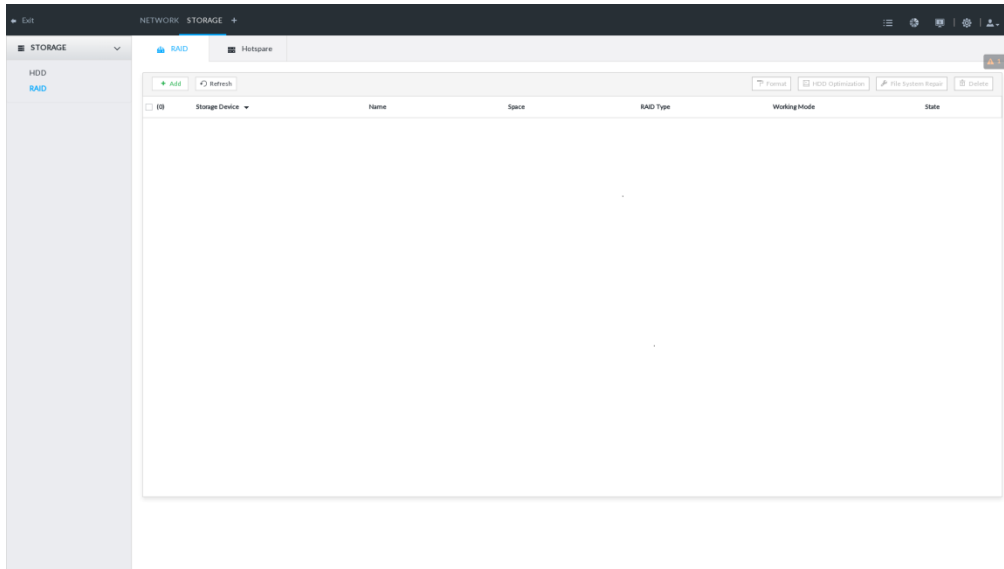

Figure 6-68

Step 1 Click Add. Enter Create RAID interface. See Figure 6-69.

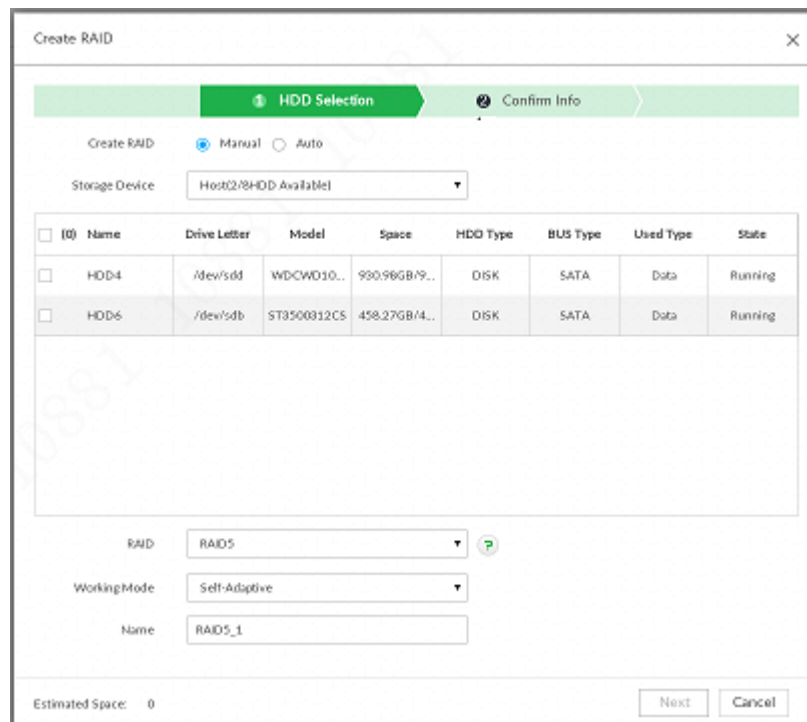

Figure 6-69

Step 2 Set RAID parameters.

Select RAID creation type according to actual situation. It includes Manual RAID and one click RAID.

- Manual RAID: System creates a specified RAID type according to the selected HDD amount.
  1. Select Manual RAID.
  2. Select HDD you want to use.
  3. Set parameters.

Name	Function
Storage device	It is to select storage device of the HDD and select the HDD you want to add to the RAID. <b>Note</b> The different RAID type needs different HDD amount. Please refer to the actual situation.
RAID	Select a RAID type you want to create.
Working mode	It is to set RAID resources allocation mode. The default setup is self-adaptive. Self-adaptive means the system can automatically adjust RAID synchronization speed according to current business load. When there is no external business, the synchronization speed is at high speed. When there is external business, the synchronization speed is at low speed.
Name	It is to set RAID name.

- One click RAID: System creates RAID 5 according to the HDD amount.  
 Select one click RAID, system enters one click RAID interface. See Figure 6-70.

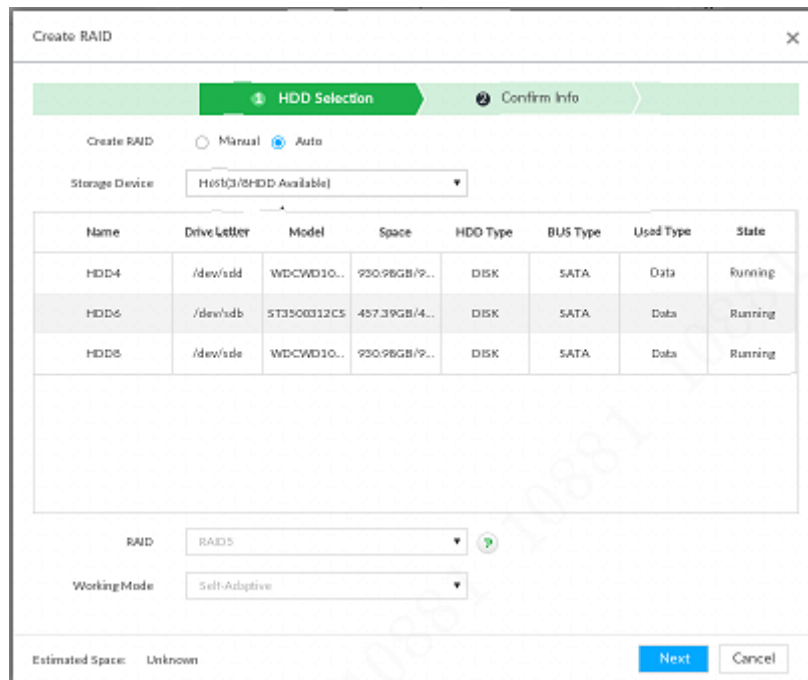

Figure 6-70

Step 3 Click Next.

Enter confirm information interface. See Figure 6-71 or Figure 6-72.

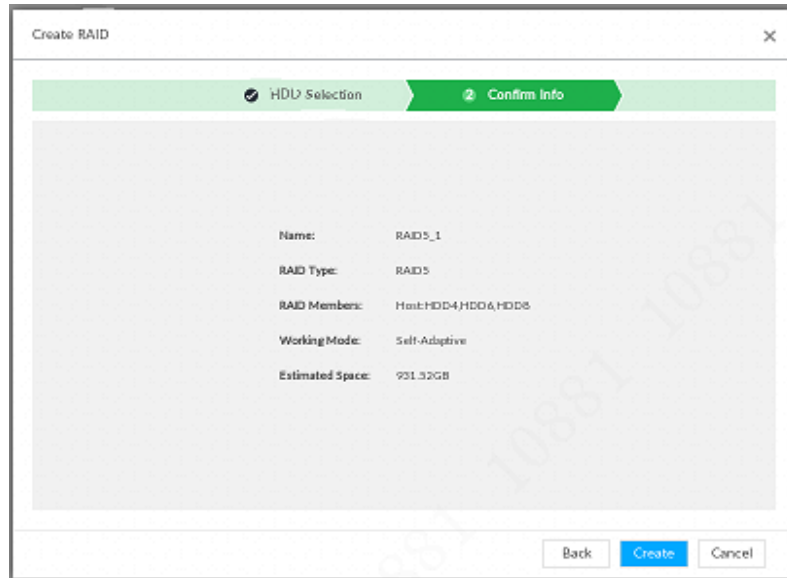

Figure 6-71

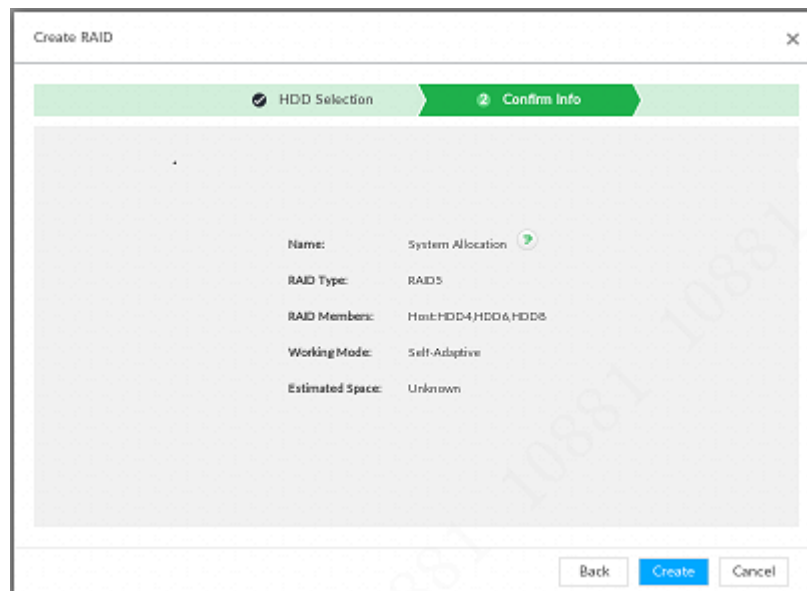

Figure 6-72

Step 4 Confirm information.

**Note**

If the input information is wrong, click Back to set RAID parameters again. Refer to step 3.

Step 5 Click Create.

System begins create RAID. It displays RAID information after creation. See Figure 6-73.



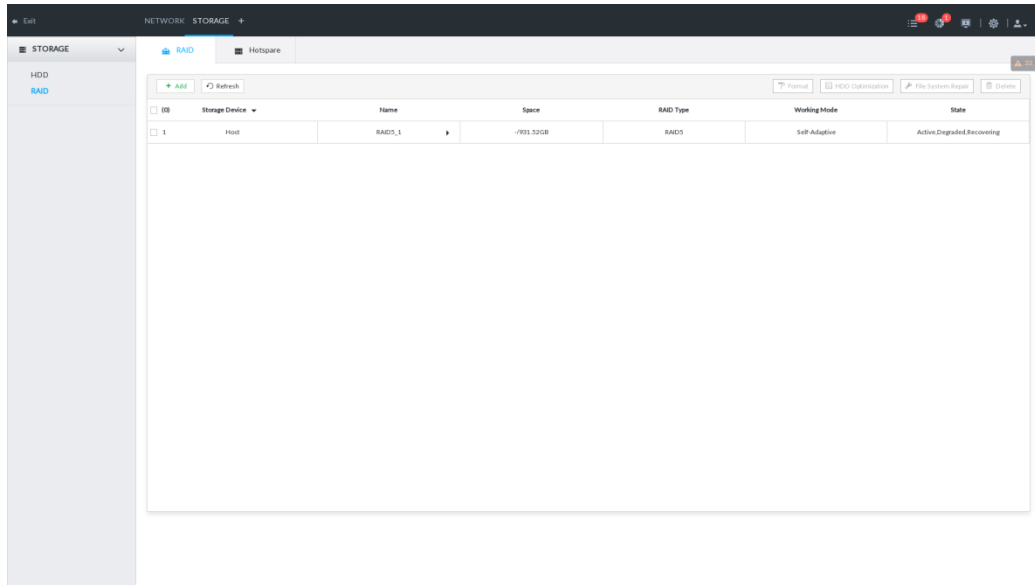

Figure 6-73

- Click the at the right side of the RAID name to open the RAID HDD list. It is to view RAID HDD space, status ,etc.
- Click , it displays detailed information. See Figure 6-74. It is to view RAID detailed information.

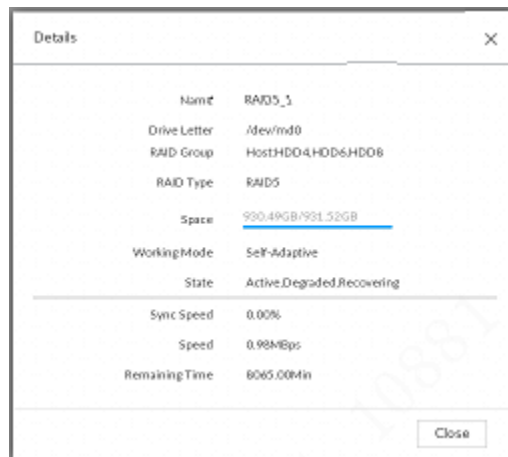

Figure 6-74

### 6.5.2.2 HDD Cleanup

Enter RAID interface and then select one or more RAID, click HDD Cleanup. It is to Cleanup HDD and files. Refer to chapter 6.5.1.3 HDD Cleanup for detailed information.

### 6.5.2.3 Delete RAID



#### CAUTION

Deleting RAID is to clear all data on the RAID and cancel the RAID group. Please be careful.

Enter RAID interface, select one and more RAID groups. Click Delete to delete the selected RAID.

### 6.5.2.4 Format RAID

Deleting RAID is to clear all data on the RAID and cancel the RAID group. Please be careful.

Enter RAID interface, select one and more RAID groups. Click Format to format the selected RAID.

### 6.5.2.5 Repair file system

Once you cannot mount the RAID or you cannot properly use the RAID, you can try to use repair file system function to fix.

Enter RAID interface, select one or more RAID(s) you cannot mount, click Repair file system, you can repair the selected file system of the corresponding RAID(s). The repaired RAID can work properly or to be mounted.

### 6.5.2.6 Create Hotspare HDD

When a HDD of the RAID group is malfunction or has a problem, the hotspare HDD can replace the malfunction HDD. There is no risk of data loss and it can guarantee storage system reliability.

## Steps

Step 1 On Setting interface click , or click  and then select Storage->RAID->RAID.

Enter HDD interface. See Figure 6-75.

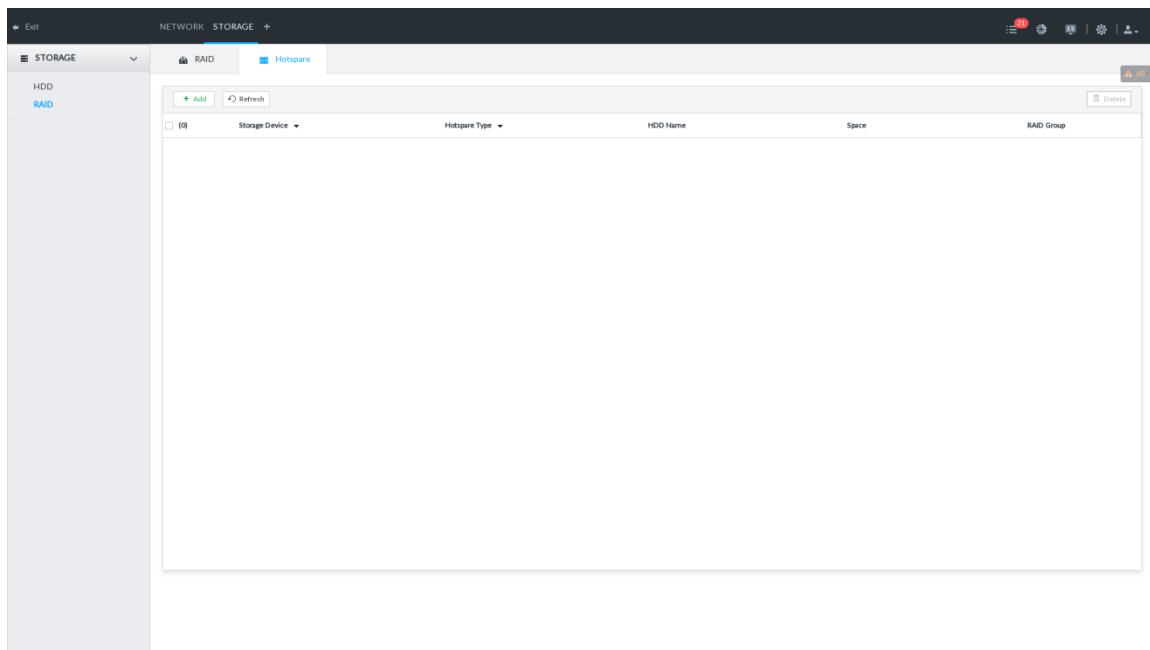

Figure 6-75

Step 2 Click Add.

Enter add hotspare interface. See Figure 6-76 or See Figure 6-77.

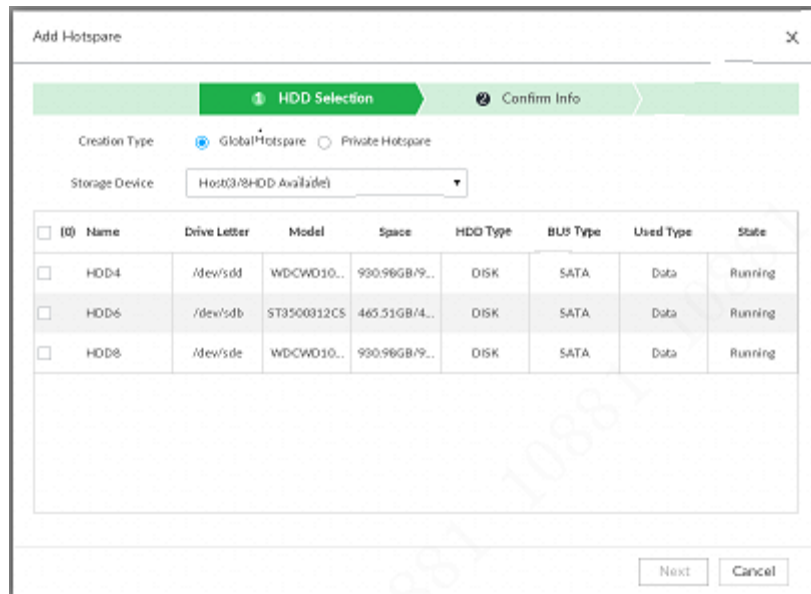

Figure 6-76

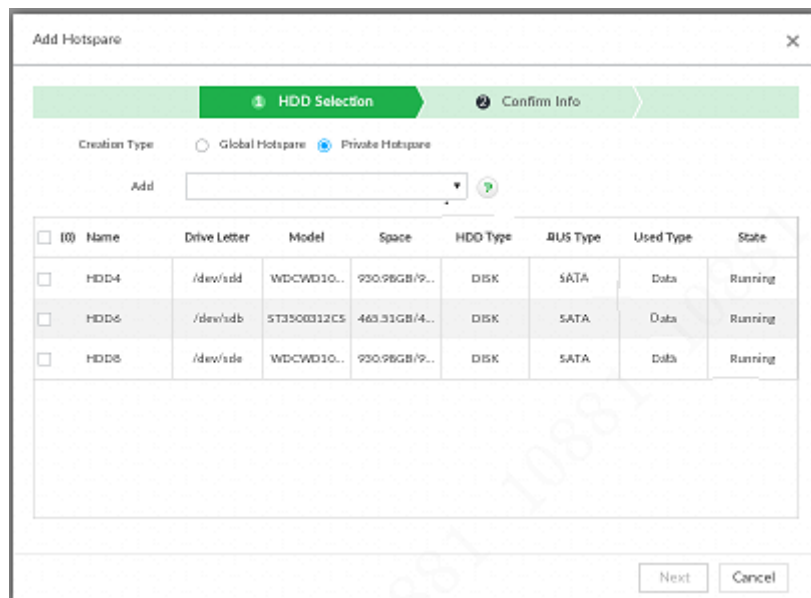

Figure 6-77

Step 3 Select hotspare HDD type.

- Global HDD: It is to create a global HDD. It is not a hotspare HDD for a specified RAID group.
- Private HDD: Select private HDD and add it to a RAID group. The private hotspare HDD is for a specified RAID group.

Step 4 Select one or more HDD(s) and then click Next.

Enter confirm information interface. See Figure 6-78.

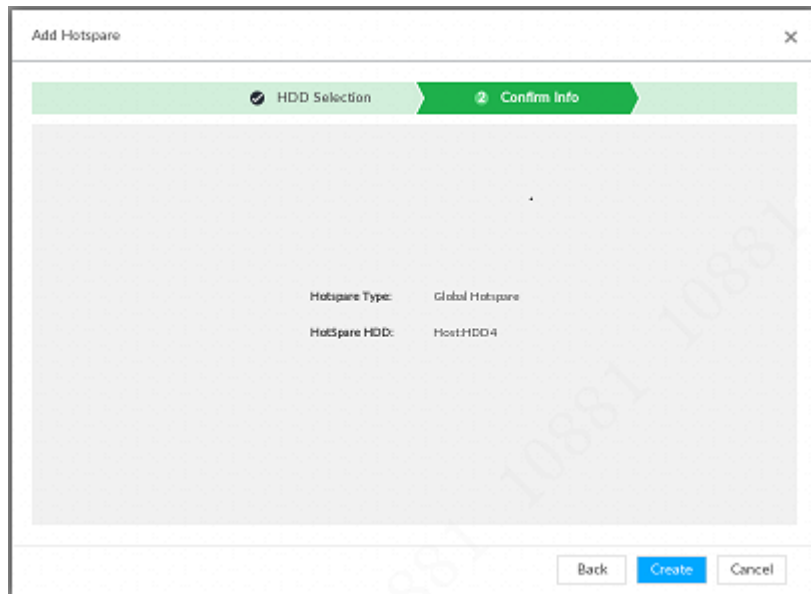

Figure 6-78

Step 5 Confirm information.

**Note**

Click Back to select hotspare HDD(s) again if you want to change settings. Refer to Step 3.

Step 6 Click Create to save settings.

System displays the added hotspare HDD information. See Figure 6-79.

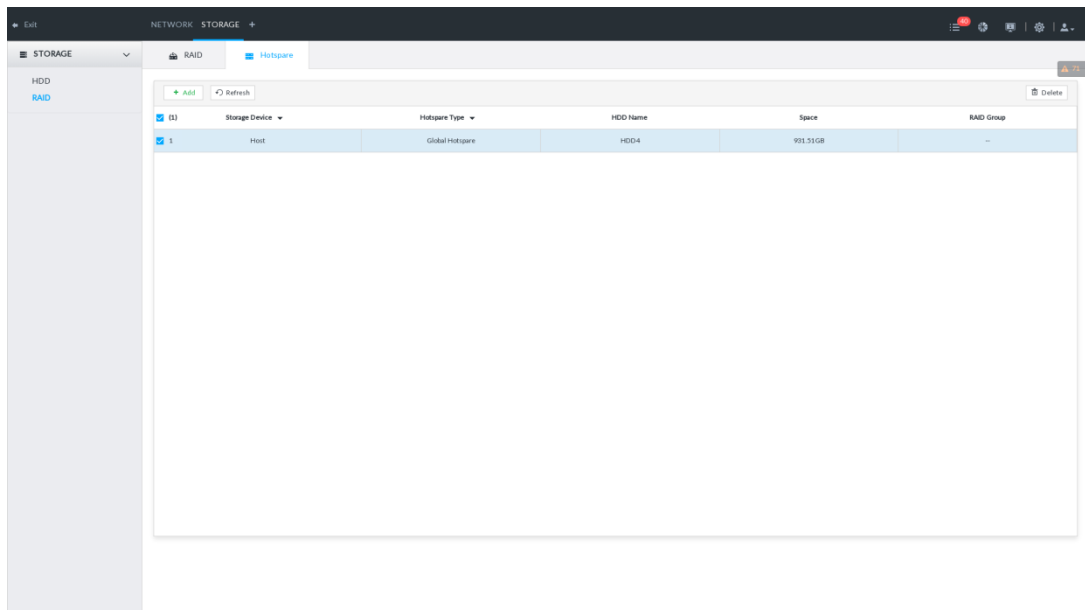

Figure 6-79

**Note**

Select a hotspare HDD and then click Delete, it is to delete hotspare HDD.

## 6.6 Account

Device account adopts two-level management mode: user/user group. You can manage user and user group basic information. To conveniently manage the user, we recommend the general user authorities shall be lower than the user of high-level.

## 6.6.1 User group

Different users may have different authorities to access the device. You can category the users to different groups. It is easy for you to maintain and manage the user information.

- System max supports 64 user groups. User name max supports 64-character.
- System has two default user groups (read-only): admin/ONVIF.
- Create new user group under the root.

### 6.6.1.1 Add User Group

It is to create user group to manage users.

#### Steps

Step 1 On Setting interface click , or click  and select Account.

Enter Account interface.

Step 2 Select root node at the left list and then click  at the bottom left corner.

System creates one user group and displays Attribute interface. See Figure 6-80.

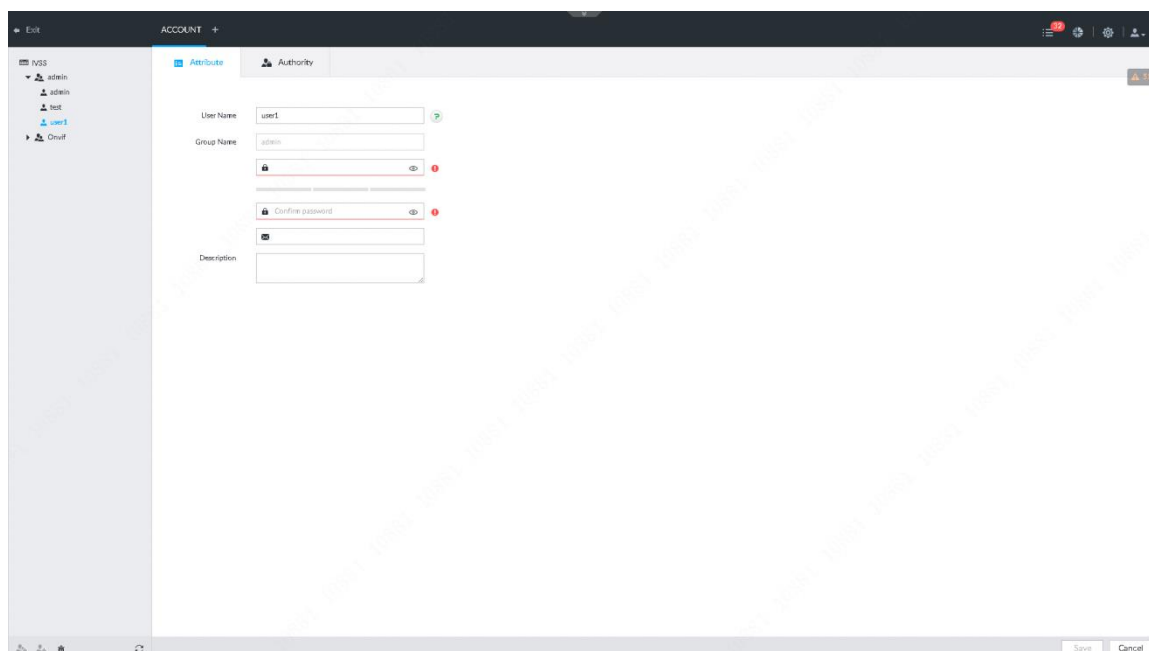

Figure 6-80

Step 3 Set parameters.

Name	Function
Name	Set user group name. The name ranges from 1 to 64-digital. It can contain English letters, number and special character("_", "@", ".").
Group name	It is to display user group belonging organization node. System automatically recognizes the group name.
Email	It is to set user group e-mail name.
Description	It is to input user group description information.
User list	It is to display user information of current group.

Step 4 Select user authority.

1. Click Authority tab.

Enter Authority interface. See Figure 6-81.

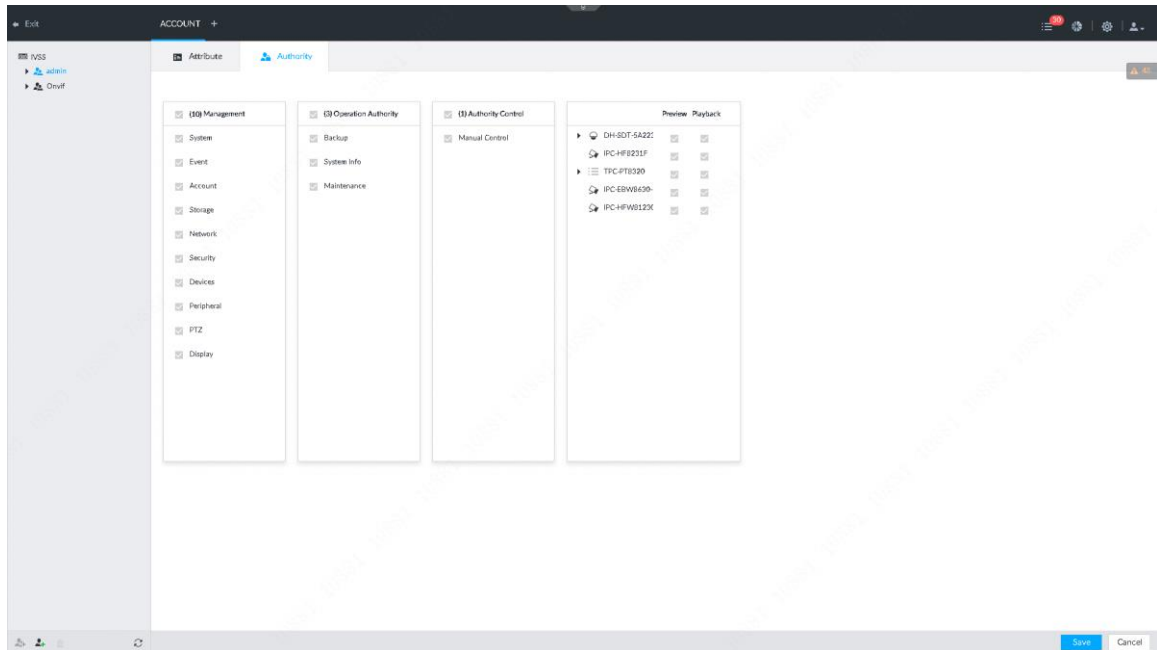

Figure 6-81

2. Set user authorities according to actual situation.

- : means it has the corresponding right.
- Check the box at the top of the authority list to select all rights of current category.

Step 5 Click OK to save.

### 6.6.1.2 Delete User group

#### Note

- Before you delete a user group, please delete all users of current group first.
- Admin and ONVIF user cannot be deleted.

On account interface, select a user group and then click to delete.

### 6.6.2 Device User

The device user is to access and manage the device. System default administrator is **admin**.

#### 6.6.2.1 Add User

It is to add a user and then set corresponding authorities so that the user can access the resources within its own rights range.

#### Note

User authorities adopt the user group authorities settings. It is read-only.

### Steps

Step 1 On Setting interface click , or click and then select Account.  
Enter Account interface.

Step 2 Select **admin** user group or other newly added user group, and then click at the bottom left corner.

Enter Authority interface. See Figure 6-82.

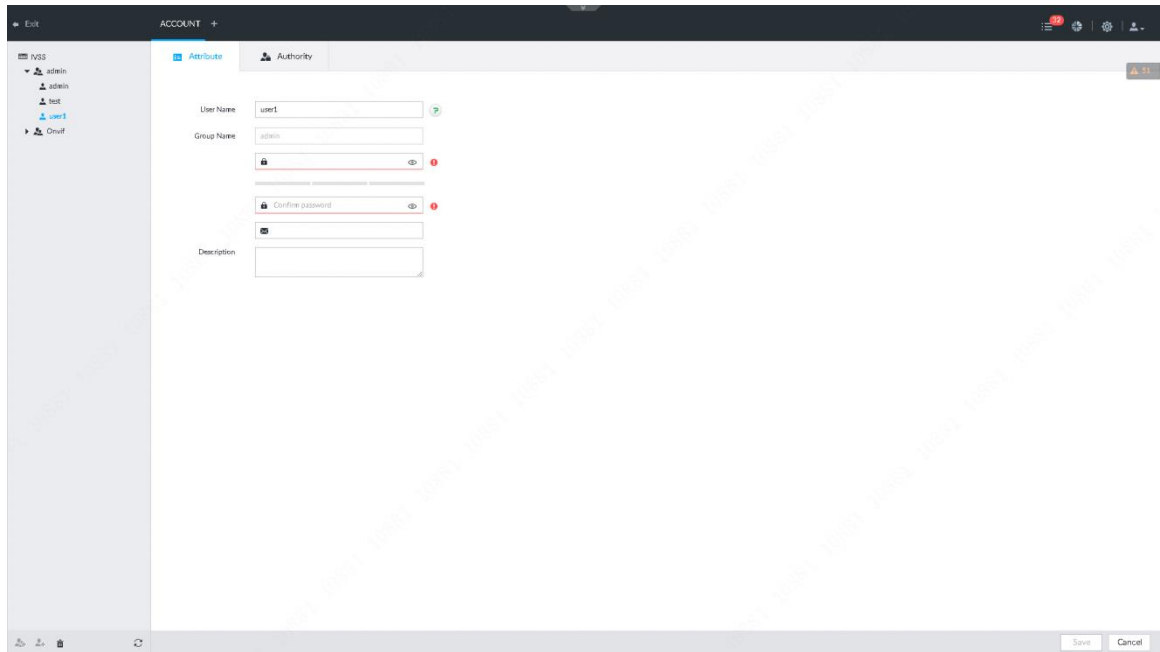

Figure 6-82

Step 3 Set parameters.

Step 4 (Optional) Click Authority tab to view user rights. See Figure 6-83.

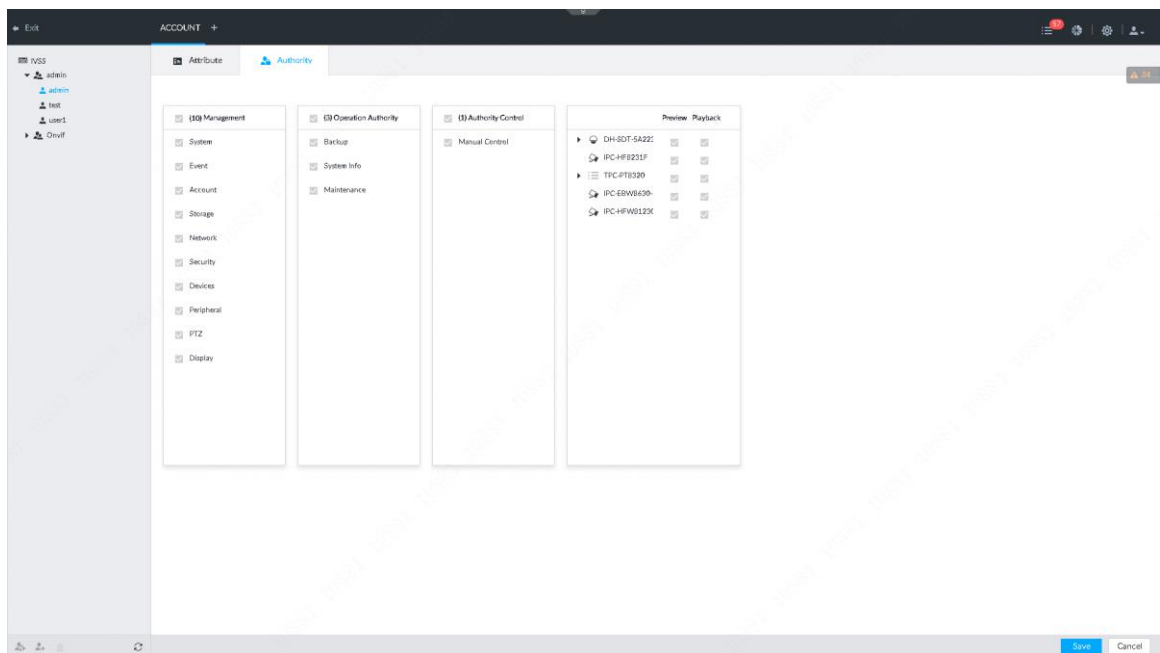

Figure 6-83

Step 5 Click Save button.

### 6.6.2.2 Edit user

The user of account management authority can change its own and other user information.

#### Steps

Step 1 On Setting interface click , or click  and then select Account.

Enter Account interface.

Step 2 Select a user.

Enter Attribute interface. See Figure 6-84.

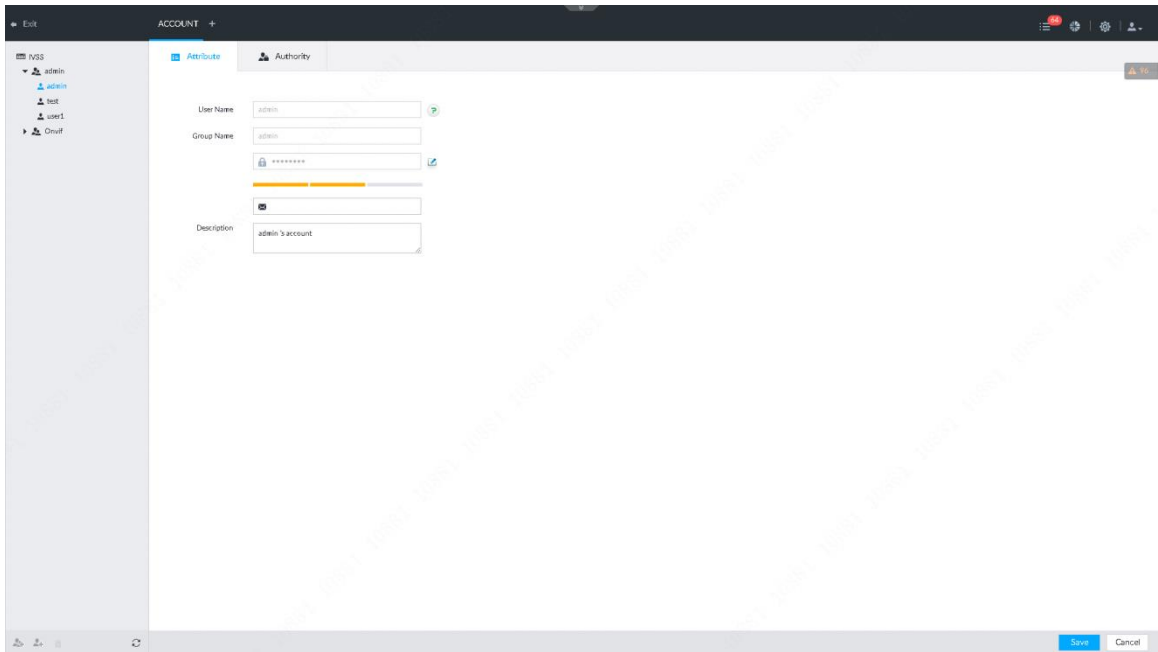



Figure 6-84

Step 3 Modify user password.

 **Note**

Click the icon  at the top right corner, and then select modify password to change user password.

1. Click .

Enter Change password interface. See Figure 6-85.

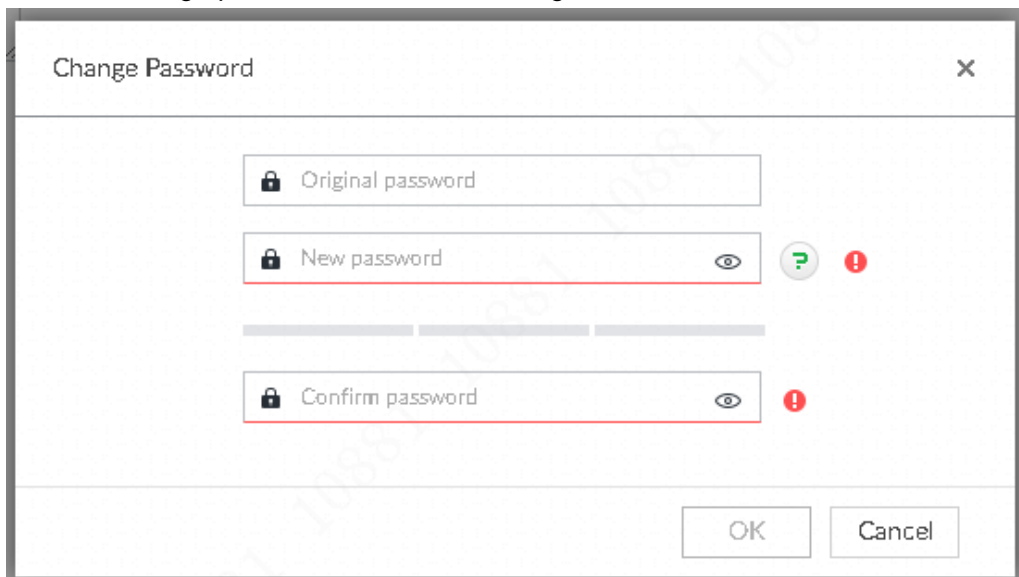

Figure 6-85



2. Input old password and then input new password and then confirm.
3. Click OK button.

Step 4 Refer to above sheet to set other parameters.

**Note**

Cannot change user name and user group.

Step 5 Click Save.

### 6.6.2.3 Delete User

Enter account interface, select a user and then click to delete.

### 6.6.2.4 Reset password

You can use email or answer the security questions to reset password once you forgot.

## Steps

Step 1 Enter IVSS login interface. See Figure 6-86.

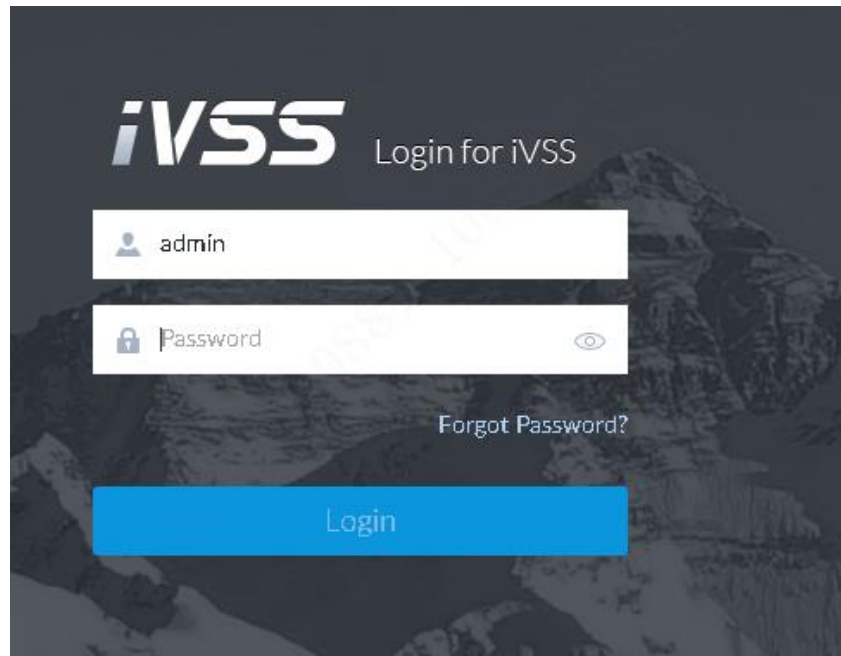

Figure 6-86

Step 2 Input user name **admin** and then click Forgot password.

Step 3 Reset login password.

Step 4 Click Next.

Enter new password interface.

Step 5 Set parameters.

## 6.6.3 ONVIF

When the remote device is connecting with the device via the ONVIF user, please use the verified ONVIF account to connect to the DVR.



**Note**

System adopts three ONVIF user groups (admin, user and operator). You cannot add ONVIF user group manually.

### 6.6.3.1 Add ONVIF User

It is to add ONVIF user.



### Note

Cannot add user under ONVIF group directly.

### Steps

Step 1 On Setting interface click , or click  and then select Account.

Enter Account interface.

Step 2 Select user group under ONVIF.

System displays user attribute interface. See Figure 6-87.

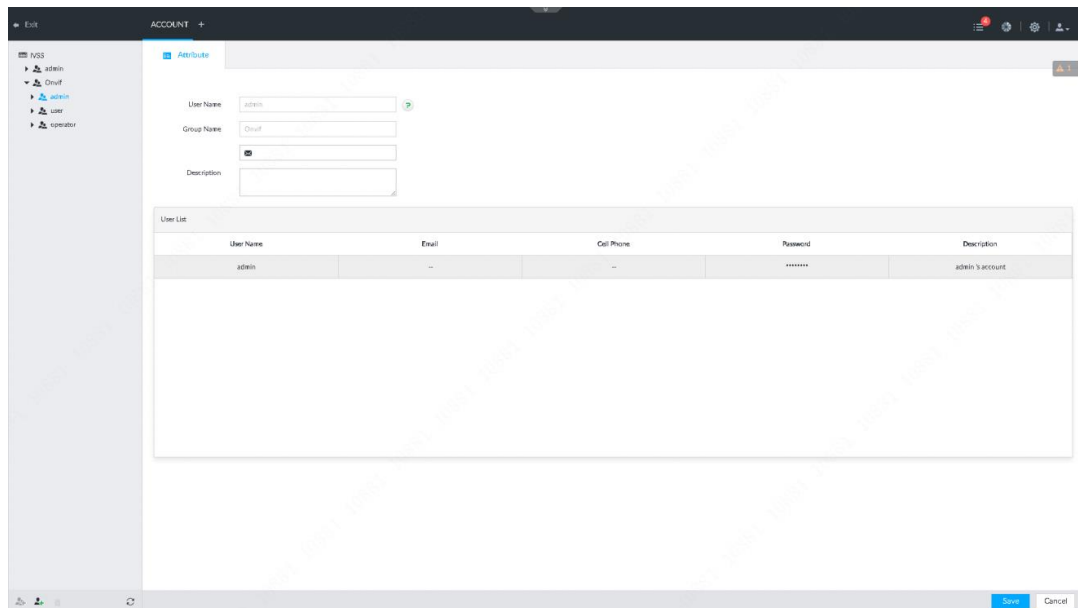



Figure 6-87

Step 3 Click .

Enter Attribute interface. See Figure 6-88

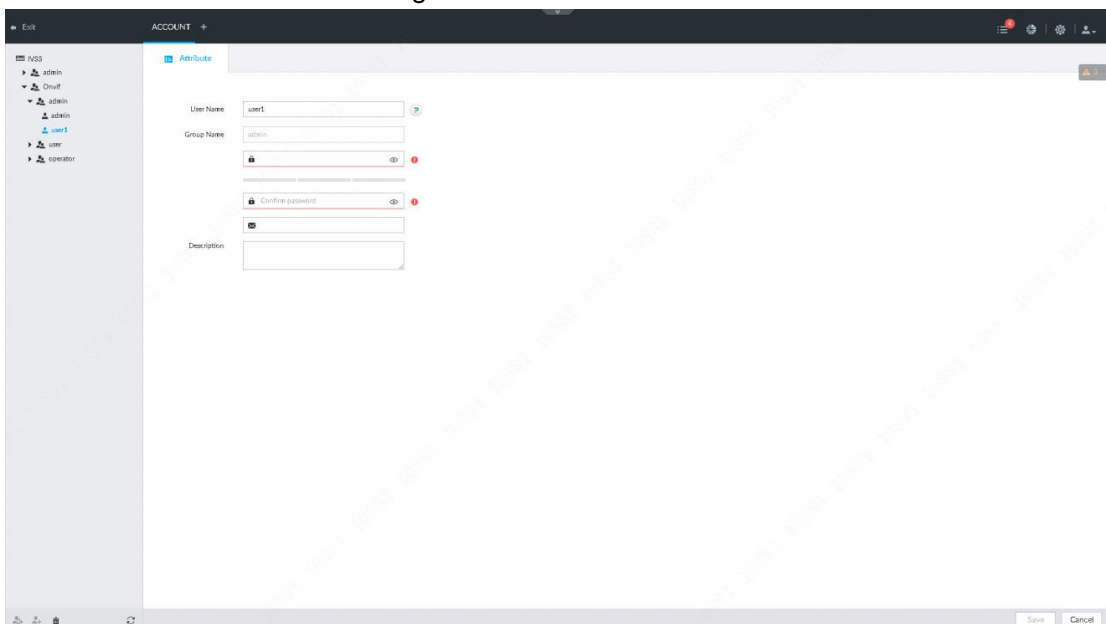



Figure 6-88

#### Step 4 Set parameters.

Name	Function
Name	It is to set ONVIF user name. The name ranges from 1 to 31-digital. It can contain English letters, number and special character("_", "@", ".").
Group name	It is to display user group name. System automatically displays.
Password	It is to set ONVIF user password. <ul style="list-style-type: none"> <li>The password ranges from 8 to 32 digitals. It can contain letters, numbers and special characters (excluding “”,””,“,”,“,.”,“&amp;”) . The password shall contain at least two categories. Usually we recommend the strong password.</li> <li>After input password, use mouse to press  to display password. Release the mouse or move mouse to other position, the password is displayed at hidden mode again.</li> </ul>
Confirm password	
Description	Input ONVIF user description information.

#### Step 5 Click Save.

### 6.6.3.2 Delete ONVIF User

Enter account interface, select a ONVIF user and then click .

## 6.7 Security Strategy

It is to set security strategy to guarantee device network and data safety. It includes HTTPS, set host IP access rights, enable network security protection ,etc.



#### Note

HTTPS function is for WEB and IVSS browser only. Refer to the actual interface for detailed information.

### 6.7.1 HTTPS

HTTPS can use the reliable and stable technological means to guarantee user information and device security and communication data security. After install the certificate, you can use the HTTPS on the PC to access the device.

#### 6.7.1.1 Install Certificate

System supports these two certificates. Please install according to your actual requirements.

Manually create the certificate.

- Install the manually created certificate.
- Install the created certificate.

##### 6.7.1.1.1 Install the created certificate



It is to install the created certificate manually. It includes creating the certificate on the device, and downloading and installing the certificate on the PC.



#### Note

- Please create and install server certificate if it is your first time to use HTTPS or you have changed device IP address.
- After create and install server certificate, please download and install root certificate on the new PC, or you download the certificate and then copy to the new PC.

### Steps

Step 1 On Setting interface click , or click  and then select Security->Credential.  
Enter Credential interface. See Figure 6-89.

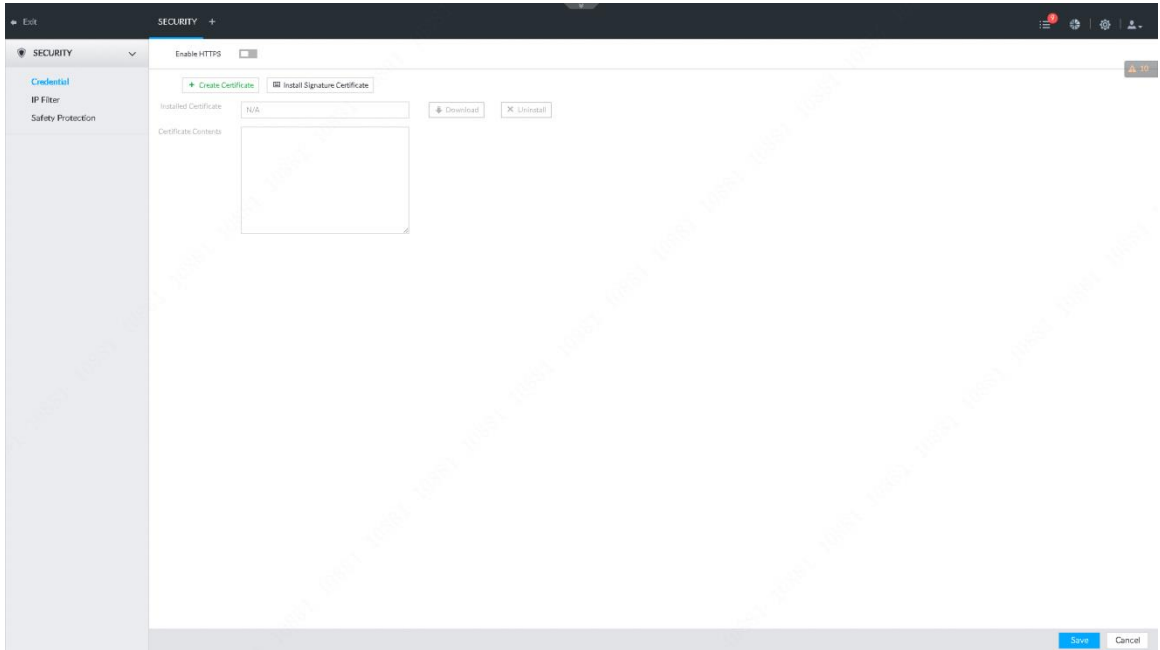

Figure 6-89

Step 2 Create certificate on the device.  
1. Click Create certificate.  
Enter create certificate interface. See Figure 6-90.

Country	<input type="text"/>	!
IP/Domain	<input type="text"/>	!
Term of Validity	<input type="text" value="365"/>	days
Province	<input type="text"/>	
Position	<input type="text"/>	
Organization	<input type="text"/>	
Organization Unit	<input type="text"/>	
Email	<input type="text"/>	

Figure 6-90

2. Set country, IP/domain, valid date ,etc.

**Note**

- Country, IP/domain, valid date are compulsive items. Other items are optional.
- IP/domain shall be the device IP or the domain.

3. Click OK.

System begins creating certificate. It displays certificate information. See Figure 6-91.

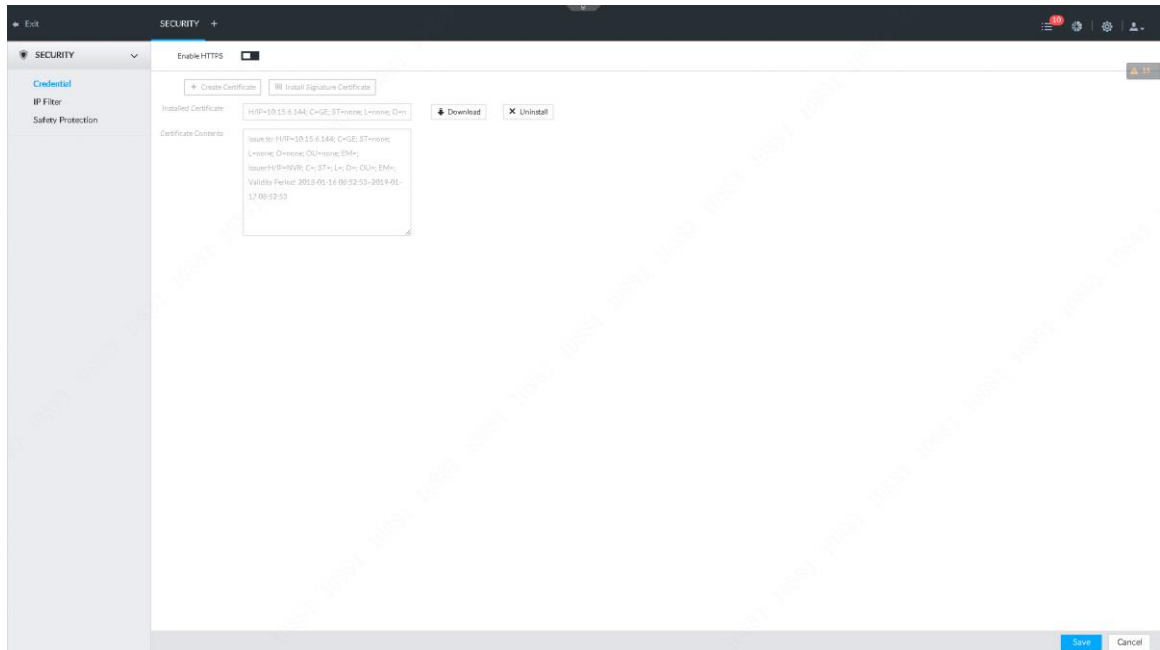

Figure 6-91

Step 3 Download certificate.

1. Click Download .

System displays Opening ca.crt interface. See Figure 6-92.

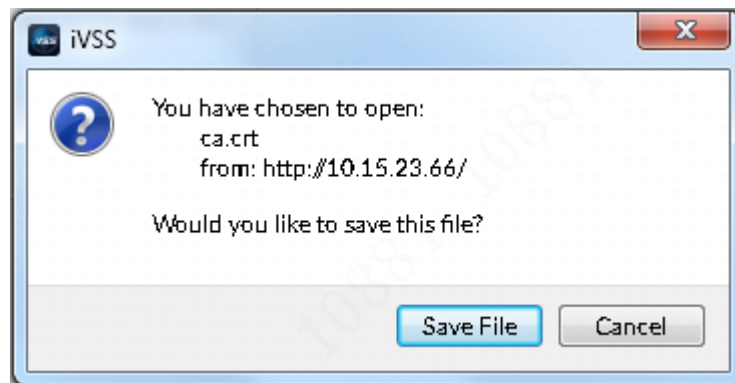

Figure 6-92

2. Click Save file to select file saved path.
3. Click Save.

System begins downloading certificate file.

Step 4 Install certificate on the PC.

1. Double click the certificate.  
System displays open file-security warning interface.
2. Click Open.

System displays certificate interface.

3. Click Install certificate.  
Enter certificate import wizard.
4. Follow the prompts to import the certificate.

System goes back to certificate interface.

Step 5 Click OK to complete certificate installation.

6.7.1.1.2 Install the signed certificate

It is to uploading the signed certificate to install.

## Preparations

Before the installation, make sure you have get safety and signed certificate.

## Steps

Step 1 On Setting interface click , or click  and then select Security->Credential.

Enter credential interface. Figure 6-93

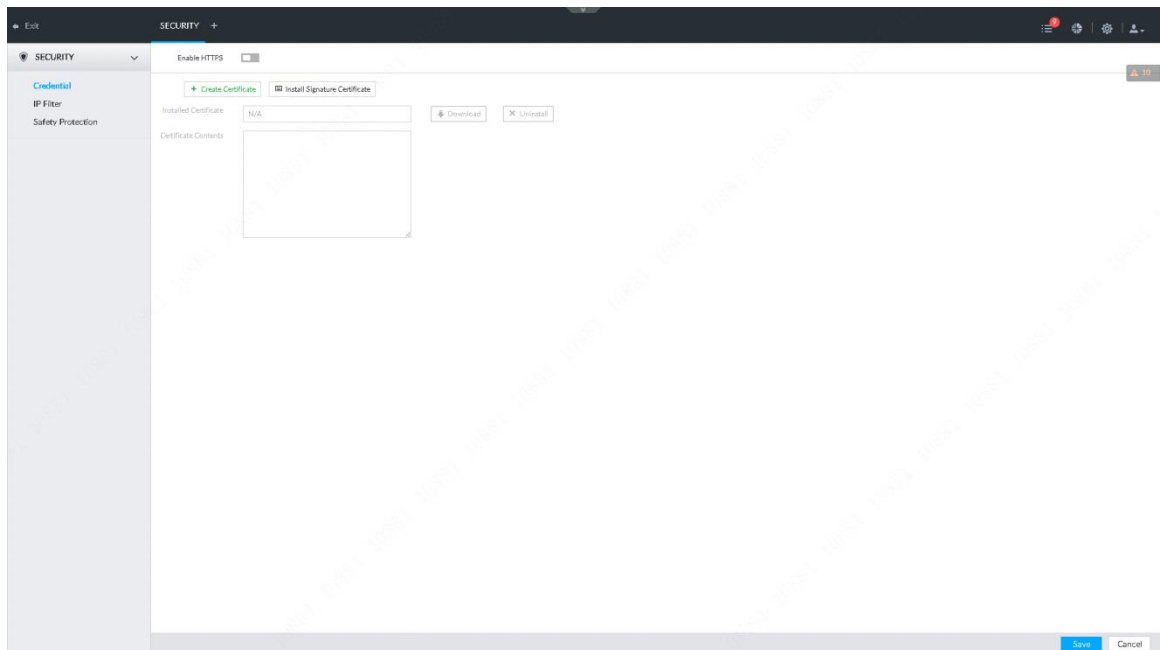

Figure 6-93

Step 2 Click the install the signed certificate.  
System displays install the signed certificate interface. See Figure 6-94.



Figure 6-94

Step 3 Click Browse and then select certificate and credential file.

Step 4 Click Install.

System begins install certificate, and then displays certificate information after the installation.

Step 5 Install the certificate on the PC. Refer to Step 4 of 6.7.1.1.1 Install register certificate for detailed information.

### 6.7.1.2 Enable HTTPS

After install the certificate and enable HTTPS function, you can use the HTTPS on the PC to access the device.

#### Steps

Step 1 On Setting interface click , or click  and then select Security->Credential. Enter credential interface.

Step 2 Click  to enable HTTPS function. See Figure 6-95.

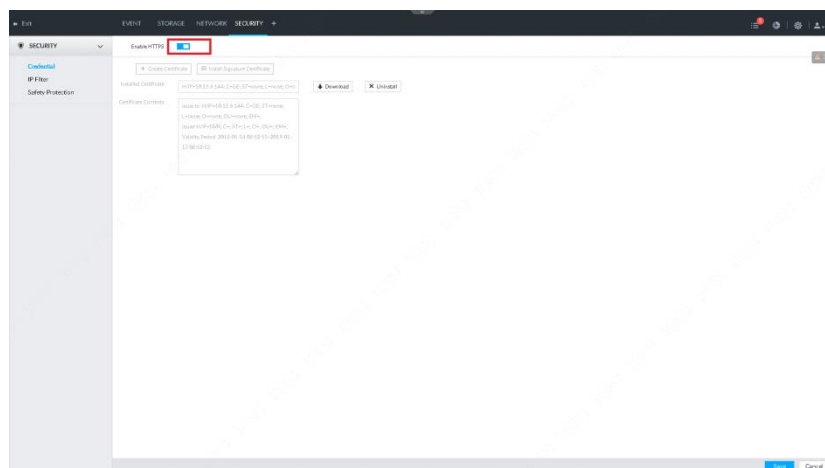

Figure 6-95

Step 1 Click Save to save settings.

After successfully save the settings, you can use HTTPS to access the WEB interface.

Open the browser and then input https://192.168.4.8:port, click **【Enter】**, system display login

interface.

 **Note**

192.168.4.8 is device IP or the domain name.

Port refers to device HTTPS port number. If the HTTPS port is the default value 443, just use https://192.168.4.8 to access.



### 6.7.1.3 Uninstall the certificate

It is to uninstall the certificate.

 **Note**

You cannot use the HTTPS function after you uninstall the certificate.

#### Steps

- Step 1 On Setting interface click , or click  and then select Security->Credential.  
Enter credential interface. See Figure 6-96.

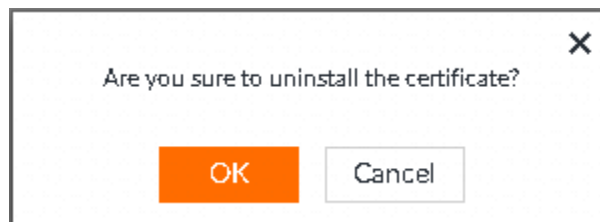



Figure 6-96

- Step 2 Click OK.  
System displays uninstall interface.
- Step 3 Click OK to uninstall the certificate.

### 6.7.2 IP Filter

It is to set the specified IP addresses to access the device. It is to enhance device network and data security.

#### Steps

- Step 1 On Setting interface click , or click  and then select Security->IP Filter.  
Enter IP filter interface. See Figure 6-97.



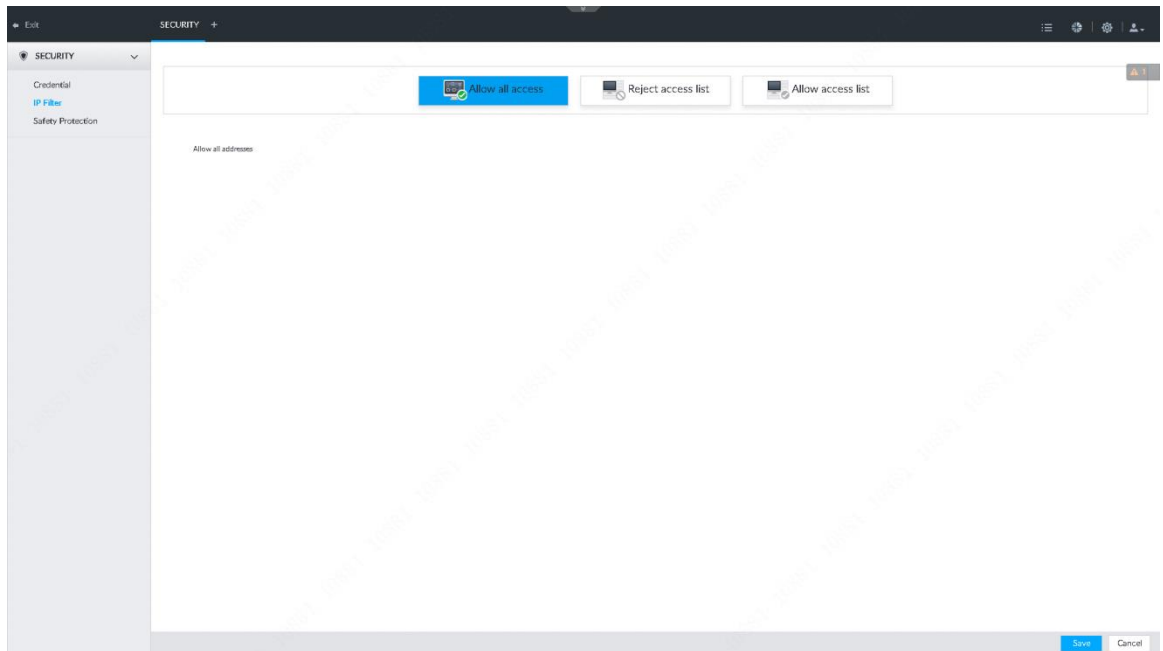

Figure 6-97

Step 2 It is to select IP access rights.

- Allow all access: it is to allow all IP addresses on the same IP segment to access the device.
- Reject access list: It means the IP address in the list cannot access the device.
- Allow access list: It means the IP address in the list can access the device.

Step 3 Add IP host.

**Note**

The following steps are to set reject access list or allow access list.

1. Click Add.  
Enter Add interface. See Figure 6-98.

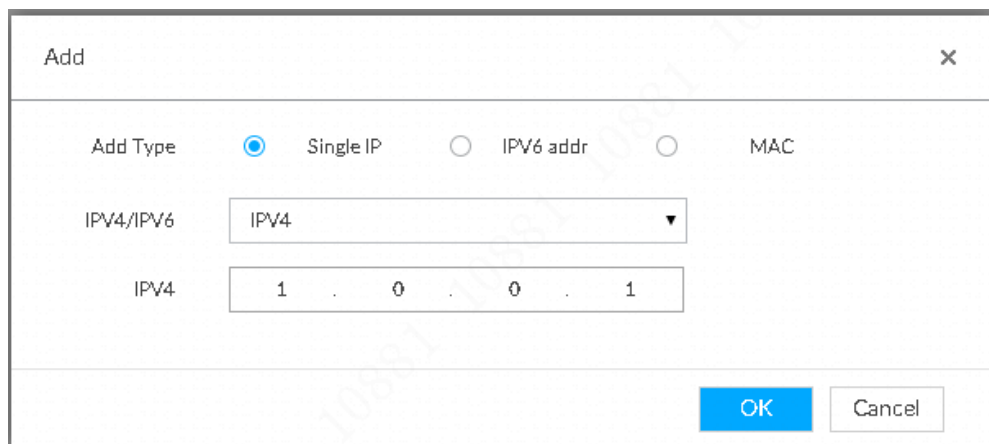

Figure 6-98

2. Select add mode, and set IP host IP address or MAC address.
  - Single IP address: Input host IP address.
  - IP segment: Input IP segment. It can add IP addresses in current IP segment.
  - MAC address: Input IP address MAC address.
3. Click OK to add the IP host.

System displays added IP host list. See Figure 6-99.

**Note**

- Click Add to add more IP host.
- Click to edit the IP host.
- Select an IP host and then click delete to delete.

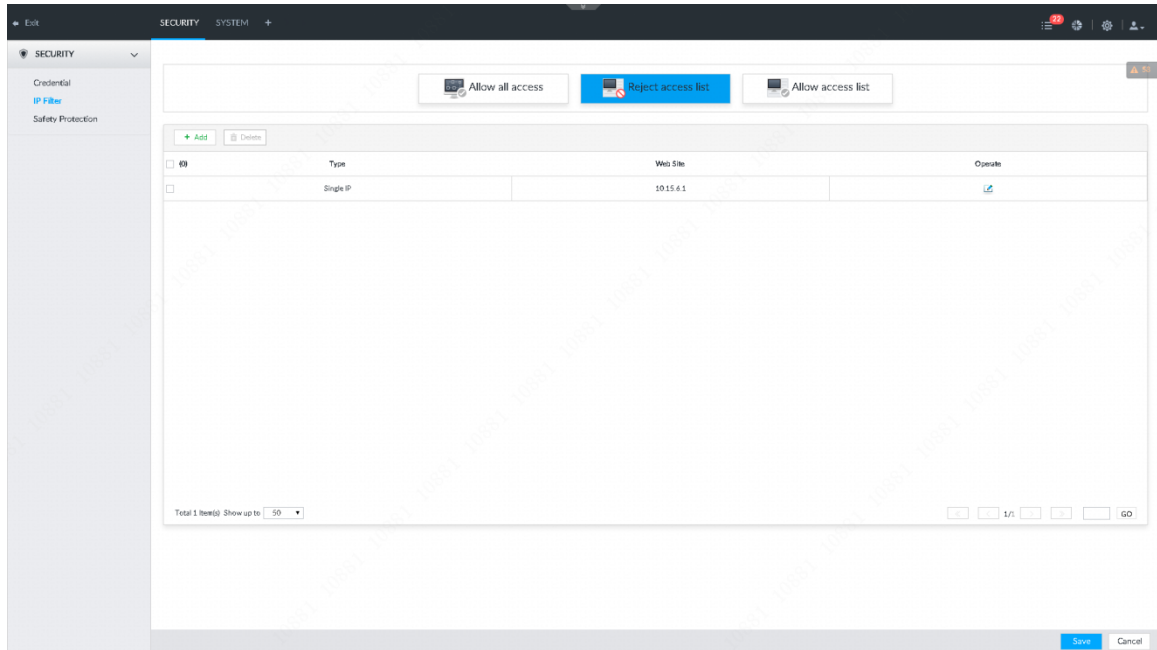

Figure 6-99

Step 4 Click Save.

### 6.7.3 Safety Protection

It is to set the login password lock strategy once the login password error has exceeded the specified threshold. System can lock current IP host for a period of time.

#### Steps

- Step 1 On Setting interface click , or click , and then select Security->Safety Protection. Enter safety protection interface. See Figure 6-100.

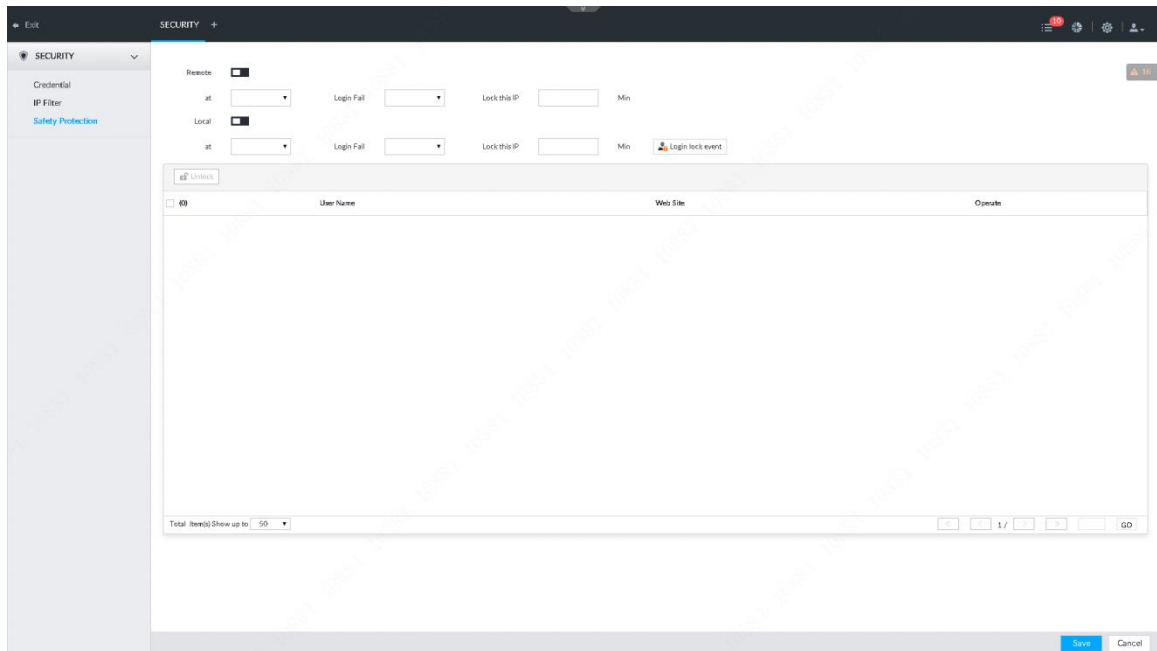

Figure 6-100

Step 2 Click  to enable security protection function.

- Remote: When you are using WEB, IVSS browser to access the device remotely, once the login password error has exceeded the threshold; system locks the IP host for a period of time.
- Local: When you are accessing the device local menu, once the login password error has exceeded the threshold, system locks the account for a period of time.

Step 3 Set lock strategy according to the actual situation.

Step 4 Click Save.

Once the IP host has been locked, you can view the locked IP host on the list. See Figure 6-101.

Select an IP host and then click Unlock, or click the  of the corresponding IP host to unlock.

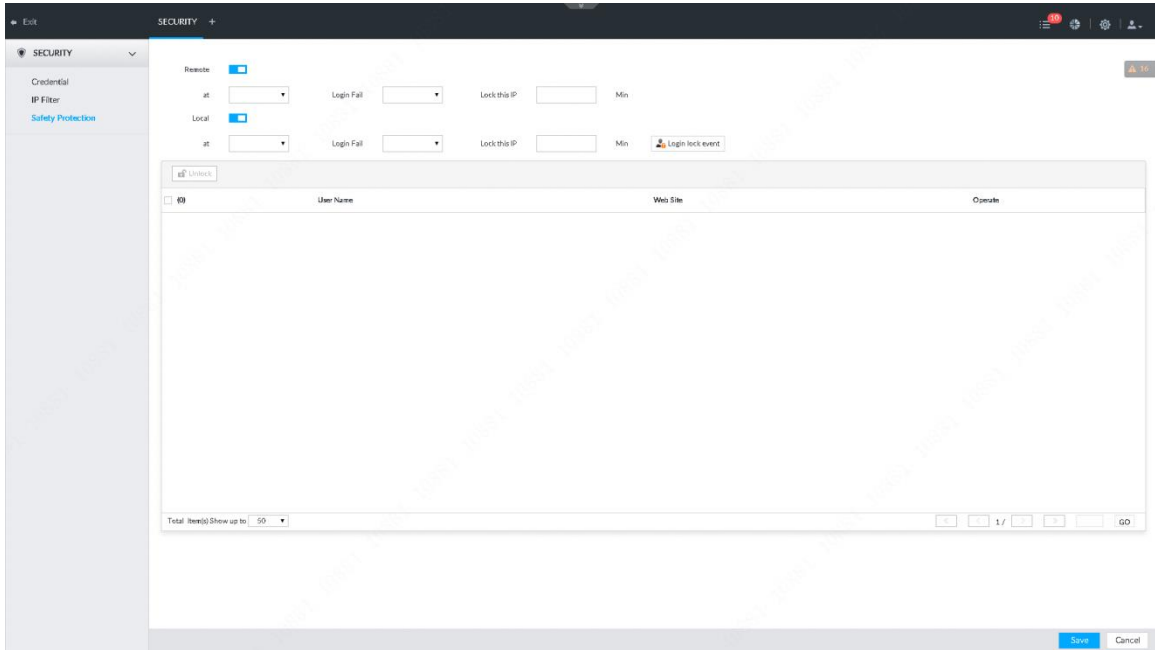

Figure 6-101

## 6.8 System Manager

It is to set system basic settings such as general parameters, calendar ,etc.

### 6.8.1 Parameters

It is to set system language, user auto logout time, virtual keyboard, mouse speed ,etc.

#### Steps

- Step 1 On Setting interface click , or click  and then select System->General->System. Enter System interface. See Figure 6-102.

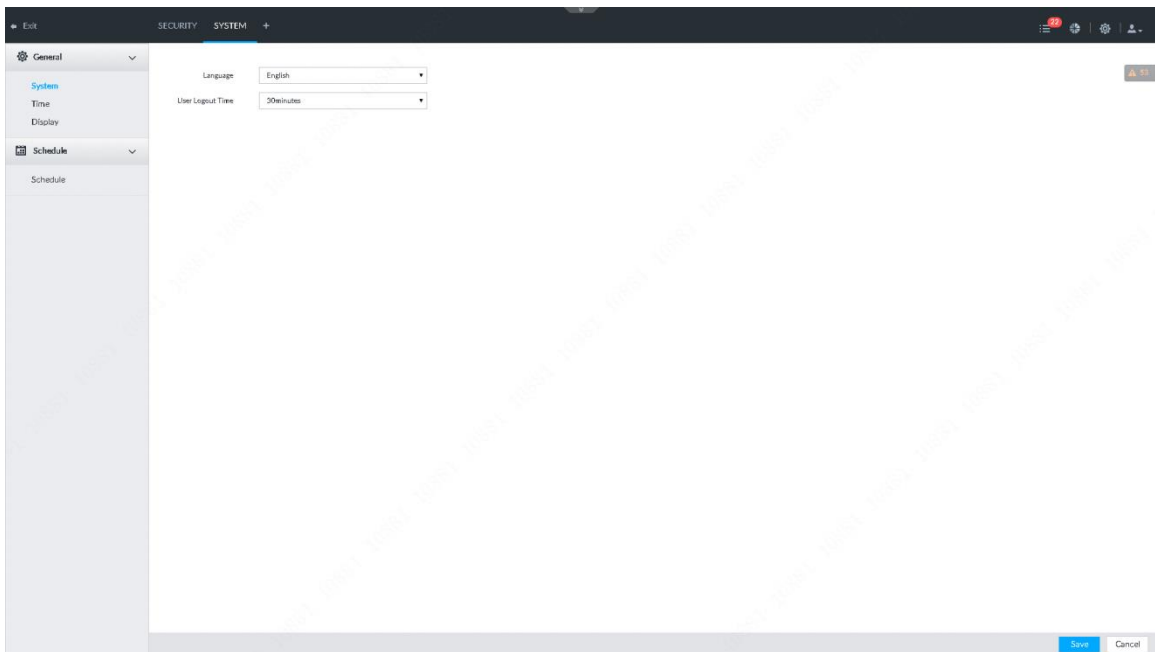

Figure 6-102

Step 2 Set parameters.

Name	Function
Language	It is to set system language.
Logout time	It is to set auto logout interval once you remains inactive for a specified period. The user needs to login again to operate. If you set as Never, system does not automatically logout user.
Virtual keyboard	It is to enable virtual keyboard function on the local menu. Refer to chapter 3.2 Virtual keyboard for detailed information. <b>Note</b> This function is for local menu only.
Mouse move speed	It is to set mouse movement speed on the local interface. <b>Note</b> This function is for local menu only.

Step 3 Click Save.

## 6.8.2 Time

It is to set system time. After enable NTP function, device can automatically synchronize time with the NTP server.

### Steps

Step 1 On Setting interface click , or click  and then select System->General->Time. Enter Display interface. See Figure 6-103.

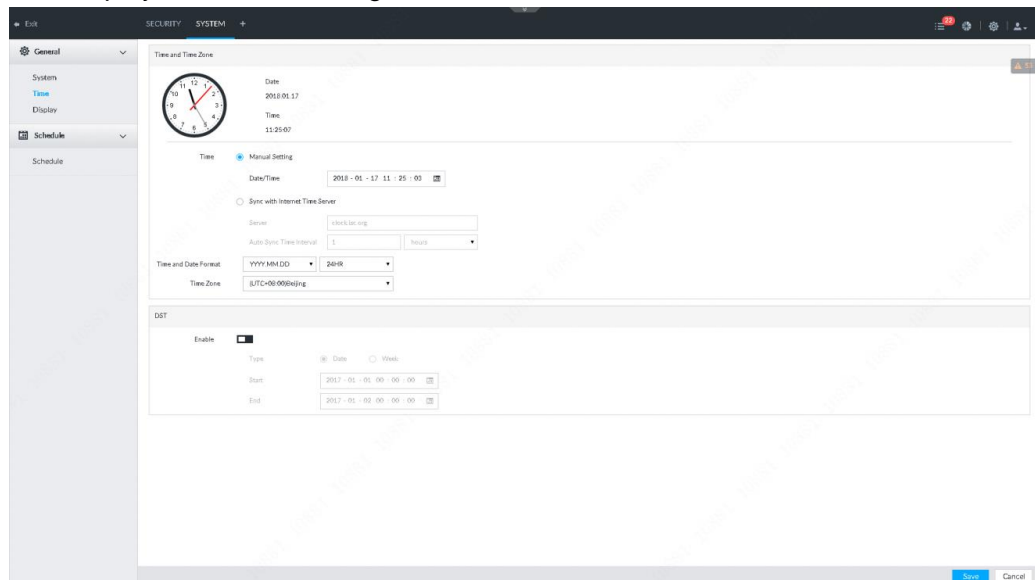



Figure 6-103

Step 2 Set parameters.

Step 3 (Optional) Set DST.

1. Click  to enable DST.
2. Select DST mode. It includes date and week.
3. Set DST start time and end time.

Step 4 Click Save.

### 6.8.3 Display

It is to set connected displayer resolution and refresh interval.

#### Steps

Step 1 On Setting interface click , or click  and then select System->General->Display. Enter Display interface. See Figure 6-104.

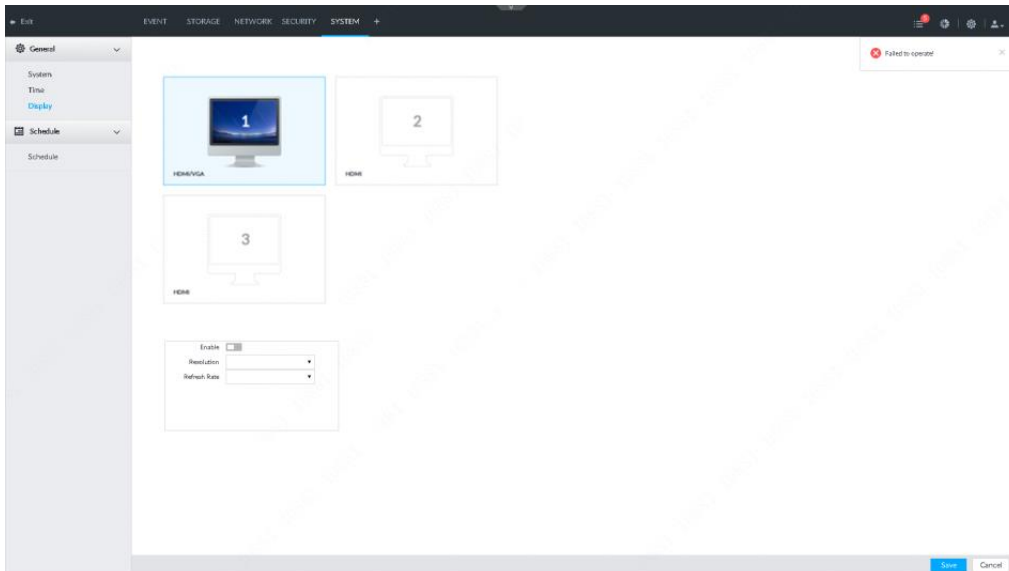

Figure 6-104

#### Note

- SN 1~3 refers HDMI 1~HDMI 3. Among which, HDMI/VGA is the main displayer, the VGA and HDMI 1 outputs the same video.
- VGA and HDMI 1 are outputting the same video source. Three HDMI ports can output different video source.

-  means connected and enabled displayer.  means connected but has not enabled displayer.  means disconnected displayer.

Step 2 Select displayer.



Step 3 Set parameters.

Name	Function
Enable	Start or stop displayer.  <b>Note</b> System adopts main screen by default. The main screen cannot be disabled.
Resolution	It is to set displayer resolution. Different displayers support different resolutions. Refer to your actual interface for detailed information.
Refresh	It is to set displayer refresh frequency.

## 6.8.4 Calendar

It is to set schedule calendar. When you are configuring alarm, record arm/disarm period, system can call the schedule calendar directly. System only triggers the corresponding operations during the specified calendar.

### Steps

- Step 1 On Setting interface click , or click  and then select System->Schedule->Schedule. Enter Schedule interface. See Figure 6-105.

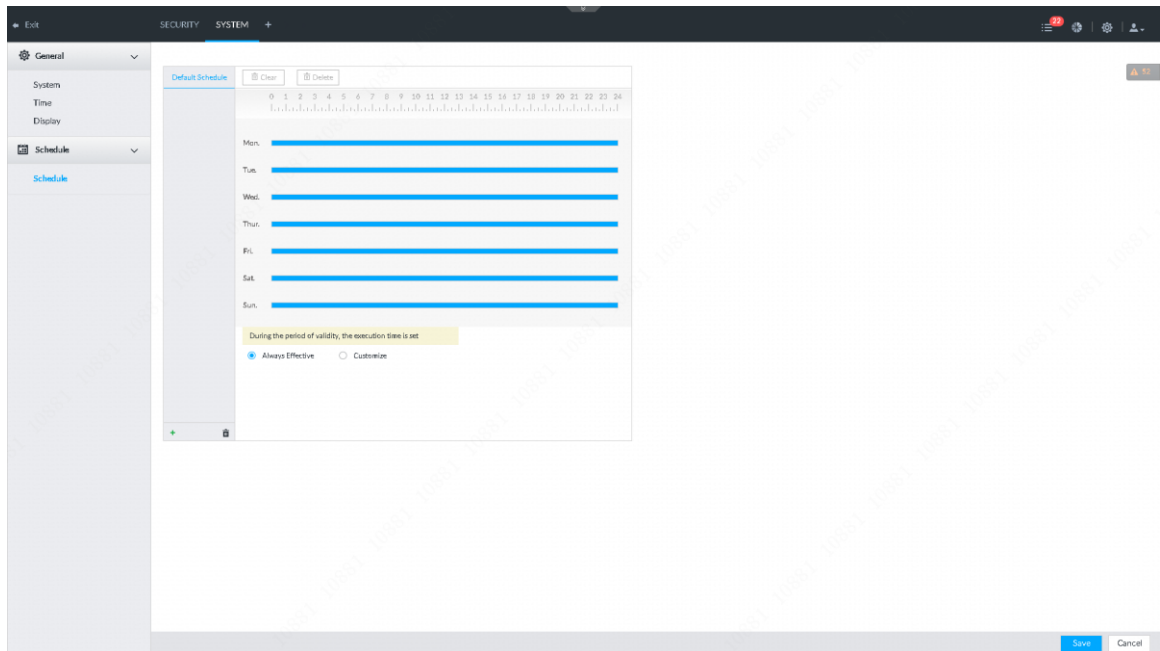

Figure 6-105

- Step 2 Add calendar

1. Click .

Enter add calendar interface. See Figure 6-106.

Figure 6-106

2. Set calendar name.

3. Click OK.

 **Note**

Select a calendar and then click  to delete.



Step 3 Set calendar working mode. It includes always valid and customized.

Step 4 Draw calendar valid period.

 **Note**

- The step is for customized mode only.
- Each calendar max supports 50 valid periods.
- The blue are on the time bar means the valid period.

On the time bar, you can:

- Click the blue are, you can view , drag the  to adjust the valid period start time/end time.
- Press the any blank space on the time bar and drag to the right to add a valid period.
- Click Clear to clear valid period of current calendar.
- Select a valid period and then click Delete to delete the period.

Step 5 Click Save.

## 6.9 Logout/Reboot/Shut down

It is to logout, reboot, shutdown the device.

 **Note**

The reboot and shut down function is for local menu interface only.

### Logout

Click  and then select logout.

### Reboot

Click  and then select reboot. System pops up confirm dialogue box. Click OK to reboot.

### Shutdown



CAUTION

Unplug the power cable may result in data (record, image) loss. We strongly recommend Mode 1.

- Mode 1(recommended): Click  and then select shut down, system pops up confirm dialogue box and then click OK to shut down.
- Mode 2: Use power on-off button on the device.
  - ◇ 8-HDD series device: click the power on-off button at the rear panel.
  - ◇ Other series products: Press the power on-off button for at least 4 seconds.
- Mode 3: Unplug the power cable.



## 7 WEB

System supports general browser such as Google Chrome, Firefox to access the WEB to manage the device remotely.



### CAUTION

- When you are using general browser to access the WEB, system supports setting function only. It cannot display the view. We strongly recommend you use IVSS browser. Refer to chapter 8 IVSS browser introduction for detailed information.
- Before you use WEB function, please make sure device and PC network connection are right.
- System supports general browser such as Google Chrome, Firefox to access WEB. Please use the latest browser version.

### Login WEB

Step 1 Open the browser and input IP address, click **【Enter】** button.  
Enter WEB login interface. See Figure 7-1.



Figure 7-1

Step 2 Input user name and password.

Step 3 Click Login.

Enter WEB interface. The WEB function is similar to the local menu. Refer to chapter 5 Operation and chapter 6 Configuration for detailed information. See Figure 7-2.

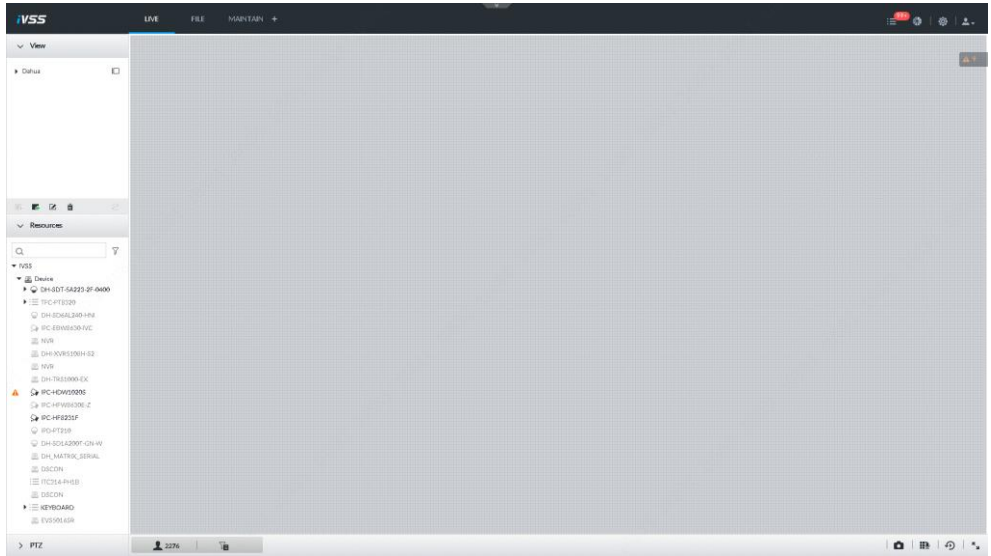

Figure 7-2

## 8 IVSS Browser Introduction

System supports working with the corresponding general applications (IVSS) to access the device remotely. It is to realize system configuration and operations.

### 8.1 IVSS browser

If you are using general browser to login the device, WEB login interface displays IVSS browser information. You can get IVSS installation package.

#### Steps

- Step 1 Open the browser and input IP address, click **【Enter】** button.  
Enter WEB login interface. See Figure 8-1.

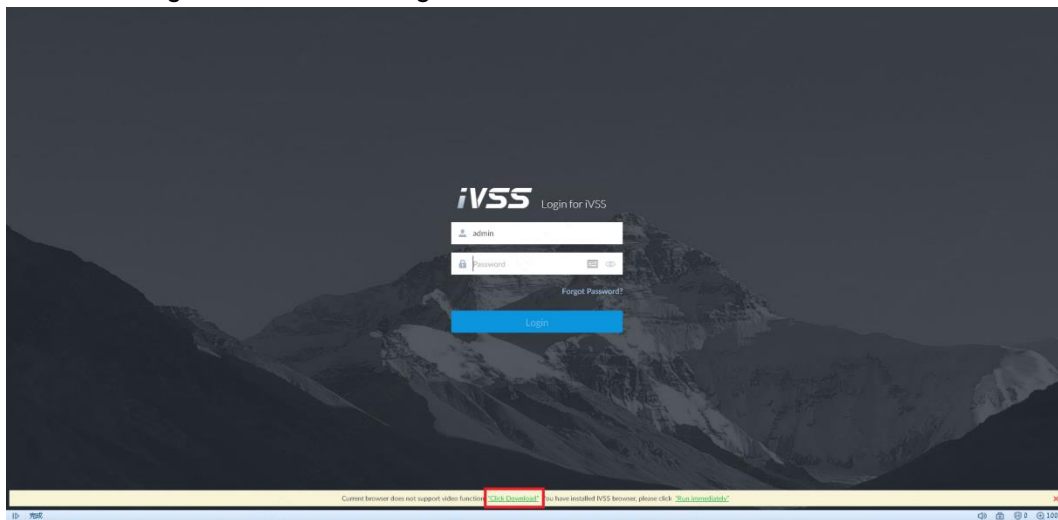

Figure 8-1

- Step 2 Click Download to download IVSS browser installation package.

 **Note**

If you have downloaded IVSS browser packages, click Run to enable IVSS browser.

- Step 3 Double click the IVSS installation package.  
Enter installation interface. See Figure 8-2.



Figure 8-2

Step 4 Install IVSS browser.

- Install now.  
Click to agree user agreement and then click install now.
- Customized installation.
  1. Click to agree user agreement.
  2. Click Custom.  
Enter Customize installation interface. See Figure 8-3.

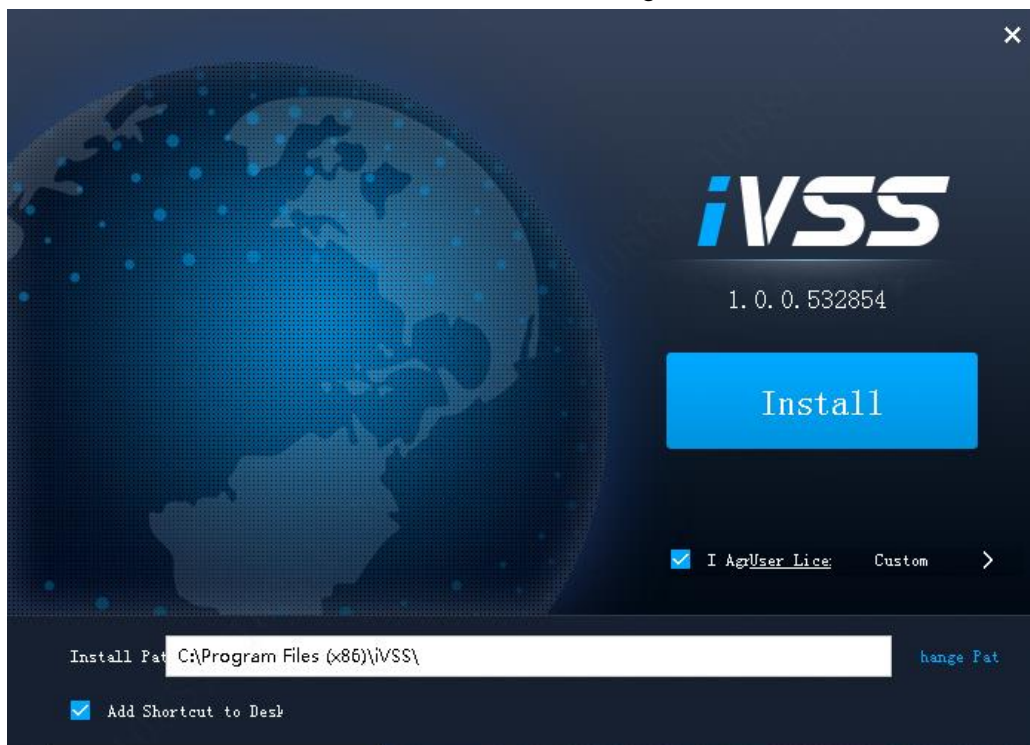

Figure 8-3

3. Set customized installation according to your actual requirements.
4. Click Install to install IVSS browser.

System displays installation complete interface. See Figure 8-4.



Figure 8-4

## 8.2 Login IVSS browser

After install IVSS browser, you can use the device IP address to access remotely.

### Steps

Step 1 There are two ways to enter IVSS browser main interface.

- On the IVSS browser installation interface (Figure 8-4) . Click Run.



- Double click the shortcut menu on the desktop

System displays IVSS browser interface.

#### Note

System display IVSS browser at full-screen by default. Click to display the task column. See Figure 8-5.



Figure 8-5

Icon	Function
	Input device IP address and then click the button to go to the login interface. Now the icon becomes as .Click to refresh the interface.
	Click to view login history record and IVSS browser version information. Refer to chapter 8.3 History record and chapter 8.4 Version information for detailed information.
	Click to minimize IVSS browser.
	Click to display IVSS browser at full-screen.

Icon	Function
	Click to close IVSS browser.

Step 2 Input device IP address and then click **【Enter】** or click ,  
Enter login interface. See Figure 8-6.

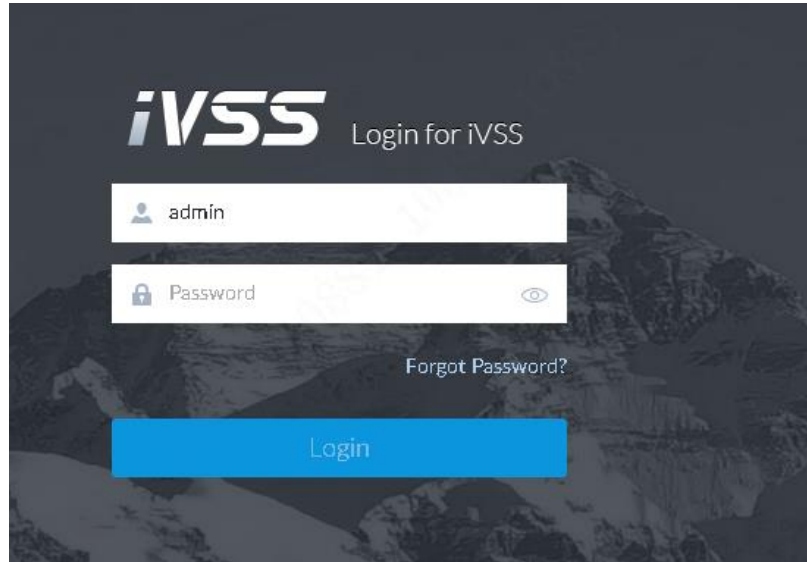



Figure 8-6

Step 3 Input device user name and password.

Step 4 Click Login.

System displays Live interface. IVSS browser function is general the same with the local interface. Refer to chapter 5 Operation and chapter 6 Configuration for detailed information.

### 8.3 History record

Click  and then select history record, enter history record interface. See Figure 8-7. It is to view history record.

- Click clear history to clear all history records.
- Click clear buffer to clear buffer data.

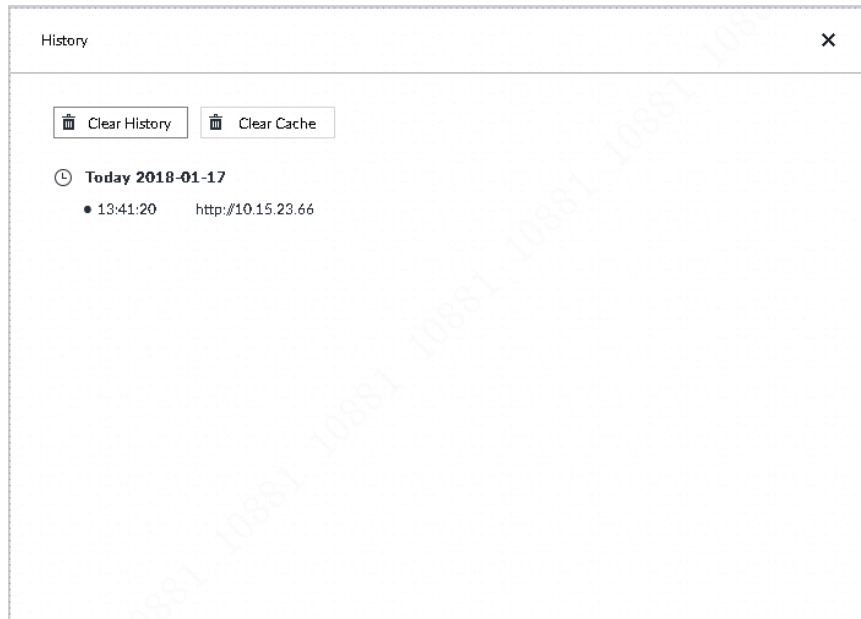



Figure 8-7

## 8.4 About IVSS

Click  and then select About, system display about interface. See Figure 8-8. It is to view IVSS browser version information.

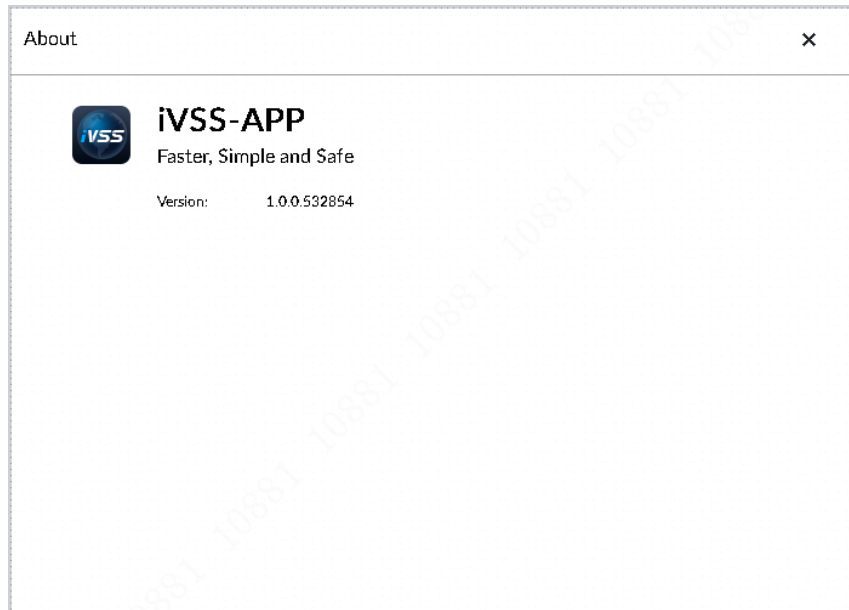



Figure 8-8

## 9 Appendix 1 FAQ

Problem	Possibilities
<p>After enable AI by device function, there is no human face comparison event.</p>	<ul style="list-style-type: none"> <li>● The AI module is offline</li> </ul> <p>On Live interface, click . From System-&gt;Maintain-&gt;Upgrade-&gt;AI module upgrade, check the AI module is online or not.</p> <ul style="list-style-type: none"> <li>● There are too much filter criteria on the AI display interface.</li> <li>● The registered remote device does not support human face detection function.</li> </ul> <p>Please enable AI by device function. Refer to 6.4.2.3.3 Human face detection for detailed information.</p> <ul style="list-style-type: none"> <li>● It is not in the deployment period,</li> <li>● There is no activation human face database or the human face database has no data.</li> <li>● The human face similarity setting is too high.</li> </ul>
<p>After enable AI by camera function, there is no human face comparison event.</p>	<ul style="list-style-type: none"> <li>● The human face comparison function has not been not enabled on the AI plan.</li> <li>● There is no human face database on the WEB interface of the remote device.</li> <li>● It is not in the deployment period,</li> </ul>
<p>There are no human face search results.</p>	<ul style="list-style-type: none"> <li>● The human face similarity setting is too high.</li> <li>● The selected remote device does not trigger the human face comparison.</li> <li>● There is no human face comparison on the search period</li> <li>● The specified human face image is not on the human face database.</li> </ul>



## 10 Appendix 2 Glossary

Glossary and Abbreviation	Note
DDNS	DDNS (Dynamic Domain Name System) is to map the user dynamic IP address to a specified domain analysis service. Each time, when the user connects to the network, the client can transmit the host dynamic address to the server application on the host of the service provider. The server applications are to provide the DNS service and realize dynamic domain analysis. That is to say, the user does not need to remember the changeable IP address, just uses the domain name to login the device or the address.
DHCP	DHCP (Dynamic Host Configuration Protocol) is a network protocol in the LAN. It is to automatically allocate IP address for the internal network or the ISP (internet service provider). It is to manage the computer IP address by the unified means of management.
DNS	DNS (Domain Name System) is to save the all host domain name and corresponding IP address in the network. It has the ability to change the domain to the IP address.
DVR	Digital Video Recorder.
HDMI	HDMI (High Definition Multimedia Interface) is a special digital interface suitable for audio/video transmission. It can transmit audio signal and video signal at the same time.
HTTPS	HTTPS (Hyper Text Transfer Protocol over Secure Socket Layer) is a HTTP channel for security purpose. The HTTPS has defines the browser the world wide web service safety communication rule. It adopts encryption technology to guaranty safety access to the webpage
IP	Internet Protocol
IPC	IP Camera
NTP	NTP (Network Time Protocol) is a protocol to synchronize computer time. It adopts wireless network protocol UDP so that the computer time synchronizes with the server or the time source. It is to provide time correction of high accuracy.
NVR	Network Video Recorder
MTU	MTU (Maximum Transmission Unit) refers to the maximum data packet amount (byte) on one lay of the communication protocol.
ONVIF	ONVIF (Open Network Video Interface Forum) is the defined general protocol for information exchange among the network video devices. It includes search device, real-time audio/video, metadata, information control ,etc.
PTZ	PTZ (Pan Tilt Zoom) refers to the PTZ all-direction movement, lens zoom, focus control.
RAID	Redundant Arrays of Independent Disks.
S.M.A.R.T	S.M.A.R.T (Self-Monitoring-Analysis and Reporting Technology) is a technical standard to detect HDD drive status and report potential problems.

<b>Glossary and Abbreviation</b>	<b>Note</b>
SVC	SVC (Scalable Video Coding) is a video encode technology. It can split the video streams to one basic layer and several enhanced layer according to the requirements. The basic layer it so provide the general video quality, frame rate, resolution, and the enhanced layer is to perfect the video quality.
VGA	VGA (Video Graphics Array) is a video transmission standard. It has high resolution, high display speed and abundant colors.
WLAN	WLAN (Wireless Local Area Networks) adopts radio frequency to realize data transmission.

## 11 Appendix 3 RAID

### 11.1 About RAID

RAID is an abbreviation for Redundant Array of Independent Disks. It is to combine several independent HDDs (physical HDD) to form a HDD group (logic HDD). Comparing with one HDD, RAID provides more storage capacity and data redundancy.

The different redundant arrays have different RAID level. Each RAID level has its own data protection, data availability and performance degree.

### 11.2 RAID Level

RAID Level	Note	Min. HDD Needed
RAID 0	RAID 0 is so called Striped storage. RAID 0 is to save the continued data fragmentation on several HDDs. It can process the read and write at the same time, so its read/write speed is N(N refers to the HDD amount of the RAID 0) rate of one HDD. RAID 0 does not have data redundant, so one HDD damage may result in data loss that cannot be restored.	2
RAID 1	It is also called Mirror or mirroring. RAID data is written to two HDDs equally, which guarantee the system reliability and can be repaired. RAID 1 read speed is almost close to the total volume of all HDDs. The write speed is limited by the slowest HDD. At the same time, the RAID 1 has the lowest HDD usage rate.it is only 50%.	2
RAID 5	RAID 5 is to save the data and the corresponding odd/even verification information to each HDD of the RAID 5 group and save the verification information and corresponding data to different HDDs. When one HDD of the RAID 5 is damaged, system can use the rest data and corresponding verification information to restore the damaged data. It does not affect data integrity.	3
RAID 6	Based on the RAID 5, RAID 6 adds one odd/even verification HDD. The two independent odd/even systems adopt different algorithm, the data reliability is very high. Even two HDDs are broken at the same time. There is no data loss risk. Comparing to RAID 5, the RAID 6 needs to allocate larger HDD space for odd/even verification information, so its read/write is even worse.	4
RAID 10	RAID 10 is a combination of the RAID 1 and RAID 0. It uses the extra high speed efficient of the RAID 0 and high data protection and restores capability of the RAID 1. It has high read/write performance and security. However, the RAID 10 HDD usage efficiency is as low as RAID 1.	4

### 11.3 RAID Capacity

Please refer to the sheet for RAID space information.

capacityN refers to the mini HDD amount to create the corresponding RAID.

RAID Level	Total Space of the N HDD
RAID 0	The total amount of current RAID group
RAID 1	Min (capacityN)
RAID 5	$(N-1) \times \text{min (capacityN)}$
RAID 6	$(N-2) \times \text{min (capacityN)}$
RAID 10	$(N/2) \times \text{min (capacityN)}$
RAID 50	$(N-2) \times \text{min (capacityN)}$
RAID 60	$(N-4) \times \text{min (capacityN)}$

## 12Appendix 4 HDD Capacity Calculation

Calculate total capacity needed by each DVR according to video recording (video recording type and video file storage time).

Step 1: According to Formula (1) to calculate storage capacity  $q_i$  that is the capacity of each channel needed for each hour, unit Mbyte.

$$q_i = d_i \div 8 \times 3600 \div 1024 \quad (1)$$

In the formula:  $d_i$  means the bit rate, unit Kbit/s

Step 2: After video time requirement is confirmed, according to Formula (2) to calculate the storage capacity  $m_i$ , which is storage of each channel needed unit Mbyte.

$$m_i = q_i \times h_i \times D_i \quad (2)$$

In the formula:

$h_i$  means the recording time for each day (hour)

$D_i$  means number of days for which the video shall be kept

Step 3: According to Formula (3) to calculate total capacity (accumulation)  $q_T$  that is needed for all channels in the DVR during **scheduled video recording**.

$$q_T = \sum_{i=1}^c m_i \quad (3)$$

In the formula:  $c$  means total number of channels in one DVR

Step 4: According to Formula (4) to calculate total capacity (accumulation)  $q_T$  that is needed for all channels in DVR during **alarm video recording (including motion detection)**.

$$q_T = \sum_{i=1}^c m_i \times a\% \quad (4)$$

In the formula:  $a\%$  means alarm occurrence rate

You can refer to the following sheet for the file size in one hour per channel. (All the data listed below are for reference only.)

Bit stream size (max.)	File size	Bit stream size (max.)	File size
96K	42M	128K	56M
160K	70M	192K	84M
224K	98M	256K	112M
320K	140M	384K	168M
448K	196M	512K	225M
640K	281M	768K	337M
896K	393M	1024K	450M
1280K	562M	1536K	675M

1792K	787M	2048K	900M
-------	------	-------	------

**Note**

- **This manual for reference only. Slight difference may be found on the user interface.**
- **All the designs and software here are subject to change without prior written notice.**
- **All trademarks and registered trademarks are the properties of their respective owners.**
- **If there is any uncertainty or controversy, please refer to the final explanation of us.**
- **Please visit our website or contact your local service engineer for more information.**

ZHEJIANG DAHUA VISION TECHNOLOGY CO.,LTD.

Address: No.1199, Bin'an Road, Binjiang District, Hangzhou, P.R. China

Postcode: 310053

Tel: +86-571-87688883

Fax: +86-571-87688815

Email:overseas@dahuatech.com

Website: www.dahuasecurity.com