

# **Dahua HD Mini IR Waterproof Bullet Network Camera**

## **Quick Start Guide**

**Version 1.0.0**

**Zhejiang Dahua Vision Technology Co., LTD**

## Welcome

Thank you for purchasing our Network camera!

This user's manual is designed to be a reference tool for your system.

Please read the following safeguard and warnings carefully before you use this series product!

Please keep this user's manual well for future reference!

## Important Safeguards and Warnings

### 1 . Electrical safety

All installation and operation here should conform to your local electrical safety codes.

Please check if the power supply is correct before operating the device.

The power shall conform to the requirement in the SELV (Safety Extra Low Voltage) and the Limited power source is rated 12V DC, DC5V or AC24V in the IEC60950-1. (Power supply requirement is subject to the device label).

Please install easy-to-use device for power off before installing wiring, which is for emergent power off when necessary.

Please prevent the line cord from being trampled or pressed, especially the plug, power socket and the junction from the device.

**Note: Do not connect these two power supplying sources to the device at the same time; it may result in device damage!**

We assume no liability or responsibility for all the fires or electrical shock caused by improper handling or installation.

We are not liable for any problems caused by unauthorized modification or attempted repair.

### 2 . Environment

Please don't aim the device at strong light (such as lighting, sunlight and so on) to focus; otherwise it may cause overexposure (It is not the device malfunction), which will affect the longevity of CCD or CMOS.

Please transport, use and store the device within the range of allowed humidity and temperature.

Please don't keep the device in a place which is wet, dusty, extremely hot, and extremely cold and with strong electromagnetic radiation or unstable lighting.

Please do not allow water and other liquid falling into the camera in case that the internal components are damaged.

Please do not allow rain or damp to the indoor device in case fire or lightning may occur.

Please keep the sound ventilation in case of heat accumulation.

Please pack the device with standard factory packaging or material with same quality when transporting the device.

Heavy stress, violent vibration or water splash are not allowed during transportation, storage and installation.

### 3. Operation and Daily Maintenance

Please do not touch the heat dissipation component of the device directly in order to avoid scald.

Please do not dismantle the device; there is no component which can be fixed by users themselves in the machine. It may cause water leakage or bad image for the device due to unprofessional dismantling. It is recommended to use the device with thunder proof device in order to improve thunder proof effect. The grounding holes of the product are recommended to be grounded to further enhance the reliability of the camera.

Do not touch the CCD (CMOS) optic component directly. You can use the blower to clean the dust or dirt on the lens surface. Please use a dry cloth wetted by alcohol to wipe away the dust gently if it is necessary to clean.

Always use the dry soft cloth to clean the device. If there is too much dust, please use the water to dilute the mild detergent first and then use it to clean the device. Finally use the dry cloth to clean the device. Don't use volatile solvent like alcohol, benzene, thinner and etc or strong detergent with abrasiveness, otherwise it will damage the surface coating or reduce the working performance of the device.

Dome cover is an optical device, please don't touch or wipe cover surface directly during installation and use, please refer to the following methods to deal with once dirt is found:

Stained with dirt

Use oil-free soft brush or hair dries to remove it gently.

Stained with grease or fingerprint

Use soft cloth to wipe the water drop or oil gently to make it dry, then use oil-free cotton cloth or paper soaked with alcohol or detergent to wipe from the lens center to outward. It is ok to change the cloth and wipe several times if it is not clean enough.

## **Warning**

Please use the standard accessories provided by manufacturer and make sure the device is installed and fixed by professional engineers.

Please prevent the device surface from the radiation of laser beam when using laser beam device.

Please do not provide two or more power supply modes for the device, otherwise it may cause damage to the device.

## **Statement**

Please refer to the actual product for more details; the manual is just for reference.

The manual will be regularly upgraded according to the product update; the upgraded content will be added in the manual without prior announcement.

Please contact the supplier or customer service if there is any problem occurred when using the device. Please contact the customer service for the latest procedure and supplementary documentation.

There may be deviation between the actual value of some data and the value provided in the manual due to the reasons such as the real environment is not stable and so on. Please refer to the company's final explanation if there is any doubt or dispute.

The company is not liable for any loss caused by the operation which is not followed by the manual.

## FCC Information

### 1. FCC conditions:

This device complies with part 15 of the FCC Rules. Operation is subject to the following two conditions:

- This device may not cause harmful interference;
- This device must accept any interference received, including interference that may cause undesired operation.

### 2. FCC compliance:

This equipment has been tested and found to comply with the limits for a digital device, pursuant to part 15 of the FCC Rules. These limits are designed to provide reasonable protection against harmful interference. This equipment generates uses and can radiate radio frequency energy and, if not installed and used in accordance with the instruction manual, may cause harmful interference to radio communication. However, there is no guarantee that interference will not occur in a particular installation. If this equipment does cause harmful interference to radio or television reception, which can be determined by turning the equipment off and on, the user is encouraged to try to correct the interference by one or more of the following measures:

- Reorient or relocate the receiving antenna.
- Increase the separation between the equipment and receiver.
- Connect the equipment into an outlet on a circuit different from that to which the receiver is connected.
- Consult the dealer or an experienced radio/TV technician for help.

### Note:

Please refer to the disk for more details, check and download corresponding user's manual and tool. Before installation, please open the package and check all the components are included. Contact your local retailer ASAP if something is broken in your package.

Accessory Name	Amount
Network Camera Unit	1
Quick Start Guide	1
Installation Accessories Bag	1
CD	1

## Table of Contents

1	Framework.....	1
1.1	Device External Cable .....	1
1.2	Framework and Dimension .....	1
2	Device Installation .....	2
2.1	Install Device.....	2
3	Network Configuration .....	4
3.1	Modify IP Address .....	4
3.2	Login WEB Interface .....	6

# 1 Framework

## 1.1 Device External Cable

You can refer to the following figure for cable information. See Figure 1-1.

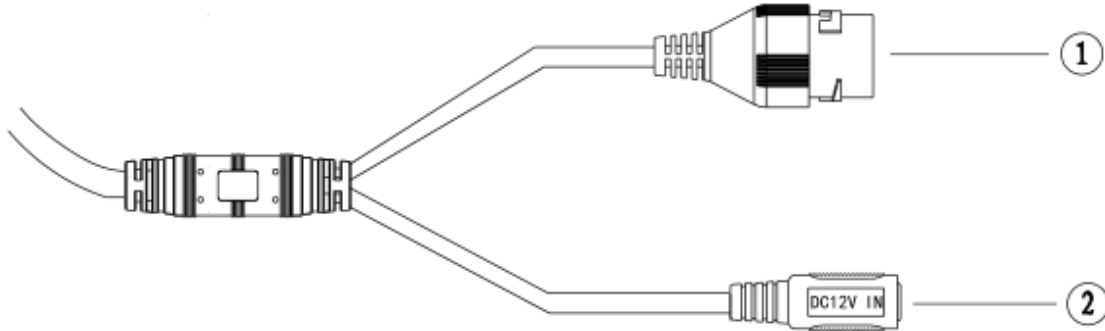

Figure 1-1 Cable

Please refer to the following sheet for detailed information.

SN	Port	Port name	Connector	Function description
1	LAN	Network port	Ethernet port	Connect to standard Ethernet cable. Note: Some devices do not support PoE power supply.
2	DC 12V	Power input port	-	Power port. Input DC 12V.

## 1.2 Framework and Dimension

The following figures are for reference only, which are used to know the device dimension, please refer to the following figure according to the actual device.

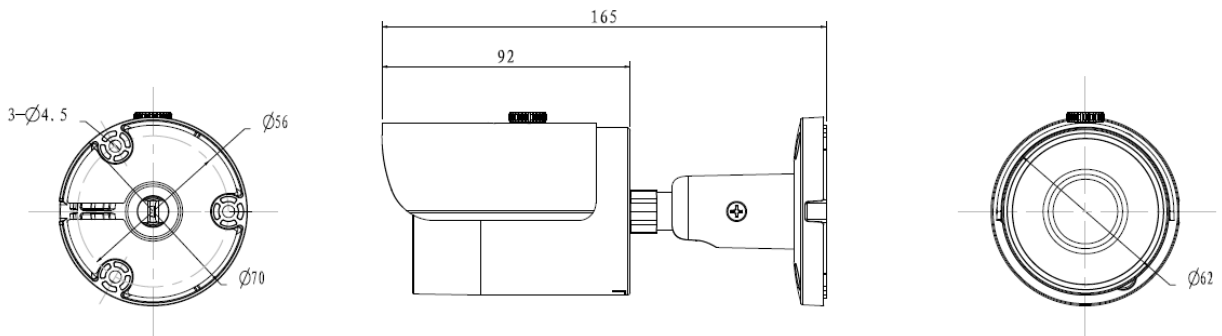

Figure 1-2

## 2 Device Installation

### Note:

- The device installation steps may be different due to the different appearance and structure, please refer to 2.1 according to the actual product.
- Please make sure the installation surface can min support the 3X weight of the camera and the bracket.

### 2.1 Install Device

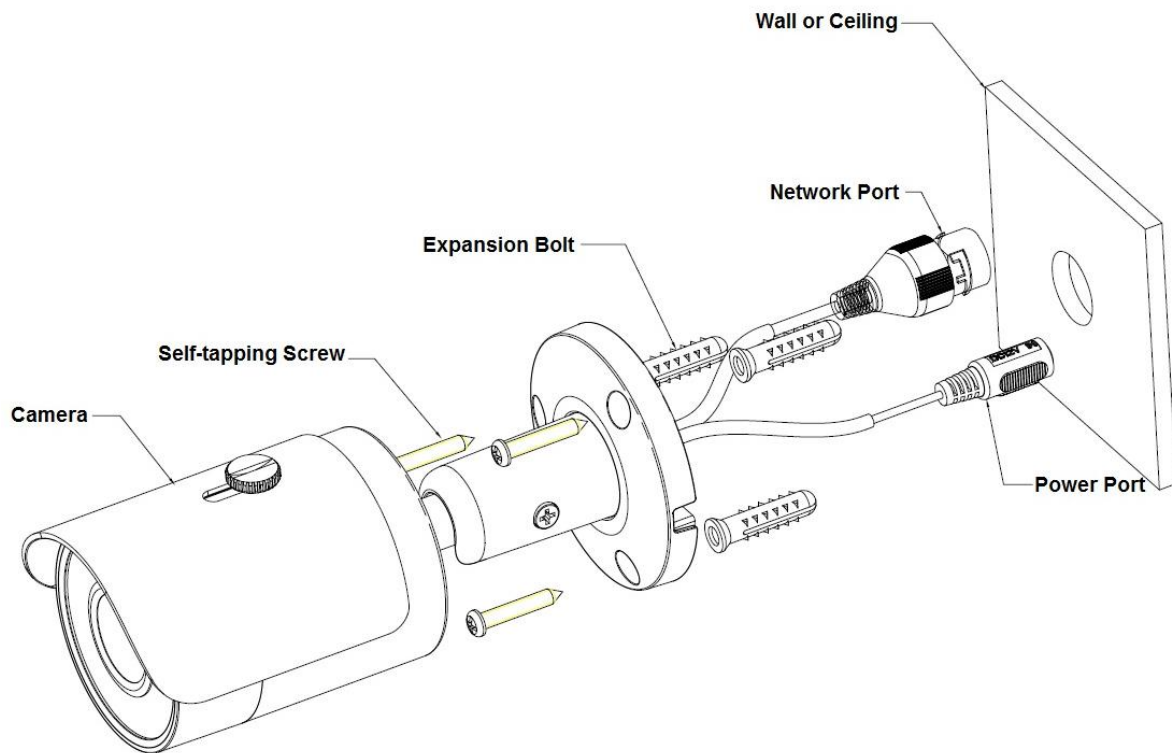

Figure 2-1

Please see Figure 2-1 and Figure 2-2.

#### Step 1

Dig holes on the installation surface (wall or ceiling).

#### Step 2

Open accessories bag, take out expansion bolt and insert it into the hole you just dug.

#### Step 3

Open accessories bag, take out installation screws. Tighten the screws to fix the device on the installation surface (wall or ceiling). You can move device sunshade back and forth. When you have fixed the device, you must tighten screws on sunshade.

#### Step 4

Plug external wiring of the device properly.

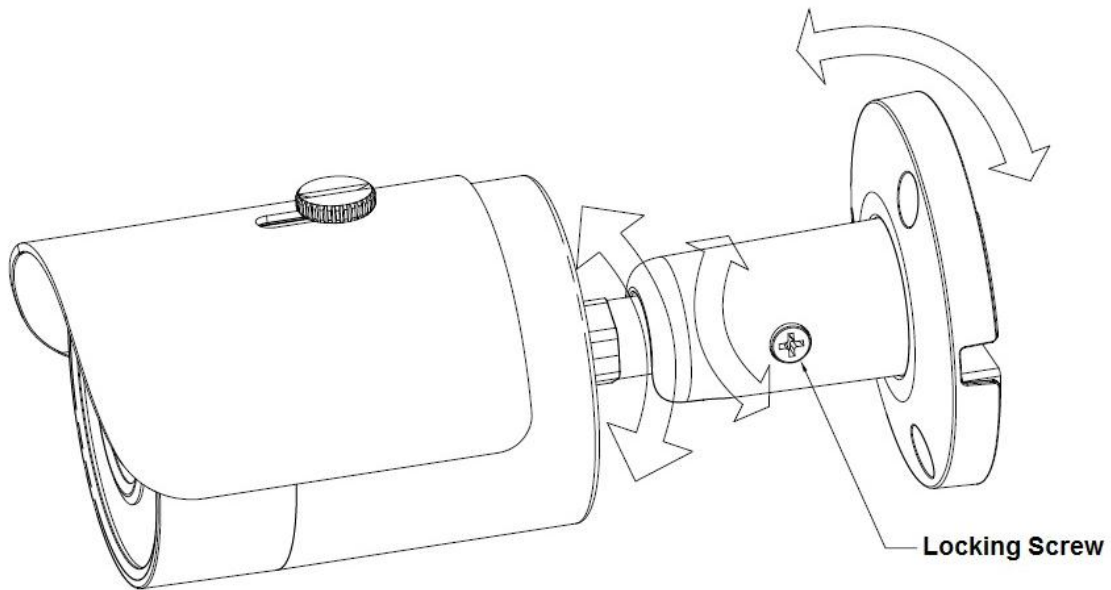

Figure 2-2

**Step 5**

Use cross screwdriver (in accessories bag) to loosen adjusting screw.

**Step 6**

Adjust the device in all possible directions, and set its monitoring direction according to the requirements.

**Step 7**

Use cross screwdriver to tighten the adjusting screws.

**Step 8**

Waterproof connector installation for network port; see Figure 2-3 for more details.

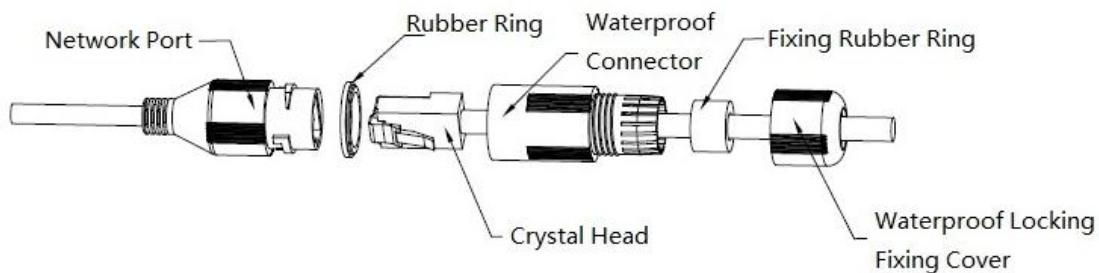

Figure 2-3

1. Keep the convex groove outward and install the rubber ring into the network port, keep the smaller hole of the rubber ring outward and install the fixing rubber ring into the main body of the waterproof connector.
2. Pull the network cable without crystal head through main body of waterproof connector, fixing rubber ring and waterproof locking cover, make the crystal head of network cable, and then insert it into the network cable.
3. Put the main body of waterproof connector on the network port and rotate it clockwise to lock the network port and waterproof connector firmly.
4. Put the waterproof locking cover on the main body of waterproof connector and rotate it clockwise to lock the waterproof connector and waterproof locking cover firmly.



## 3 Network Configuration

The IP address of all the cameras is the same when leaving factory (default IP192.168.1.108), in order to make the camera get access to the network smoothly, please plan the useable IP segment reasonably according to the actual network environment.

### 3.1 Modify IP Address

IP address can be acquired and modified through quick configuration tool for the cameras which are accessed via wired network, it needs to connect wired network to configure wireless parameters before using wireless network cameras. In this chapter, it will introduce the approach of modifying IP address via “Quick Configuration Tool”; also you can modify the IP address in the network parameters of the WEB interface, please refer to the document in the disk << WEB Operation Manual>> for more details.

**Note:**

Currently the quick configuration tool only supports the cameras which apply to the same network segment with computer IP address.

Step 1

Double click the “ConfigTools.exe” and open the quick configuration tool.

Step 2

Double click the device to be configured, the system will pop out the “Login” dialog box. Enter the IP address, user name, password and port number of the camera, and click “Confirm”.

**Note:**

The default user name and password are admin and admin respectively, the default of port is 37777. See Figure 3-1 for more details.

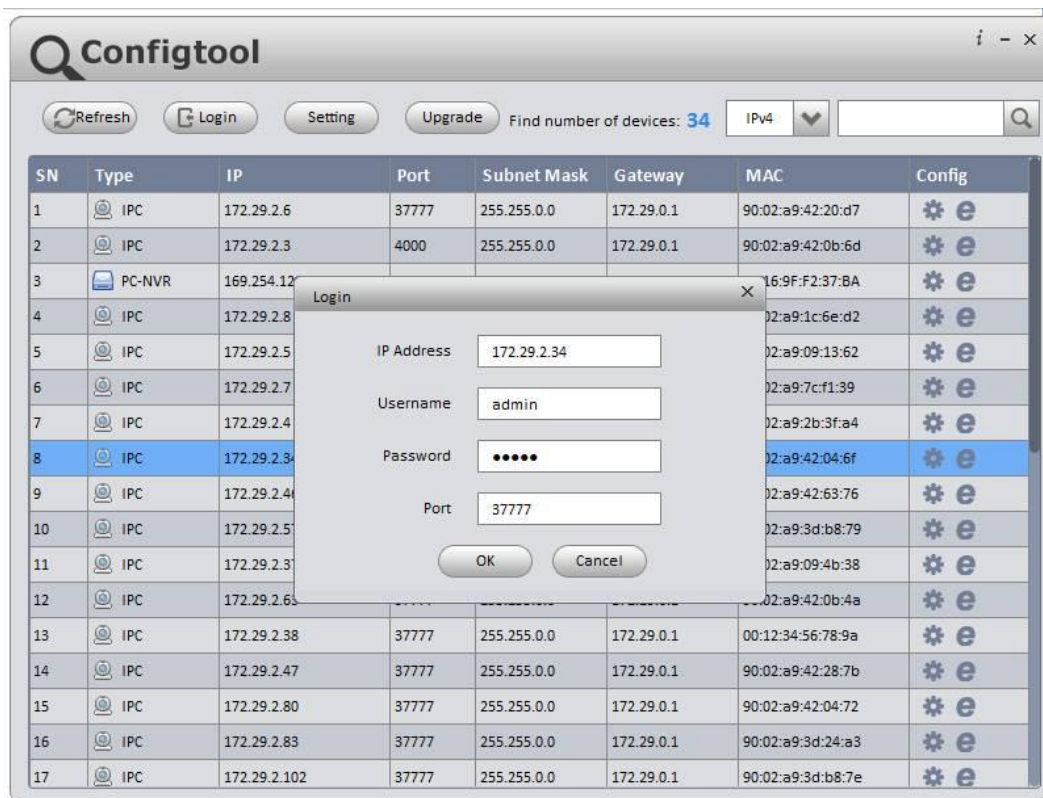

Figure 3-1

Step 3

Modify the camera IP address on the “Net” interface, click “Save” to finish modification.

See Figure 3-2 for more details.

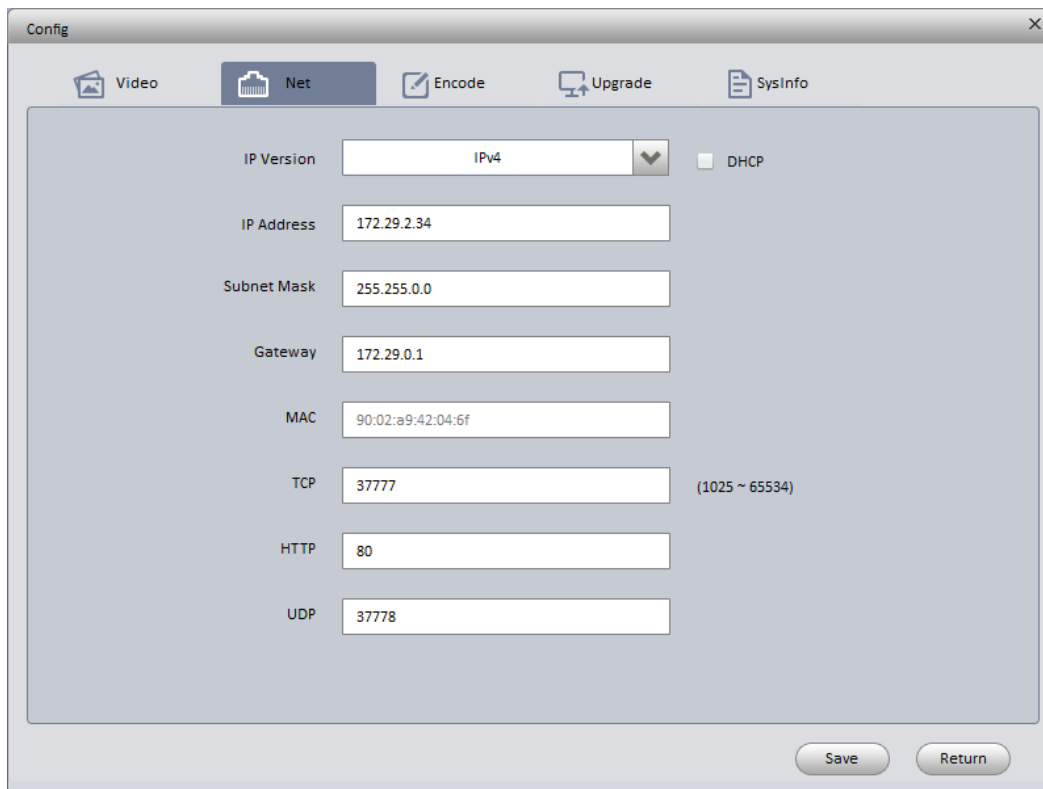

Figure 3-2

## 3.2 Login WEB Interface

Note:

Different devices may have different WEB interfaces, the figures below are just for reference, please refer to the document <<WEB Operation Manual>> in the disk and the actual interface for more details

Step 1

Open IE and input the modified camera IP address in the address bar.

Step 2

The login interface is shown below, please input your user name and password (Default user name is admin and password is admin respectively), click “login”.

See Figure 3-3 for more details.



Figure 3-3

Step 3

Install controls according to the system prompt; see Figure 3-4 for the WEB main interface.

Please modify the administrator password as soon as possible after you successfully logged in.

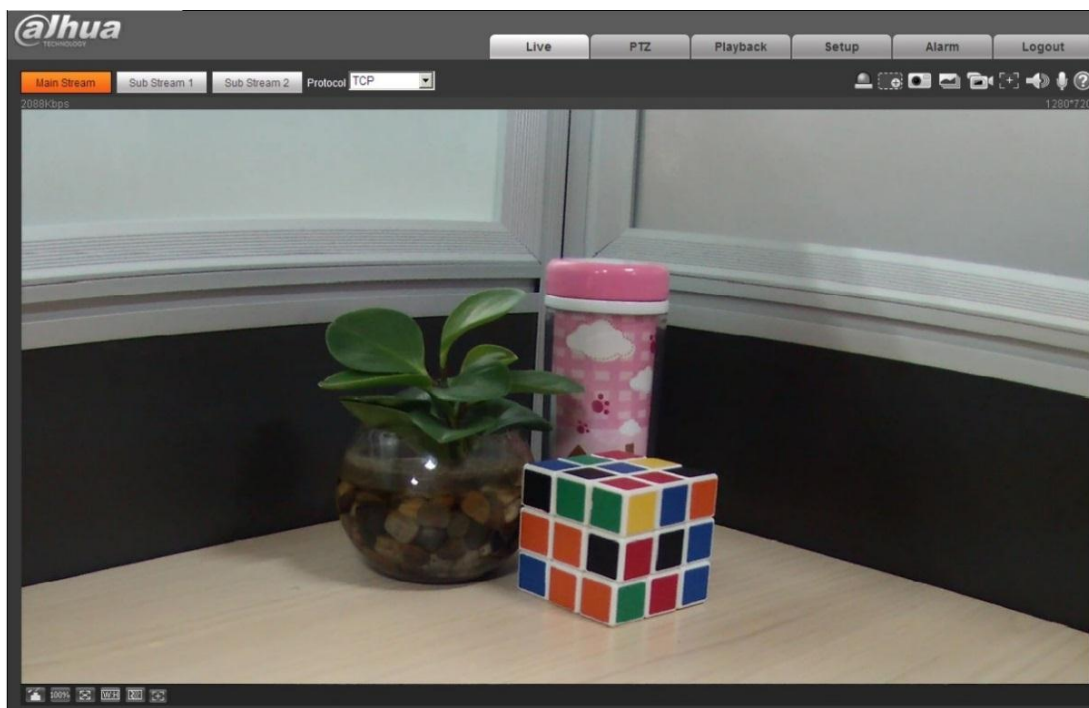

Figure 3-4

**Note:**

- This quick start guide is for reference only. Slight difference may be found in user interface.
- All the designs and software here are subject to change without prior written notice.
- If there is any uncertainty or controversy, please refer to the final explanation of us.
- Please visit our website or contact your local service engineer for more information.



**Zhejiang Dahua Vision Technology Co., Ltd**

Address: No.1199 Bin'an Road, Binjiang District, Hangzhou, PRC.

Postcode: 310053

Tel: +86-571-87688883

Fax: +86-571-87688815

Email: [overseas@dahuatech.com](mailto:overseas@dahuatech.com)

Website: [www.dahuasecurity.com](http://www.dahuasecurity.com)