

4K IR Vari-focal ePoE Dome

WDR IR Dome Network Camera



System Overview

The 4K dome camera features an advanced 1/2.5-in. STARVIS™ imager with a 2.7 mm to 12 mm vari-focal lens. The camera offers True Wide Dynamic Range, a True Day/Night IR Cut filter, IP67 Ingress Protection and operation in extreme temperatures to deliver superior images in most environmental conditions. The camera is a component of Dahua's innovative Enhanced Power over Ethernet (ePoE) system that transmits power and data over long distances without the need for repeaters or multiple switches.

Functions

Enhanced Power over Ethernet (ePoE) Technology

Dahua's innovative ePoE technology offers a plug-and-play solution to transmit power and data over long distances via Ethernet or coaxial cables, reducing installation time and saving money. ePoE technology is a viable, cost-effective solution for extending transmission distances and for converting existing, coax-based analog systems into IP systems. For video security and surveillance installers, ePoE technology saves time and money by reducing overall cabling requirements, allowing for existing coax cable to be used, and minimizing the number of peripheral devices needed. For new installations, ePoE offers the ability to design long-distance applications without the need for additional repeaters.

Enhanced PoE encompasses pure IP systems where a single CAT 5 cable can carry signals up to 800 m (2624 ft), and IP/Analog hybrid systems where the technology leverages existing analog infrastructure to transmit power and data up to 1000 m (3281 ft) over RG-59 coaxial cable. Enhanced PoE is compatible with three connection modes operating over the same network simultaneously: traditional IP networks, long-distance ePoE networks and coaxial networks. ePoE technology seamlessly integrates the latest high-definition IP cameras with a coaxial infrastructure using the Ethernet over Coaxial (EoC) protocol to convert between analog and IP power and data transmissions.

- 1/2.5-in. 8 MP Progressive-scan STARVIS™ CMOS Sensor
- Dual Stream Encoding
- Smart H. 265+ and Smart H.264+ Dual Codec
- 8 MP (3840 x 2160) at 15 fps or 3 MP (2304 x 1296) at 30 fps
- 2.7 mm to 12 mm Motorized Optical Zoom Lens
- Enhanced Power and Data Transmission Distances (ePoE)
- True Wide Dynamic Range (120 dB) and True Day/Night (ICR)
- Maximum IR LED Distance 50 m (164 ft)
- IP67 Ingress Protection and IK10 Vandal Resistance
- Intelligent Video System
- Five-year Warranty*



True Wide Dynamic Range (WDR)

The camera achieves vivid images, even in the most intense contrast lighting conditions, using industry-leading wide dynamic range (WDR) technology. For applications with both bright and low lighting conditions that change quickly, True WDR (120 dB) optimizes both the bright and dark areas of a scene at the same time to provide usable video.

Intelligent Video System (IVS)

IVS is a built-in video analytic algorithm that delivers intelligent functions to monitor a scene for Tripwire violations, intrusion detection, and abandoned or missing objects. A camera with IVS quickly and accurately responds to monitoring events in a specific area. In addition to scene analytics, the camera supports face detection to quickly capture a face and upload the image to a server. The camera also offers tamper detection by recognizing a dramatic scene change and generating a warning message to inspect the camera.

Smart H.265+

Smart H.265+ is the optimized implementation of the H.265 codec that uses a scene-adaptive encoding strategy, dynamic GOP, dynamic ROI, flexible multi-frame reference structure and intelligent noise reduction to deliver high-quality video without straining the network. Smart H.265+ technology reduces bit rate and storage requirements by up to 70% when compared to standard H.265 video compression.

Environmental

Dahua cameras operate in extreme temperature environments, rated for use in temperatures from -30° C to +60° C (-22° F to +140° F) with 95% humidity. The camera complies with an IK10 impact rating making it capable of withstanding the equivalent of 5 kg (11.02 lbs) of force dropped from a height of 40 cm (15.75 in.). Subjected to rigorous dust and water immersion tests and certified to the IP67 Ingress Protection rating makes it suitable for demanding outdoor applications.

Technical Specification

Camera

Image Sensor	1/2.5-in. 8 MP Progressive-scan CMOS
Effective Pixels	3840(H) x 2160(V)
RAM/ROM	512 MB/32 MB
Scanning System	Progressive
Electronic Shutter Speed	Auto, Manual, 1/3 s to 1/100,000 s
Minimum Illumination	Color: 0.05 lux at F1.4 (1/3 s, 30 IRE) Color: 0.2 lux at F1.4 (1/30 s, 30 IRE) 0 lux at F1.4 (IR on)
S/N Ratio	More than 50 dB
IR Distance	Distance up to 50 m (164.04 ft)
IR On/Off Control	Auto, Manual
IR LEDs	Three (3)

Lens

Lens Type	Motorized, Auto Iris (DC)				
Mount Type	Board-in				
Focal Length	2.7 mm to 12 mm				
Maximum Aperture	F1.4				
Angle of View	Horizontal: 110° to 40° Vertical: 58° to 23°				
Optical Zoom	4x				
Focus Control	Motorized				
Close Focus Distance	0.30 m (0.98 ft)				
DORI ¹ Distance	Lens	Detect	Observe	Recognize	Identify
	Wide	85 m (280 ft)	34 m (112 ft)	17 m (56 ft)	8.5 m (28 ft)
	Tele	228 m (748 ft)	91 m (299 ft)	46 m (151 ft)	23 m (75 ft)

Installation Angle

Range	Pan: 0° to 355° Tilt: 0° to 65° Rotation: 0° to 355°
-------	--

Video

Compression	Smart H.265+, H.265, Smart H.264+, H.264
Streaming Capability	Three (3) Streams
Resolution	8 MP (3840 x 2160), 6 MP (3072 x 2048), 5 MP (2560 x 1920) 3 MP (2048 x 1536), 3 MP (2304 x 1296), 1080p (1920 x 1080), 1.3 MP (1280 x 960), 720p (1280 x 720), D1 (704 x 480), VGA (640 x 480), CIF (352 x 240)
Frame Rate	Main Stream: 8 MP at 15 fps or 3 MP at 30 fps
	Sub Stream 1: D1 at 30 fps Sub Stream 2: 720p at 30 fps
Bit Rate Control	CBR/VBR
Bit Rate	H.264: 24 Kbps to 10240 Kbps H.265: 14 Kbps to 9984 Kbps
Day/Night	Auto (ICR), Color, B/W
BLC Mode	BLC, HLC, True WDR (120 dB)

White Balance	Auto, Natural, Street Lamp, Outdoor, Manual
Gain Control	Auto, Manual
Noise Reduction	3D DNR
Motion Detection	Off, On (4 Zones, Rectangular)
Region of Interest	Off, On (4 Zones)
Smart IR	Support
Digital Zoom	16x
Flip	0°, 90°, 180°, 270°
Mirror	Off, On
Privacy Masking	Off, On (4 Areas, Rectangular)

Audio

Compression	G.711a, G.711Mu, AAC, G.726
-------------	-----------------------------

Network

Ethernet	RJ-45 (10/100 Base-T)
Protocol	HTTP, HTTPS, TCP, ARP, RTSP, RTP, UDP, SMTP, FTP, DHCP, DNS, DDNS, PPPOE, IPv4/v6, QoS, UPnP, NTP, Bonjour, 802.1x, Multicast, ICMP, IGMP, SNMP
Interoperability	ONVIF, PSIA, CGI
Streaming Method	Unicast / Multicast
Maximum User Access	10 Users / 20 Users
Edge Storage	Network Attached Storage (NAS) Local PC for Instant Recording Micro SD Slot, maximum 128 GB
Web Viewer	IE, Chrome, Firefox, Safari
Management Software	SmartPSS, DSS
Smart Phone	IOS, Android

Certifications

Safety	UL60950-1
Electromagnetic Compatibility (EMC)	FCC CFR 47 Part 15 Subpart B

Interface

Video	One (1) RCA Port (for installation adjustment)
Audio	Input: One (1) Channel Output: One (1) Channel
Alarm	Input: One (1) Channel (5 mA, 5 VDC) Output: One (1) Channel (300 mA, 12 VDC)

Electrical

Power Supply	12 VDC, 2 A; 24 VAC, 0.8 A; or PoE+ (IEEE802.3at, Class 4)
Power Consumption	< 15 W

1. The DORI distance is a measure of the general proximity for a specific classification to help pinpoint the right camera for your needs. The DORI distance is calculated based on sensor specifications and lab test results according to EN 62676-4, the standard that defines the criteria for the Detect, Observe, Recognize and Identify classifications.

Environmental

Operating Temperature	-30° C to +60° C (-22° F to +140° F) Less than 95% RH
Storage Temperature	-30° C to +60° C (-22° F to +140° F) Less than 95% RH
Ingress Protection	IP67
Vandal Resistance	IK10

Construction

Casing	Metal
Dimensions	ø159.10 mm x 117.90 mm (ø6.26 in. x 4.64 in.)
Net Weight	0.95 kg (2.09 lb)
Gross Weight	1.20 kg (2.65 lb)

Intelligence

IVS triggers an alarm and takes a defined action for the following events:

Standard Features	<ul style="list-style-type: none"> • Tampering with the camera. • Error writing to an onboard Micro SD card. • Error sending or receiving data over the network. • Unauthorized access to the camera.
Premium Features	
Motion	An object moves through any part of the scene.
Tripwire	A target crosses a user-defined line.
Intrusion	A target enters or exits a defined perimeter.
Scene Change	A person or object moves the camera to change the scene or covers the camera to obscure the scene.
Abandoned/Missing Object	A target leaves an object in designated area, or a target removes an object from the same designated area.

ePoE Transmission Distances

Via CAT5E/CAT6 Ethernet Cable

ePoE supply voltage 48 V
Maximum DC resistance < 10 Ω/100 m

Cable Length, m (ft)	Bandwidth, Mbps	PoE Load Capacity, W	Hi-PoE Load Capacity, W	Working Mode
100 (328)	100	25.5	53	IEEE/E100
200 (656)	100	25.5	33	E100
300 (984)	100	19	19	E100
400 (1312)	10	17	17	E10
500 (1640)	10	13	13	E10
800 (2625)	10	7	7	E10

Via CAT5E/CAT6 Ethernet Cable

ePoE supply voltage 53 V
Maximum DC resistance < 10 Ω/100 m

Cable Length, m (ft)	Bandwidth, Mbps	PoE Load Capacity, W	Hi-PoE Load Capacity, W	Working Mode
100 (328)	100	25.5	53	IEEE/E100
200 (656)	100	25.5	47	E100
300 (984)	100	25.5	32	E100
400 (1312)	10	23	26	E10
500 (1640)	10	20	20	E10
800 (2625)	10	13	13	E10

Via RG-59 Coaxial Cable

ePoE supply voltage 48 V
Maximum DC resistance < 5 Ω/100 m

Cable Length, m (ft)	Bandwidth, Mbps	PoE Load Capacity, W	Hi-PoE Load Capacity, W	Working Mode
100 (328)	100	25.5	50	IEEE/E100
200 (656)	100	25.5	30	E100
300 (984)	100	18	18	E100
400 (1312)	100	15	15	E100
500 (1640)	10	12	12	E10
800 (2625)	10	6	6	E10
1000 (3281)	10	5	5	E10



Via RG-59 Coaxial Cable

ePoE supply voltage 53 V
Maximum DC resistance < 5 Ω/100 m

Cable Length, m (ft)	Bandwidth, Mbps	PoE Load Capacity, W	Hi-PoE Load Capacity, W	Working Mode
100 (328)	100	25.5	52	IEEE/E100
200 (656)	100	25.5	48	E100
300 (984)	100	25.5	30	E100
400 (1312)	100	20	23	E100
500 (1640)	10	16	16	E10
800 (2625)	10	10	10	E10
1000 (3281)	10	8	8	E10

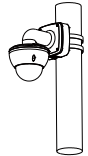
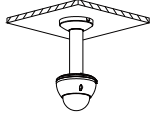
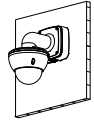

Ordering Information		
Type	Part Number	Description
4K Network Camera	N85CL5Z	8 MP IR ePoE, Vari-focal Dome Network Camera, True WDR, IVS
Mounting Accessories, optional	PFA101	Mount Adapter
	PFA138	Junction Box
	PFA152-E	Pole Mount
	PFB201C	In-ceiling Mount
	PFB300C	Ceiling Mount
	PFB302S	Wall Mount
	DH-PFM320D-015	12 VDC, 2 A Power Adapter
	HKKD-11108	24 VAC, 1.5 A Power Adapter
ePoE Accessories, optional	LR1002	EoC Passive Converter
	LR1002-1EC	Single-port EoC Receiver

In-ceiling Mount	Junction Mount	Pole Mount
PFB201C	PFA138	PFA101 + PFB302S + PFA152-E
		
Ceiling Mount	Wall Mount	
PFA101 + PFB300C	PFA101 + PFB302S	
		

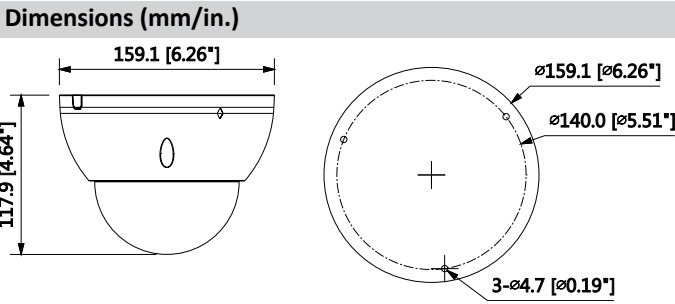

Accessories

Optional:



PFA101
Mount Adapter



PFA138
Junction Box



PFB302S
Wall Mount



PFA152-E
Pole Mount



PFB201C
In-ceiling Mount



PFB300C
Ceiling Mount



DH-PFM320D-015
Power Adapter



HKKD-11108
Power Adapter



LR1002
EoC Passive Converter



LR1002-1EC
Single-port EoC Receiver

