

# Standalone DVR Quick Start Guide

## Table of Contents

1	Hardware Installation and Connection.....	1
1.1	Check Unpacked DVR.....	1
1.2	About Front Panel and Rear Panel.....	1
1.3	After Remove the Chassis.....	1
1.4	HDD Installation .....	1
1.4.1	HDD Calculation.....	1
1.4.2	HDD Installation .....	2
1.5	Rack Installation.....	4
1.6	Front Panel .....	4
1.7	Rear Panel.....	4
1.8	Connection Sample .....	5
1.9	Alarm Input and Output Connection .....	5
1.9.1	Alarm Input and Output Details .....	6
1.9.2	Alarm Input Port .....	7
1.9.3	Alarm Output Port.....	7
2	Overview of Navigation and Controls.....	9
2.1	Boot up .....	9
2.2	Device Initialization.....	9
2.3	Reset Password.....	11
2.4	Quick Settings .....	17
2.5	Network .....	19
2.6	P2P .....	20
2.7	Registration.....	22
2.8	Record Control .....	25

2.9	Schedule .....	26
2.10	Preview .....	27
2.11	Playback .....	28
2.11.1	Instant Playback .....	28
2.11.2	Historical Search & Playback .....	29
2.12	PTZ .....	30
2.12.1	PTZ Setup .....	30
2.12.2	PTZ Operation .....	31
2.12.3	Call OSD Menu .....	32
2.13	Channel Type .....	33
2.14	Shut Down .....	34
3	Web Operation .....	36
3.1	Network Connection .....	36
3.2	Login .....	36
3.3	Main Window .....	37
3.3.1	LAN Login .....	37
3.3.2	WAN Login .....	37

# Welcome

Thank you for purchasing our DVR!

This quick start guide will help you become familiar with our DVR in a very short time.

Before installation and operation, please read the following safeguard and warning carefully!

## Regulatory Information

### FCC Information



Changes or modifications not expressly approved by the party responsible for compliance could void the user's authority to operate the equipment.

#### FCC conditions:

This device complies with part 15 of the FCC Rules. Operation is subject to the following two conditions:

- This device may not cause harmful interference.
- This device must accept any interference received, including interference that may cause undesired operation.

#### FCC compliance:

This equipment has been tested and found to comply with the limits for a digital device, pursuant to part 15 of the FCC Rules. This equipment generate, uses and can radiate radio frequency energy and, if not installed and used in accordance with the guide, may cause harmful interference to radio communication.

- For class A device, these limits are designed to provide reasonable protection against harmful interference in a commercial environment. Operation of this equipment in a residential area is likely to cause harmful interference in which case the user will be required to correct the interference at his own expense.
- For class B device, these limits are designed to provide reasonable protection against harmful interference in a residential installation. However, there is no guarantee that interference will not occur in a particular installation. If this equipment does cause harmful interference to radio or television reception, which can be determined by turning the equipment off and on, the user is encouraged to try to correct the interference by one or more of the following measures:
  - Reorient or relocate the receiving antenna.
  - Increase the separation between the equipment and receiver.
  - Connect the equipment into an outlet on a circuit different from that to which the receiver is connected.
  - Consult the dealer or an experienced radio/TV technician for help.

# Important Safeguard and Warning

## 1 . Electrical safety

All installation and operation here should conform to your local electrical safety codes.

The product must be grounded to reduce the risk of electric shock.

Please use three-pin power socket (with GND).

An apparatus with CLASS I construction shall be connected to a MAINS socket outlet with a protective earthing connection.

Use a power supply which meets the requirements for SELV (Safety Extra Low Voltage) and complies with Limited Power Source according to IEC 60950-1. Refer to the device label for detailed information.

We assume no liability or responsibility for all the fires or electrical shock caused by improper handling or installation.

## 2 . Transportation security

Heavy stress, violent vibration or water splash are not allowed during transportation, storage and installation.

## 3 . Installation

Keep upwards. Handle with care.

Do not apply power to the DVR before completing installation.

Do not place objects on the DVR.

## 4 . Qualified engineers needed

All the examination and repair work should be done by the qualified service engineers.

We are not liable for any problems caused by unauthorized modifications or attempted repair.

## 5 . Environment

The DVR should be installed in a cool, dry place away from direct sunlight, inflammable, explosive substances and etc.

This series product shall work in the specified environment.

## 6. Accessories

Be sure to use all the accessories recommended by manufacturer.

Before installation, please open the package and check all the components are included:

Contact your local retailer ASAP if something is missing in your package.









## 7. Lithium battery

Improper battery use may result in fire, explosion, or personal injury!

When replace the battery, please make sure you are using the same model!

**RISK OF EXPLOSION IF BATTERY IS REPLACED BY AN INCORRECT TYPE.  
DISPOSE OF USED BATTERIES ACCORDING TO THE INSTRUCTIONS.**

## Safety Instruction

Icon	Note
 DANGER	Indicates a hazard with a high level of risk, which if not avoided, will result in death or serious injury.
 WARNING	Indicates a hazard with a middle or low level of risk, which if not avoided, could result in personnel slightly or middle injury.
 CAUTION	Indicates a potentially hazardous situation, which if not avoided, could result in device damage, data loss, performance degradation, or unexpected results.
 Anti-static	Indicates it is the static sensitive device.
 Electric shock risk	Indicates presence of dangerous high voltage. There is a risk of electric shock to persons.
 High power laser radiation risk	Indicates presence of high power laser radiation.
 <b>Tips</b>	It is intended to help you to fix a problem or save your time.
 <b>Note</b>	Provides additional information to emphasize or supplement important points of the main text.

## Privacy Protection Notice

As the device user or data controller, you might collect personal data of others, such as face, fingerprints, car plate number, Email address, phone number, GPS and so on. You need to be in compliance with the local privacy protection laws and regulations to protect the legitimate rights and interests of other people by implementing measures including but not limited to: providing clear and visible identification to inform data subject the existence of surveillance area and providing related contact.

## About the Manual

- The Manual is for reference only. If there is inconsistency between the Manual and the actual product, the actual product shall prevail.
- We are not liable for any loss caused by the operations that do not comply with the Manual.
- The Manual would be updated according to the latest laws and regulations of related regions. For detailed information, see the paper User's Manual, CD-ROM, QR code or our official website. If there is inconsistency between paper User's Manual and the electronic version, the electronic version shall prevail.
- All the designs and software are subject to change without prior written notice. The product updates might cause some differences between the actual product and the Manual. Please contact the customer service for the latest program and supplementary documentation.
- There still might be deviation in technical data, functions and operations description, or errors in print. If there is any doubt or dispute, please refer to our final

explanation.

- Upgrade the reader software or try other mainstream reader software if the Guide (in PDF format) cannot be opened.
- All trademarks, registered trademarks and the company names in the Manual are the properties of their respective owners.
- Please visit our website, contact the supplier or customer service if there is any problem occurred when using the device.
- If there is any uncertainty or controversy, please refer to our final explanation.

# 1 Hardware Installation and Connection

## Note

All the installation and operations here should conform to your local electric safety rules.

## 1.1 Check Unpacked DVR

When you receive the DVR from the forwarding agent, please check whether there is any visible damage. The protective materials used for the package of the DVR can protect most accidental clashes during transportation. Then you can open the box to check the accessories.

Please check the items in accordance with the list. (Remote control is optional). Finally you can remove the protective film of the DVR.

## Note

Remote control is not a standard accessory and it is not included in the accessory bag.

## 1.2 About Front Panel and Rear Panel

For detailed information of the function keys in the front panel and the ports in the rear panel, please refer to the *User's Manual*.

The model label in the front panel is very important; please check according to your purchase order.

The label in the rear panel is very important too. Usually we need you to represent the serial number when we provide the service after sales.

## 1.3 After Remove the Chassis

Please check the data cable, power cable, COM cable and main board cable connection is secure or not.

## 1.4 HDD Installation

### 1.4.1 HDD Calculation

Calculate total capacity needed by each DVR according to video recording (video recording type and video file storage time).

Step 1: According to Formula (1) to calculate storage capacity  $q_i$  that is the capacity of each channel needed for each hour, unit Mbyte.

$$q_i = d_i \div 8 \times 3600 \div 1024 \quad (1)$$

In the formula:  $d_i$  means the bit rate, unit Kbit/s

Step 2: After video time requirement is confirmed, according to Formula (2) to calculate the storage capacity  $m_i$ , which is storage of each channel needed unit Mbyte.

$$m_i = q_i \times h_i \times D_i \quad (2)$$



In the formula:

$h_i$  means the recording time for each day (hour)

$D_i$  means number of days for which the video shall be kept

Step 3: According to Formula (3) to calculate total capacity (accumulation)  $q_T$  that is needed for all channels in the DVR during **scheduled video recording**.

$$q_T = \sum_{i=1}^c m_i \quad (3)$$

In the formula:  $c$  means total number of channels in one DVR

Step 4: According to Formula (4) to calculate total capacity (accumulation)  $q_T$  that is needed for all channels in DVR during **alarm video recording (including motion detection)**.

$$q_T = \sum_{i=1}^c m_i \times a\% \quad (4)$$

In the formula:  $a\%$  means alarm occurrence rate

You can refer to the following sheet for the file size in one hour per channel. (All the data listed below are for reference only.)

Bit stream size (max)	File size	Bit stream size (max)	File size
96Kbps	42MB	128Kbps	56MB
160Kbps	70MB	192Kbps	84MB
224Kbps	98MB	256Kbps	112MB
320Kbps	140MB	384Kbps	168MB
448Kbps	196MB	512Kbps	225MB
640Kbps	281MB	768Kbps	337MB
896Kbps	393MB	1024Kbps	450MB
1280Kbps	562MB	1536Kbps	675MB
1792Kbps	787MB	2048Kbps	900MB
3072Kbps	1350MB	4096Kbps	1800MB
6144Kbps	2700MB	8192Kbps	3600MB



#### Note

- All information listed in the above sheet for reference only. We are not reliable for any damage or loss resulting from it.
- For the space marked by the HDD manufacturer, 1K=1000, while for the computer OS, 1K=1024Bytes. So, the space recognized by the computer system is less than the marked space on the HDD. Please pay attention to it.
- All HDD space marked by the HDD manufacturer is shown as below: 1TB=1000GB, 1GB=1000MB, 1MB=1000KB, 1KB=1000Bytes.
- All HDD space marked by the HDD manufacturer shall become the computer OS space after the corresponding calculation. For example:
- 1TB(marked by the HDD manufacturer)=1000GB/ (1.024\*1.024\*1.024) =931GB(OS space), 500GB=500GB/(1.024\*1.024\*1.024)=465GB.

#### 1.4.2 HDD Installation



## WARNING

- Shut down the device and unplug the power cable before you install the HDD.
- Always use the HDD for the surveillance product recommended by the manufacturer.
- All figures listed below for reference only. Slight difference may be found on the front or rear panel.
- Please note the following contents are based on our 2U/3U series product. For detailed operation instruction of other series products, please refer to the User's Manual.

You can refer to the User's Manual for recommended HDD brand. Please follow the instructions below to install hard disk. This series DVR max supports 8 SATA HDDs. Please use HDD of 7200rpm or higher.



- ① Loosen the screws of the upper cover and remove the cover.



- ② Fix the HDD on the bracket. If you want to install the HDD on the bottom bracket, you need to remove the top bracket first.



- ③ Connect one end of the HDD data cable to one HDD.



- ④ Connect the other end of the HDD data cable to the mainboard.



- ⑤ Connect the power cable to the HDD.



- ⑥ Put the cover back and then fix.



### Note

- You can connect the HDD data cable and the power cable first and then fix the HDD in the device.
- Please pay attention to the front cover. It adopts the vertical sliding design. You need to push the clip first and then put down.

## 1.5 Rack Installation

Please note this installation mode is for 1.5U/2U series product.

Please follow the steps listed below.

- Use twelve screws to fix the unit
- Please make sure the indoor temperature is below 35°C (95°F).
- Please make sure there is 15cm (6 inches) space around the device to guarantee sound ventilation.
- Please install from the bottom to the top.
- If there are more accessories connected in the rack, please take precaution measures in case the rack power is overload.

## 1.6 Front Panel

For detailed operation instruction, please refer to the User's Manual.

## 1.7 Rear Panel

Please note the following contents are based on our 2U series product. For detailed operation instruction of other series products, please refer to the User's Manual.

This series DVR rear panel is shown as below. See Figure 1-1.

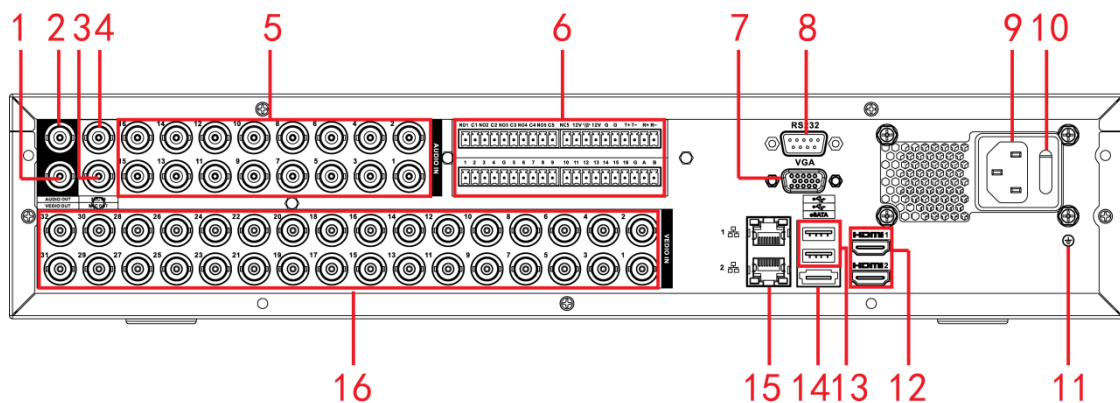

Figure 1-1

Please refer to the following sheet for detailed information.

1. Video output	2. Audio output	3. Bidirectional talk output	4. Bidirectional talk input
5. Audio input	6. Alarm input/alarm output	7. Video VGA output	8. RS-232 port
9. Power socket	10. Power switch	11. GND	12. HDMI port
13. USB port	14. eSATA port	15. Network port	16. Video input



## Important

When connect the Ethernet port, please use crossover cable to connect the PC and use the straight cable to connect to the switch or router.

## 1.8 Connection Sample

Please note the following contents are based on our 2U series product. For detailed operation instruction of other series products, please refer to the User's Manual.

Please refer to Figure 1-2 for connection sample.

The following figure is based on the 16-channel series product.

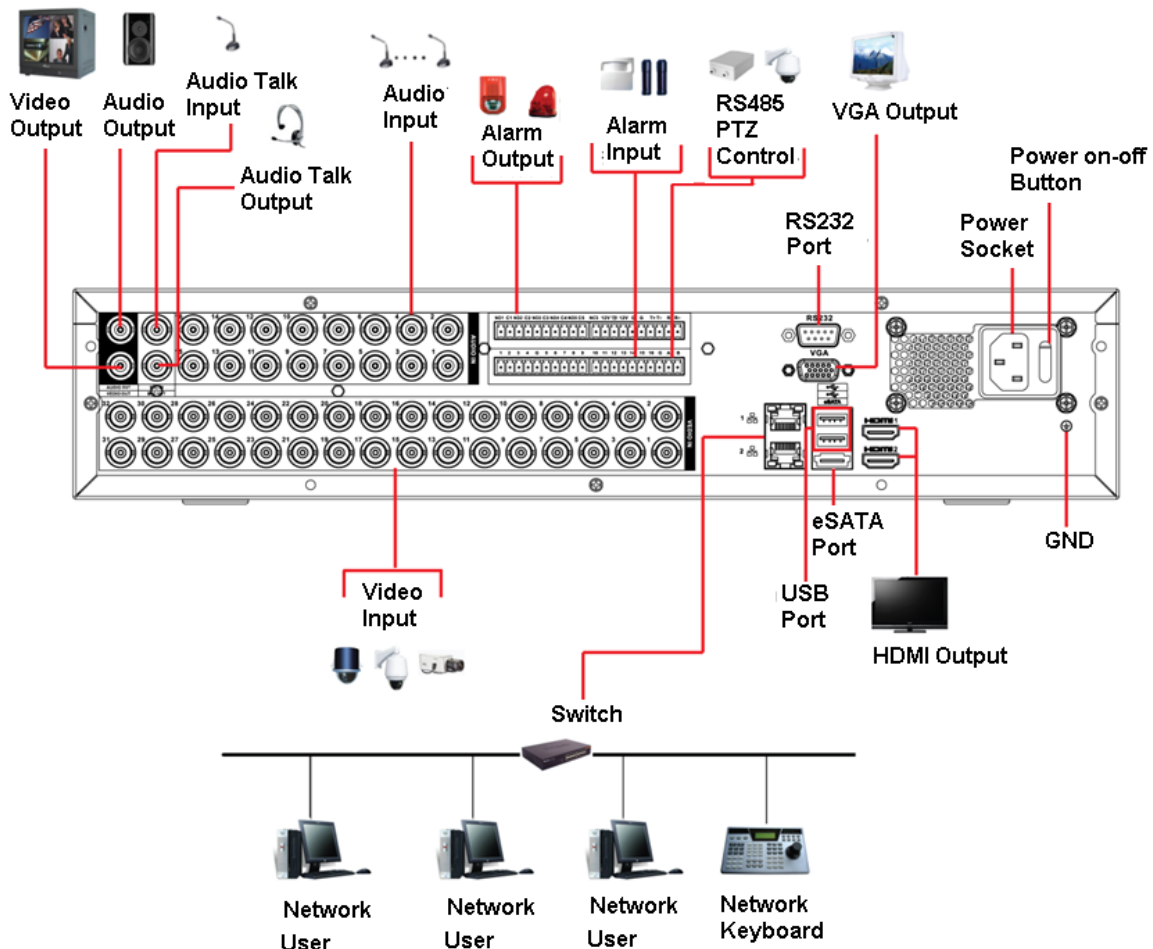

Figure 1-2

## 1.9 Alarm Input and Output Connection

Please read the followings before connecting.

### 1. Alarm input

- Please make sure alarm input mode is grounding alarm input.
- Grounding signal is needed for alarm input.
- Alarm input needs the low level voltage signal.
- Alarm input mode can be either NC (normal Open) or NO (Normal Close)

e. When you are connecting two DVRs or you are connecting one DVR and one other device, please use a relay to separate them,

## 2. Alarm output

The alarm output port should not be connected to high power load directly (It shall be less than 1A) to avoid high current which may result in relay damage. Please use the co contactor to realize the connection between the alarm output port and the load.

## 3. How to connect PTZ decoder

- Ensure the decoder has the same grounding with DVR, otherwise you may not control the PTZ. Shielded twisted wire is recommended and the shielded layer is used to connect to the grounding.
- Avoid high voltage. Ensure proper wiring and some thunder protection measures.
- For too long signal wires, 120Ω should be parallel connected between A, B lines on the far end to reduce reflection and guarantee the signal quality.
- “485 A, B” of DVR cannot parallel connect with “485 port” of other device.
- The voltage between of A,B lines of the decoder should be less than 5v.

## 4. Please make sure the front-end device has soundly earthed.

Improper grounding may result in chip damage.

### 1.9.1 Alarm Input and Output Details

You can refer to the following sheet for alarm input and output information.

#### Important

The general 2U series product interface is shown as in Figure 1-3.

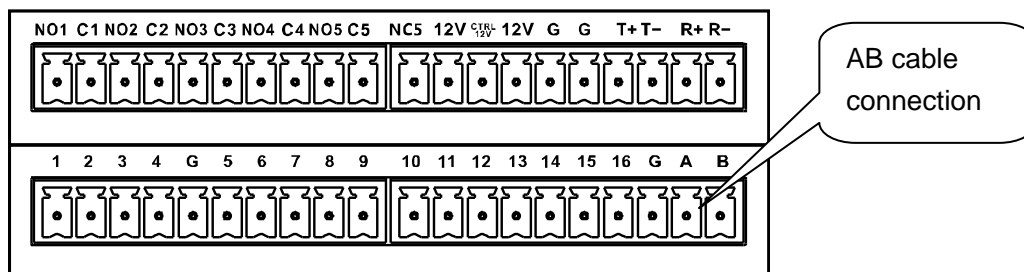



Figure 1-3

You can refer to the following sheet for alarm input and output information.

1, 2, 3, 4, 5, 6, 7, 8, 9, 10, 11, 12, 13, 14, 15, 16	ALARM 1 to ALARM 16. The alarm becomes active in low voltage.
NO1 C1, NO2 C2, NO3 C3, NO4 C4, NO5 C5 NC5	The first four are four groups of normal open activation output (on/off button) NO5 C5 NC5 is a group of NO/NC activation output (on/off button)
CTRL 12V	Control power output. The power output is off when the alarm is canceled.
+12V	It is rated power output.
	Earth cable.

485 A/B	485 communication port. They are used to control devices such as PTZ. Please parallel connect 120TΩ between A/B cables if there are too many PTZ decoders.
T+,T-,R+,R-	They are four-wire double duplex RS485 port T+ T-: output wire R+ R-: input wire

### 1.9.2 Alarm Input Port

Please refer to the following sheet for more information.

- Normal open or Normal close type.
- Please parallel connect COM end and GND end of the alarm detector (Provide external power to the alarm detector).
- Use the controllable +12V power to reset the smoke sensor remotely.
- Please parallel connect the Ground of the DVR and the ground of the alarm detector.
- Please connect the NC port of the alarm sensor to the DVR alarm input(ALARM)
- Use the same ground with that of DVR if you use external power to the alarm device.

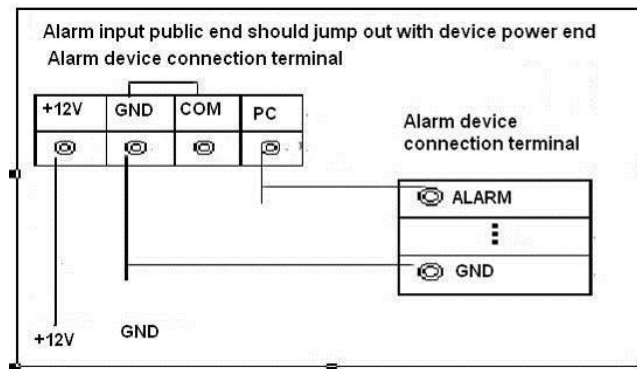

Figure 1-4

### 1.9.3 Alarm Output Port

- Provide external power to external alarm device.
- For controllable +12V, it can be used to provide power to devices such as reset smoke sensor.
- To avoid overloading, please read relay parameters sheet in the *User's Manual* carefully.
- RS485 A/B cable is for the A/B cable of the PTZ decoder.

#### Relay Specification

Model		HFD23/005-1ZS	HRB1-S-DC5V
Material of the touch		AgNi+ gold-plating	AuAg10/AgNi10/CuNi30
Rating (Resistance Load)	Rated switch capacity	30V DC 1A/125V AC 0.5A	24V DC 1A/125V AC 2A
	Maximum switch power	62.5VA/30W	250VA/48W
	Maximum switch voltage	125V AC/60V DC	125V AC/60V DC
	Maximum switch current	2A	2A
Insulation	Between touches	400VAC 1 minute	500VAC 1 minute
	Between touch and winding	1000VAC 1 minute	1000VAC 1 minute
Turn-on Time		5ms max	5ms max

Model		HFD23/005-1ZS	HRB1-S-DC5V
Turn-off Time		5ms max	5ms max
Longevity	Mechanical	$1 \times 10^7$ times ( 300 times/MIN)	$5 \times 10^6$ times ( 300 times/MIN)
	Electrical	$1 \times 10^5$ times ( 30 times/MIN)	$2.5 \times 10^4$ times ( 30 times/MIN)
Working Temperature		-30°C ~ +70°C	-40°C ~ +70°C

## 2 Overview of Navigation and Controls

Please note the following figures for reference only. For detailed operation instruction, please refer to the User's Manual.

Before operation, please make sure:

- You have properly installed HDD and all the cable connections.
- The provided input power and the device power are matched.
- Always use the stable current, if necessary UPS is a best alternative measure.

### 2.1 Boot up

Please follow the steps listed below to boot up the device.

- Connect the device to the monitor and then connect a mouse.
- Connect power cable.
- Click the power button at the front or rear panel and then boot up the device. After device booted up, the system is in multiple-channel display mode by default.

### 2.2 Device Initialization

If it is your first time to use the device, please set a login password of **admin** (system default user).

#### Note

For your device safety, please keep your login password of **admin** well after the initialization steps, and change the password regularly.

Please follow the steps listed below.

Step 1 Boot up device.

Device displays device initialization interface. See Figure 2-1.



Device Initialization

1 Enter Password    2 Unlock Pattern    3 Password Protection

User: admin

Password:

Use a password that has 8 to 32 characters, it can be a combination of letter(s), number(s) and symbol(s) with at least two kinds of them. (please do not use special symbols like ' ' ; : & )

Confirm Password:

Prompt Question:

Next

Figure 2-1



Step 2 Set login password of **admin**.

- User name: The default user name is **admin**.
- Password/confirm password: The password ranges from 8 to 32 digitals. It can contain letters, numbers and special characters (excluding “”, “”, “;”, “:”, “&”). The password shall contain at least two categories. Usually we recommend the strong password.
- Prompt question: If you set the prompt question here. On the login interface, click , device can display the corresponding prompt question for you to remind the password.



**WARNING**

**STRONG PASSWORD RECOMMENDED-For your device own safety, please create a strong password of your own choosing. We also recommend you change your password periodically especially in the high security system.**

Step 3 Click Next, device goes to the following interface. See Figure 2-2.

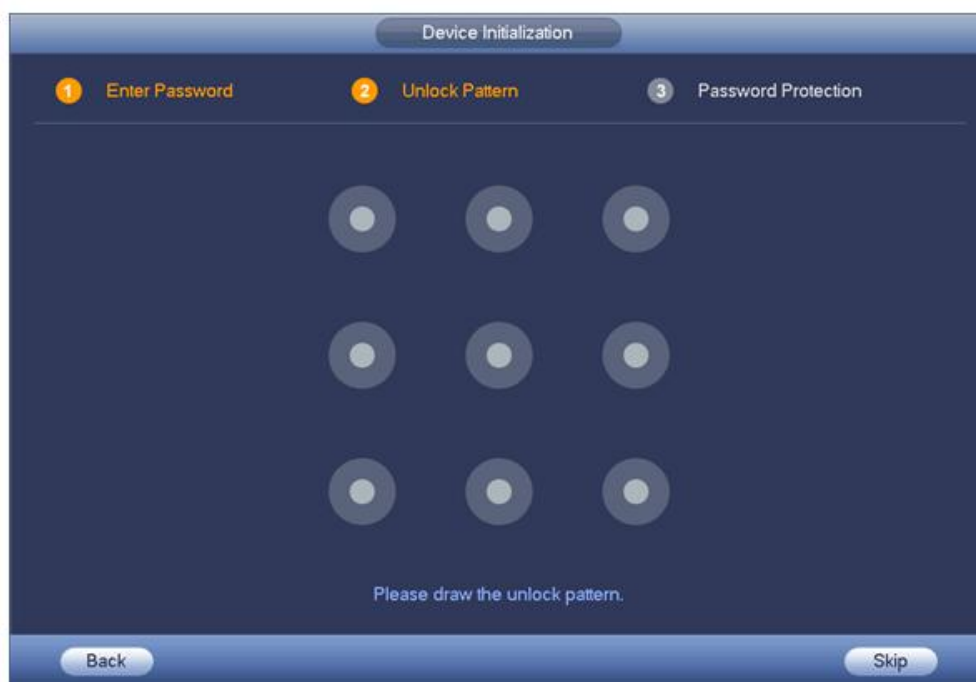

Figure 2-2

Step 4 Set unlock pattern.

After set unlock pattern, device goes to password protection interface. See Figure 2-3.



**Note**

- The unlock pattern shall at least contain 4 grids.
- Device adopts unlock pattern to login by default if you have set pattern here. If there is no unlock pattern, please input the password to login.
- Click Skip if there is no need to set unlock pattern.

Figure 2-3

Step 5 Set security questions.

 **Note**

- After setting the security questions here, you can use the email you input here or answer the security questions to reset admin password. Refer to chapter 2.3 Reset password for detailed information.
- Cancel the email or security questions box and then click Next button to skip this step.
- Email: Input an email address for reset password purpose. In case you forgot password in the future, input the security code you got on the assigned email to reset the password of admin. If you have not input email here or you need to update the email information, please go to the main menu->Setting->System->Account to set. Refer to user's manual for detailed information.
- Security question: Set security questions and corresponding answers. Properly answer the questions to reset admin password. In case you have not input security question here or you need to update the security question information, please go to the main menu->Setting->System->Account->Security question to set. Refer to user's manual for detailed information.

Step 6 Click OK to complete the device initialization setup.

Device goes to startup wizard interface. Refer to chapter 2.4 Quick Settings for detailed information.

## 2.3 Reset Password

If you forgot **admin** login password, there are two ways for you to reset password:

- When password reset function is enabled, scan the QR code on the user interface and use the email to reset password.

- When the password reset function is disabled, answer the security questions to reset password. If you have not set security questions, system pops up “Password reset function has been disabled” dialogue box, please use the Reset button on the mainboard to restore factory default settings.

Please follow the steps listed below.

Step 1 Go to the device login interface. See Figure 2-4 or Figure 2-5. .

- If you have set unlock pattern, device displays unlock pattern login interface. See Figure 2-4. Click “Forgot unlock pattern”, device goes to Figure 2-5.
- If you have not set unlock pattern, device displays password interface. See Figure 2-5.

 **Note**

Click Switch user button in Figure 2-4 or click the user name in Figure 2-5 and then select a user from the dropdown list, you can login via other account.

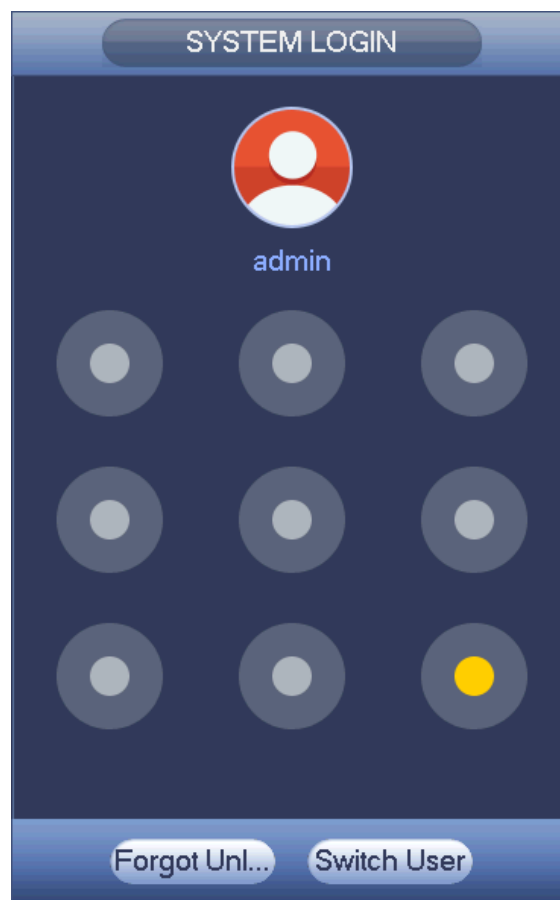



Figure 2-4



Figure 2-5

Step 2 Click  or click Forgot password on the login interface (Figure 2-5).

- If you have input email when you are initializing the device, device goes to Figure 2-6.
- If you have not input email address information when you are initializing the device, the interface is shown as in Figure 2-7.

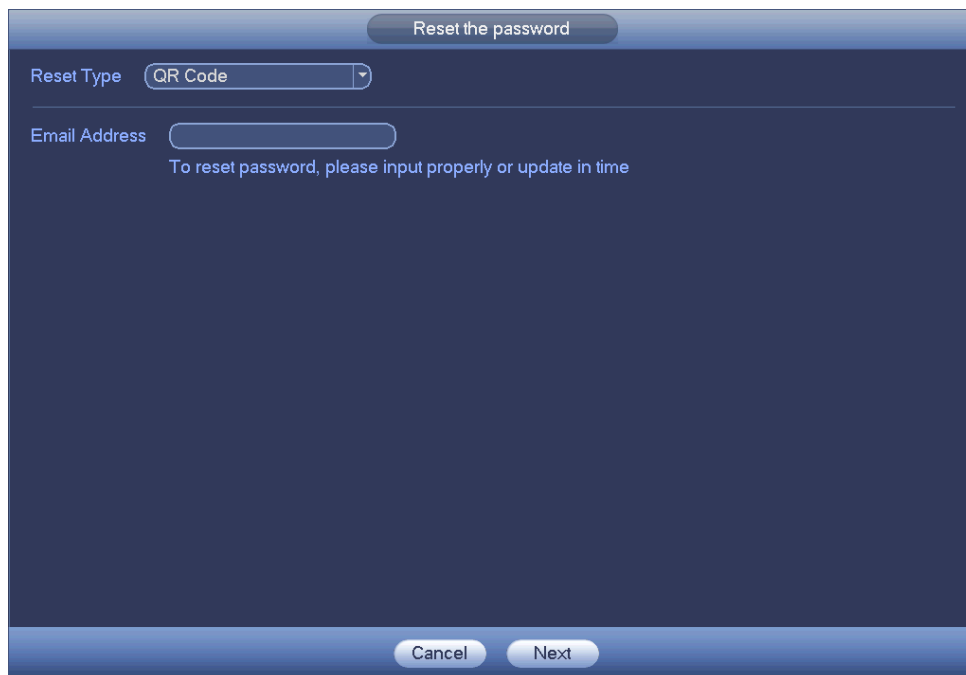

Figure 2-6

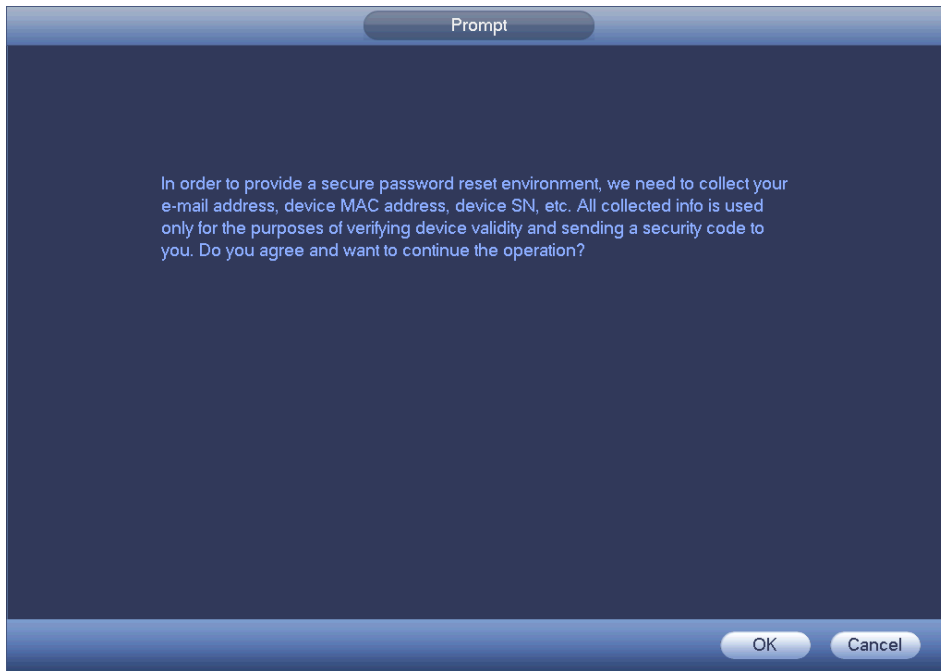

Figure 2-7

Step 3 Input an email address and then click Next button.  
Enter reset password interface. See Figure 2-8.

 **Note**

Click Next, we are going to collect your information for reset password purpose. The collected information includes but not limited to your cellphone number, device MAC address, device SN. Please read the the notice carefully and make sure you agree to our information collection operation.



Figure 2-8

Step 4 Reset login password.

There are two ways to reset the password: Scan QR code and reset by email/security questions (local menu only)

- Email

In Figure 2-8, follow the prompts on the interface to scan the QR code, and then input the security code you get via the assigned email.



### Warning

- ✧ For the same QR code, max scan twice to get two security codes. Refresh the QR code if you want to get security code again.
- ✧ The security code on your email is only valid for 24 hours.

- Security questions

In Figure 2-7., select security question from the drop down list. Device displays security question interface. See Figure 2-9. Please input the correct answers here.



### Note

There is no security question item from the dropdown list if you have not set the security question and corresponding answers when initializing the device.

Reset the password

Reset Type: Security Questions

Question 1: What is your favorite children's book?  
Answer: [Input Field]

Question 2: What was the first name of your first boss?  
Answer: [Input Field]

Question 3: What is the name of your favorite fruit?  
Answer: [Input Field]

Cancel Next

Figure 2-9

Step 5 Click Next button.

Device displays reset password interface. See Figure 2-10.

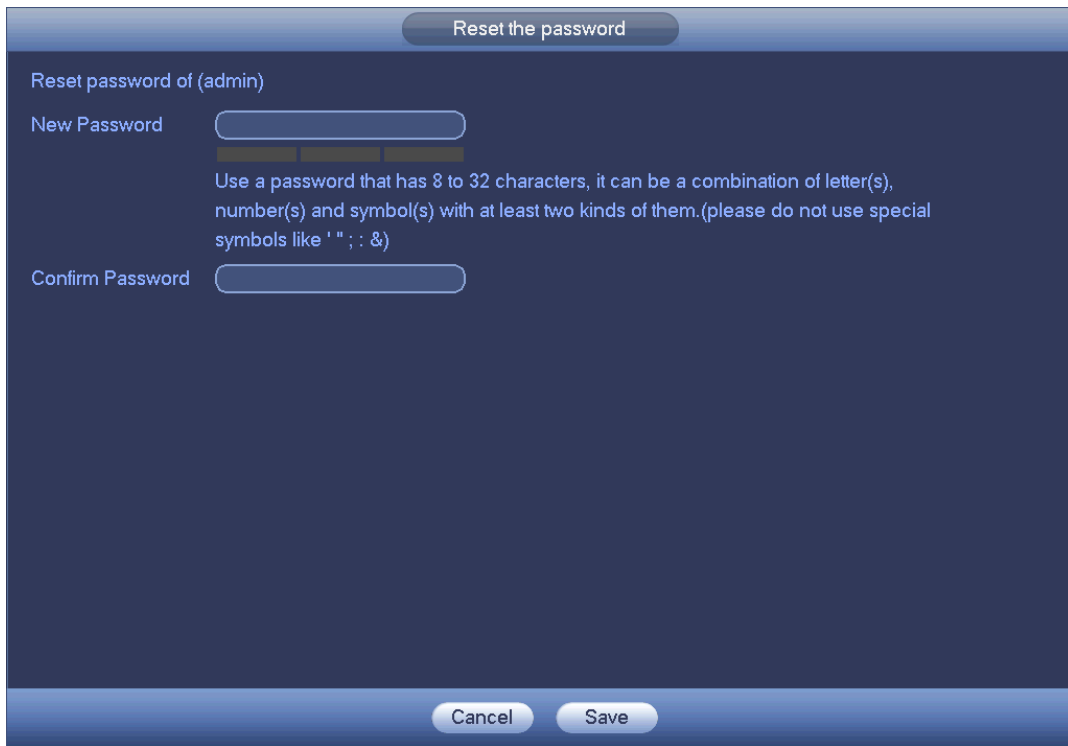

Figure 2-10

Step 6 Input new password and then confirm.



**WARNING**

**STRONG PASSWORD RECOMMENDED-For your device own safety, please create a strong password of your own choosing. The password shall be at least 8-digit containing at least two types of the following categories: letters, numbers and symbols. We also recommend you change your password periodically especially in the high security system.**

Step 7 Click OK button to complete the reset setup.

Device pops up dialogue box asking you to sync the password to the camera connecting by the default protocol. See Figure 2-11. Click OK to change the camera password. See Figure 2-12.



**Note**

The following interface pops up if there is one IP channel (or more than one IP channel). Otherwise, you cannot see the following dialogue box.

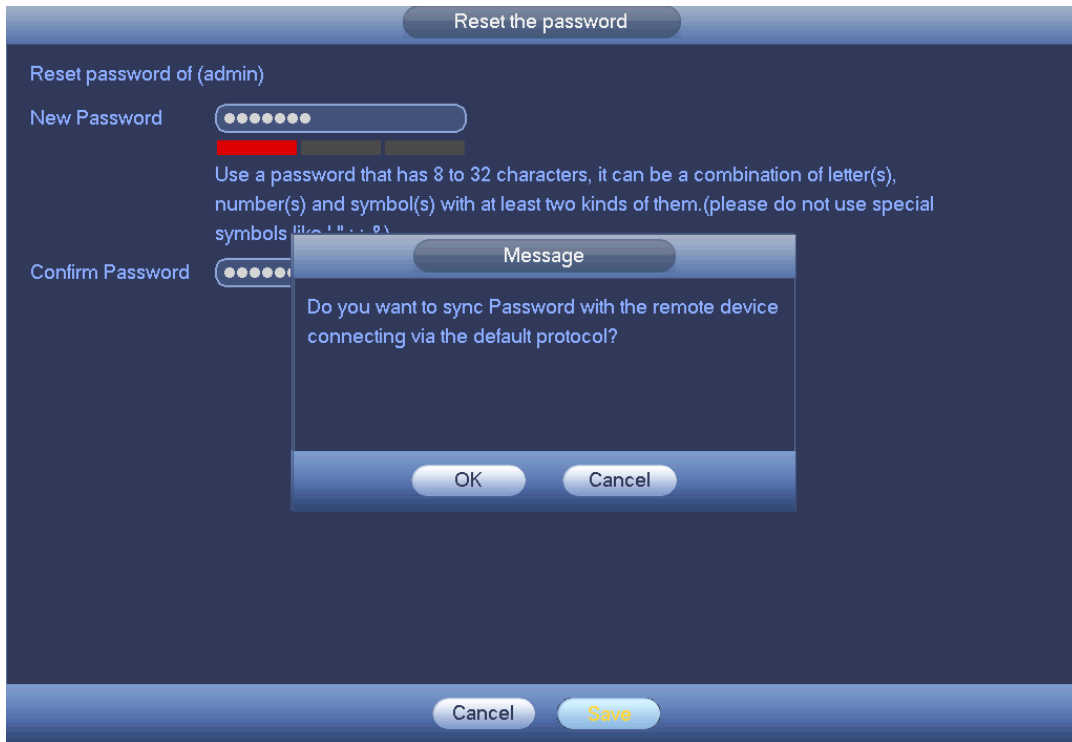

Figure 2-11



Figure 2-12

## 2.4 Quick Settings

The startup wizard and the configuration wizard can guide you to complete the basic settings so that the device can work properly.



- Startup wizard: After initialize the device, system goes to the startup wizard interface. See Figure 2-13. Please refer to the user's manual for detailed startup wizard operation information.
- Configuration wizard: On the preview interface, right click mouse and then click configuration wizard. The setting items are the same as the startup wizard.

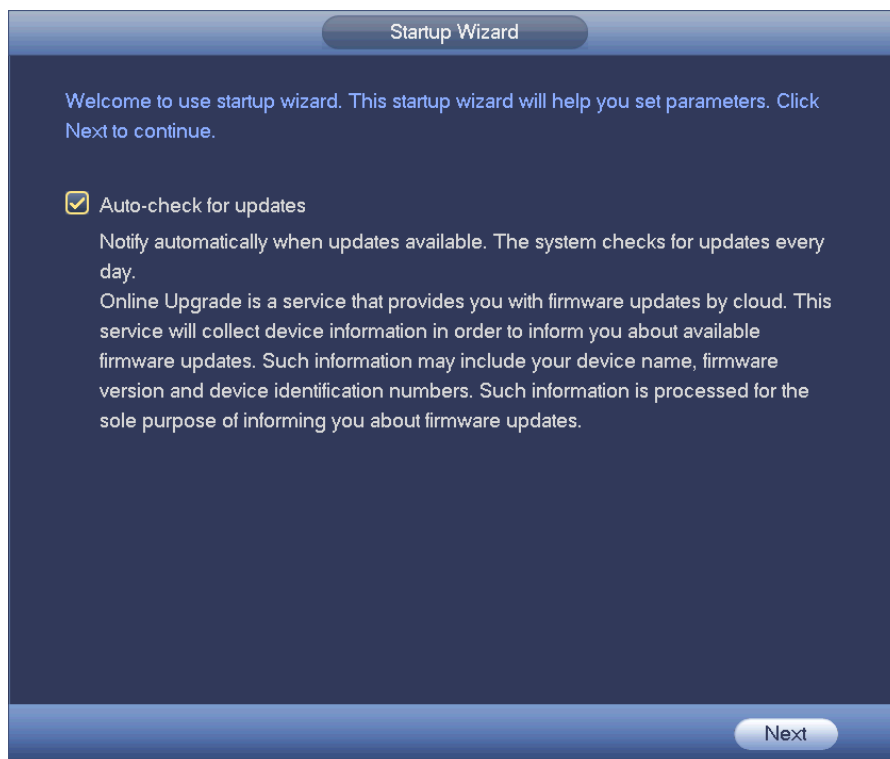

Figure 2-13

 **Note**

- Check the box Startup button here, system goes to startup wizard again when it boots up the next time.
- Cancel the Startup button, system goes to the login interface directly when it boots up the next time.
- From main menu->Setting->System->General->General, you can enable/disable startup wizard.

Step 1 Click Next.

Enter login interface. See Figure 2-14.

- Device ID: Please input a corresponding device name here.
- Device No: Here you can set device number.
- Language: System supports various languages: Chinese (simplified), Chinese (Traditional), English, Italian, Japanese, French, Spanish (All languages listed here are optional. Slight difference maybe found in various series.)
- Video standard: There are two formats: NTSC and PAL.
- Instant playback: It is to set playback time you can view in the preview interface. The value ranges from 5 to 60 minutes.
- Auto logout: Here is for you to set auto logout interval once login user remains inactive for a specified time. Value ranges from 0 to 60 minutes.

- Monitor channels when logout: Here you can set channels you want to view when your account has logged out. Click the button and then cancel the channel name box, you need to login to view the corresponding video. The channel window displays  in preview interface.
- IPC Time Sync: You can input an interval here to synchronize the DVR time and IPC time.
- Navigation bar: Check the box here, system displays the navigation bar on the interface.
- Mouse sensitivity: You can set double click speed via dragging the slide bard. You can Click Default button to restore default setup.



Figure 2-14

## 2.5 Network

Before the operation, please make sure you have properly connected the device to the network.

- If there is no router, please set the corresponding IP address.
- If there is a router, please set corresponding gateway and subnet mask.

From the main menu->Setting->Network, you can go to the following interface.

The single network adapter interface is shown as in Figure 2-15 and the dual network adapters interface is shown as in Figure 2-16.

Here is for you to input network information such as IP address, subnet mask, default gateway and etc.



### Note

- Click Test to check current network settings are OK or not.
- Refer to user's manual for detailed parameter settings information.



Figure 2-15



Figure 2-16

## 2.6 P2P

P2P is a peer to peer technology. There is no need to use dynamic domain, port mapping or install proxy server. You can scan the QR code to download the cellphone app, register an account and then you can register and manage several devices on the cell phone at the same time.

You can add a device via the client on the cellphone or the platform.

- Scan the QR code on the actual interface to download the cell phone app. Register an account and then use.
- Go to the P2P management platform, via the SN from scanning the QR code, you can access the device in the WAN. Please refer to the P2P operation manual.

From main menu->Setting->Network->P2P, you can go to the following interface, the P2P interface is shown as in Figure 2-17.



Before use the P2P function, make sure the DVR has connected to the WAN.



After you enable P2P function and connect the device to the Internet, we are going to collect device information including but not limited to device IP address, device name, device firmware, device SN. The collected information is only to access the device remotely.

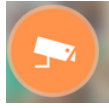

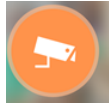

Figure 2-17

Here we use cell phone APP to continue.

Step 1 Use cell phone to scan the QR code and download the APP.

Step 2 After installation, run the APP and Live Preview, enter the main interface. Now you can add device to the APP.



1. Open App; tap  to go to the Live preview.
2. Tap  at the top left corner, you can see the main menu.
3. Tap Device manager button, you can use several modes (P2P/DDNS/IP and etc.) to add the device. Click  to save current setup. Tap Start Live preview to view all-channel video from the connected device. See Figure 2-18.

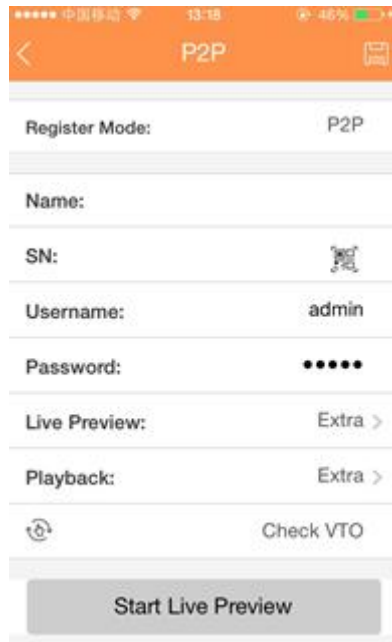

Figure 2-18

## 2.7 Registration

### Note

You can see this interface after you set IP channel in chapter 2.13. System supports ONVIF standard protocol.

In the main menu, from Setting->Camera ->Registration, you can go to an interface shown as in Figure 2-19. Here you can add/delete remote device and view its corresponding information.



Figure 2-19

- Uninitialized: Click Uninitialized, device display uninitialized remote device. Select a device from the list and then click Initialize, you can set remote device initial user name and password. Please refer to the corresponding user's manual for detailed information.
- Show filter: Select from the dropdown list to display the corresponding devices.
  - ◇ None: There is a filter. Device displays all remote devices.
  - ◇ IPC: Device displays network camera.
  - ◇ DVR: Device display storage device such as DVR, NVR and etc.
- IP search: Click it to search IP address. It includes device IP address, port, device name, manufacturer, type. Use your mouse to click the item name, you can refresh display order. Click IP address, system displays IP address from small to large. Click IP address again, you can see icon, system displays IP address from large to small. You can click other items to view information conveniently.
- Add: Click it to connect to the selected device and add it to the Added device list. Support Batch add.

**You can see the corresponding dialogue box if all digital-channel has connected to the front-end.**

**System cannot add new device if the device you want to add has the same IP and TCP port as the device in the list.**

- Edit: Click button or double click a device in the list, you can change channel setup.
- Delete: Please select one device in the Added device list and then click to remove.
- Status: means connection is OK and means connection failed.

- Delete: Select a device on the Added device list, click Delete button, system disconnect device first and then remove its name from the list.
- Manual add: Click it to add the IPC manually. The port number is 37777.
- Organize videos: Click organize videos button, the interface is shown as in Figure 2-22. Select a channel and then click Move up or Move down, you can set remote device channel sequence.
- Change IP:
  - ✧ Click , you can change the information such as IP address, subnet mask, default gateway of the checked device. See Figure 2-20.

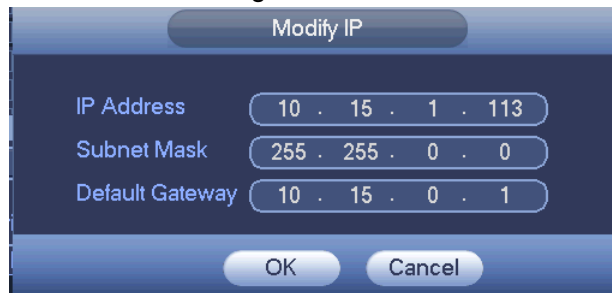

Figure 2-20

- ✧ You can check several devices at the same time and then click the edit button . See Figure 2-21. Please check Batch modify button and then input start IP, end IP and default gateway.



Figure 2-21



Figure 2-22

## 2.8 Record Control

### Note:

You need to have proper rights to implement the following operations. Please make sure the HDD has been properly installed.

There are three ways for you to go to manual record menu.

- Right click mouse and then select Manual->Record.
- In the main menu, from Storage->Record.
- In live viewing mode, click record button in the front panel or record button in the remote control.

Manual record menu is shown as in Figure 2-23.

System supports main stream and sub stream. There are three statuses:

schedule/manual/stop. Please highlight icon “○” to select corresponding channel.

- Manual: The highest priority. After manual setup, all selected channels will begin ordinary recording.
- Schedule: Channel records as you have set in recording setup (Main Menu->Setting->System->>Schedule)
- Stop: Current channel stops recording.
- All: Check All button after the corresponding status to enable/disable all-channel schedule/manual record or enable/disable all channels to stop record.





Figure 2-23

## 2.9 Schedule

### Note:

You need to have proper rights to implement the following operations. Please make sure the HDDs have been properly installed.

After the system booted up, it is in default 24-hour regular mode. You can set record type and time in schedule interface.

In the main menu, from Setting->Storage->Schedule, you can go to schedule menu. See Figure 2-24.

- Pre-record: System can pre-record the video before the event occurs into the file. The value ranges from 1 to 30 seconds depending on the bit stream.
- Redundancy: System supports redundancy backup function. You can highlight Redundancy button to activate this function. Please note, before enable this function, please set at least one HDD as redundant. (Main menu->Setting->Storage->HDD Manager). Please note this function is null if there is only one HDD.
- ANR: It is to save video to the SD card of the network camera in case the network connection fails. After the network connection resumed, the system can get the video from the SD card and there is no risk of record loss. Please make sure there is SD card on the camera.

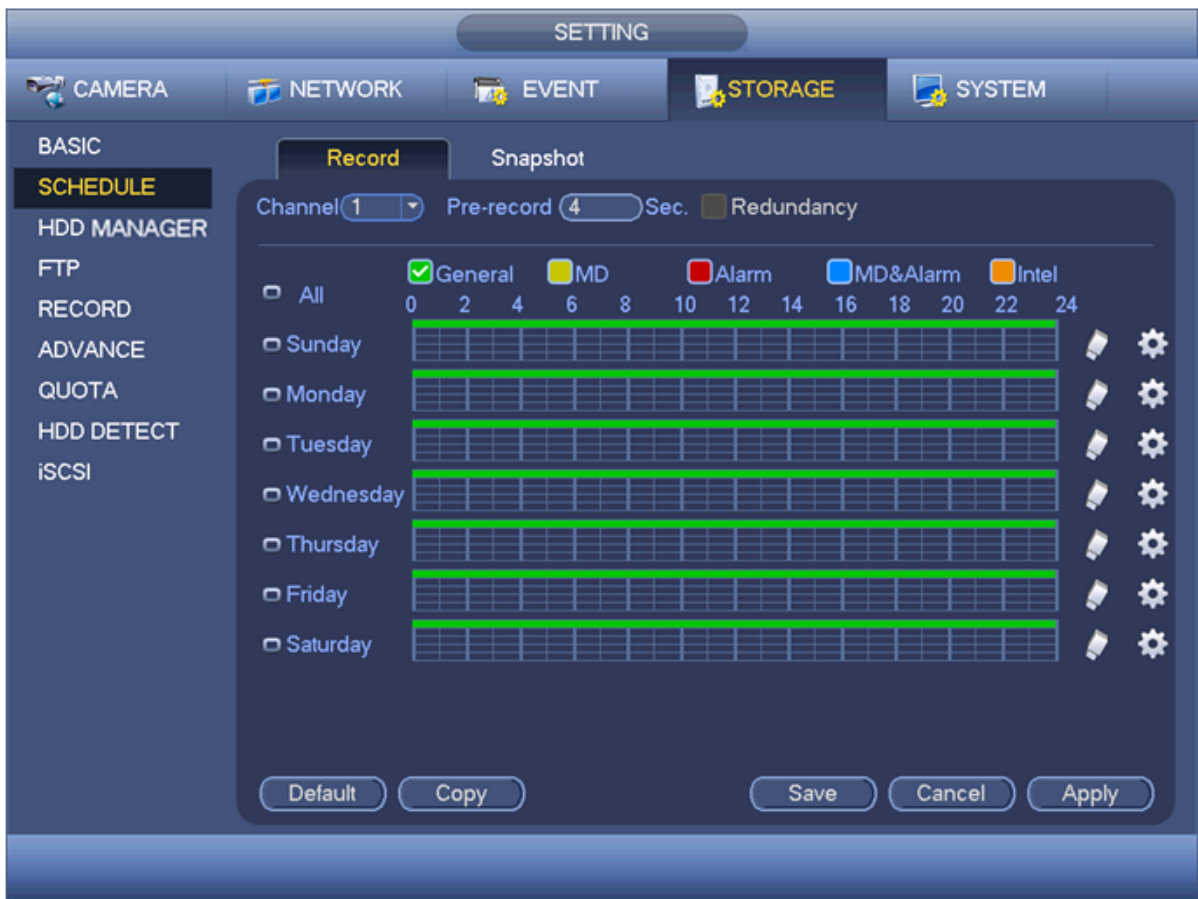

Figure 2-24

## 2.10 Preview

After you logged in, the system is in live viewing mode by default. You can see system date, time and channel name. See Figure 2-25. If you want to change system date and time, you can refer to general settings (Main Menu->Setting->System->General). If you want to modify the channel name, please refer to the channel name settings (Main Menu->Setting->Camera->CAM Name)

At the right corner of the each window, you can see there is a window serial number. Once the channel sequence is random or you have changed the channel name, you can use this window number to confirm current channel name so that you can search the record or playback.

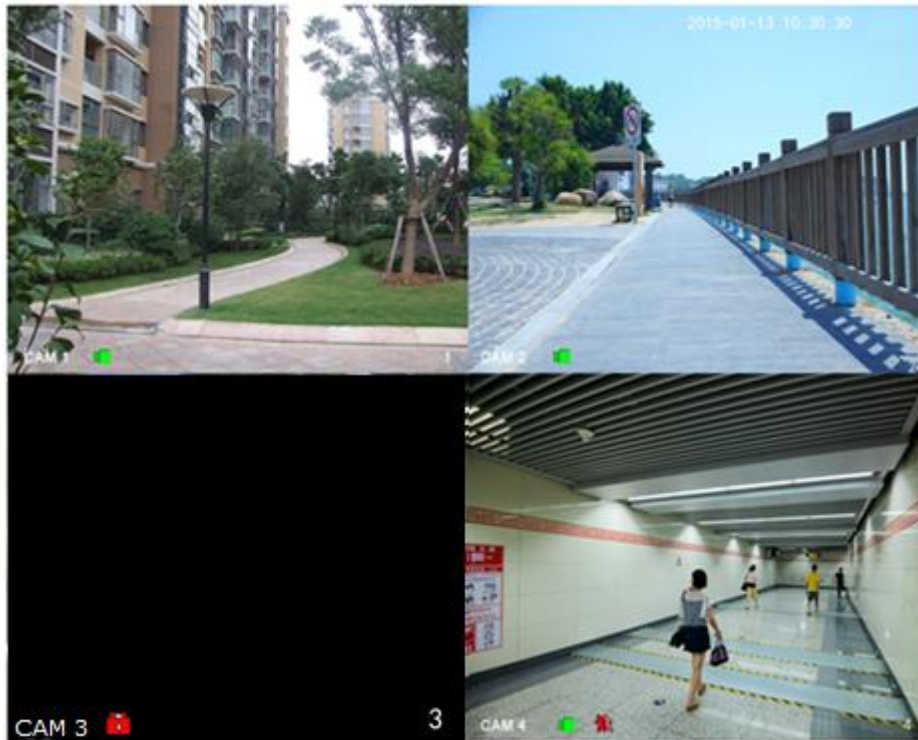





Figure 2-25

1		When current channel is recording, system displays this icon.	3		When video loss alarm occurs, system displays this icon.
2		When motion detection alarm occurs, system displays this icon.	4		When current channel is in monitor lock status, system displays this icon.

**Tips**

- Preview drag: If you want to change position of channel 1 and channel 4 when you are previewing, you can left click mouse in the channel 1 and then drag to channel 4, release mouse you can switch channel 1 and channel 4 positions.

## 2.11 Playback

### 2.11.1 Instant Playback

Move your mouse to the top center of the video of current channel, you can see system pop up the preview control interface. See Figure 2-26 (The image at the top left). If your mouse stays in this area for more than 6 seconds and has no operation, the control bar automatically hides.

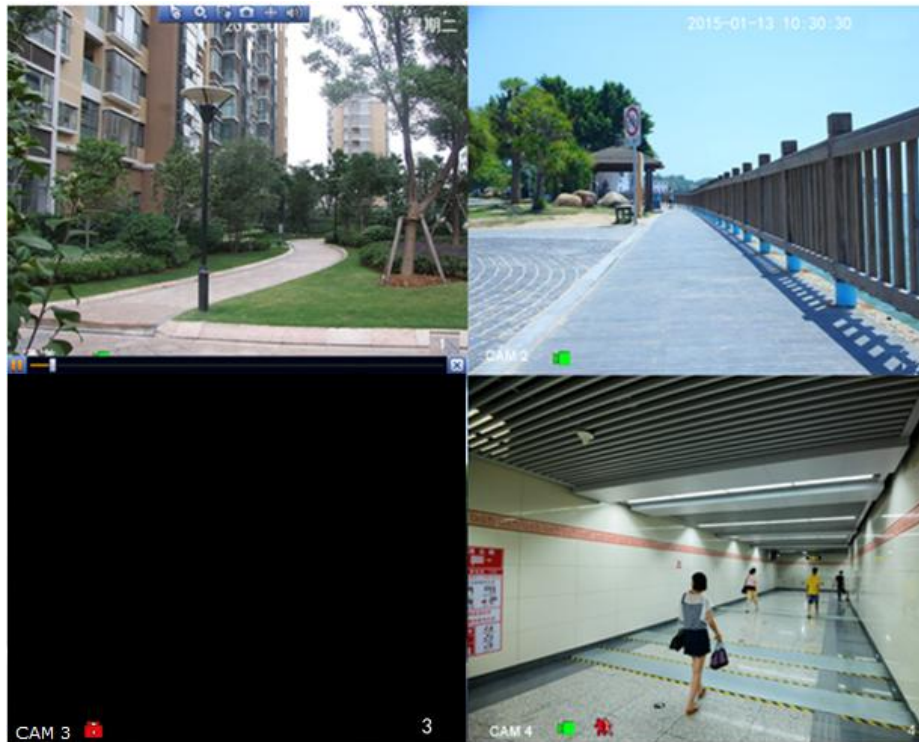



Figure 2-26

Click , you can go to the realtime playback interface. It is to playback the previous 5-60 minutes record of current channel.

Please go to the Main Menu->Setting->System->General to set real-time playback time. System may pop up a dialogue box if there is no such record in current channel.

### 2.11.2 Historical Search & Playback

Click search button in the main menu, or right click mouse and then select Search button when you are previewing, search interface is shown as below. See Figure 2-27.

Usually there are four file types:

- R: Regular recording file.
- A: External alarm recording file.
- M: Motion detection recording file.
- Intel: Intelligent recoding file.

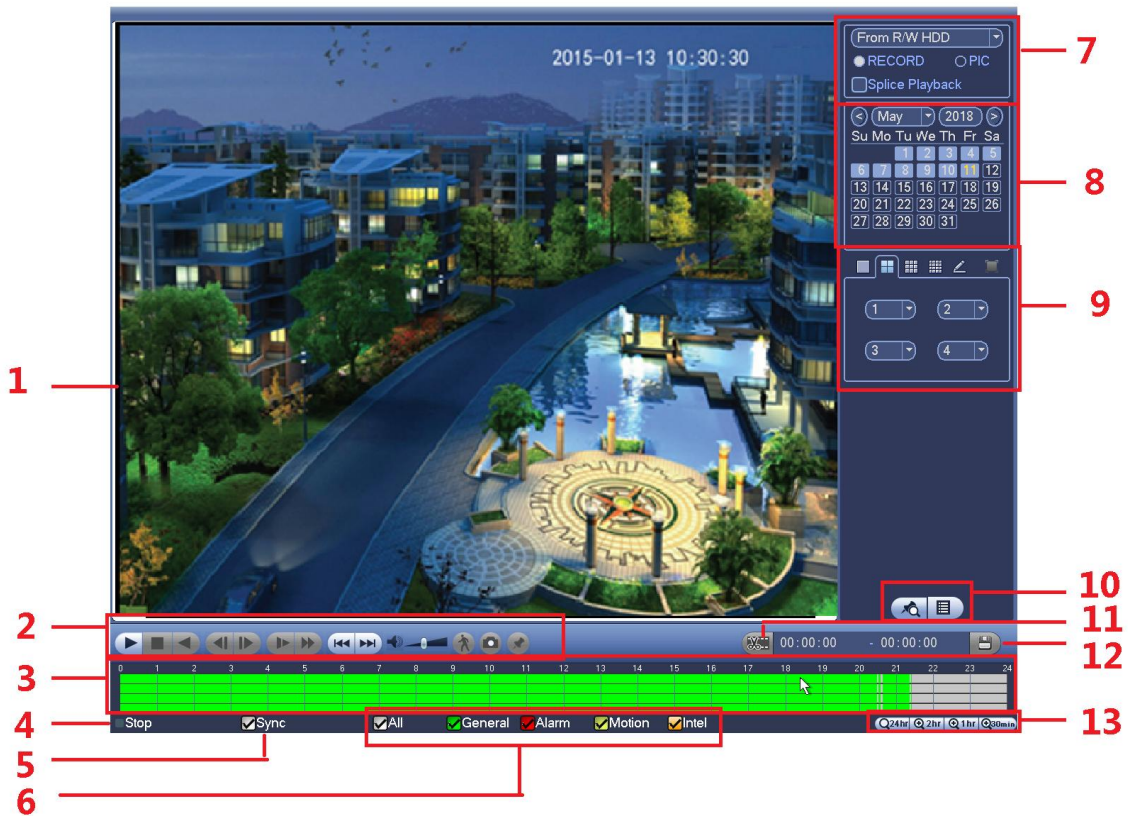

Figure 2-27

Please refer to the following sheet for more information.

SN	Name	SN	Name
1	Display pane	2	Playback control pane
3	Time bar	4	Playback state
5	Sync playback	6	Record type
7	Search type selection pane	8	Calendar
9	Playback mode and channel selection pane	10	List selection pane
11	Video clip	12	Backup
13	Time bar unit		

## 2.12 PTZ

### 2.12.1 PTZ Setup

From main menu->Setting->System->PTZ, you can see the following interface. See Figure 2-28.

- PTZ type: There are two options: local/remote. Local refers to the analog channel and the remote refers to the IP channel. Please select remote if you are connecting to the network PTZ.
- Control mode: There are two options: Serial/HDCVI. Serial is for RS485 mode. In serial mode, the control signal is transmitted via the RS485 to control the PTZ. The HDCVI is for coaxial mode, the control signal is transmitted via the coaxial cable to control the PTZ.



After completed all the setups please click save button, system goes back to the previous menu.



Figure 2-28

### 2.12.2 PTZ Operation

In one window display mode, right click mouse (click “Fn” Button in the front panel or click “Fn” key in the remote control) and then select PTZ, the interface is shown as in Figure 2-29.

Click icon  and  to adjust zoom, focus and iris.

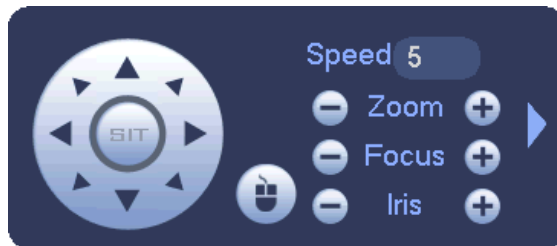













Figure 2-29

Please refer to the following sheet for detailed information.

Name	Button	Function	Shortcut key on the front panel
Zoom		Near	Slow play 
		Far	Fast forward 
Focus		Near	Previous 
		Far	Next 
Iris		Close	Backward 
		Open	Pause/Play 













In Figure 2-29, click  to open the menu, you can set preset, tour, pattern, scan and etc. See Figure 2-30.



Figure 2-30

Please refer to the following sheet for detailed information.

Icon	Function	Icon	Function
	Preset		Flip
	Tour		Reset
	Pattern		Aux
	Scan		Aux on-off button
	Rotate		Go to menu

### 2.12.3 Call OSD Menu

 **Note**

- Coaxial data is not for all cameras. Refer to the actual interface for detailed information.
- Refer to the user's manual for detailed information.

For HDCVI camera, you can use the PTZ to call the camera OSD menu and set parameters.

Step 1 In Figure 2-30, click  to enter Menu operation interface. See Figure 2-31.



Figure 2-31

Step 2 Click the Enter button, you can see the OSD menu of the HDCVI camera. See Figure 2-32.

Step 3 Use direction buttons on Menu operation interface (Figure 2-31) to select the parameters and click the “Enter” to confirm.

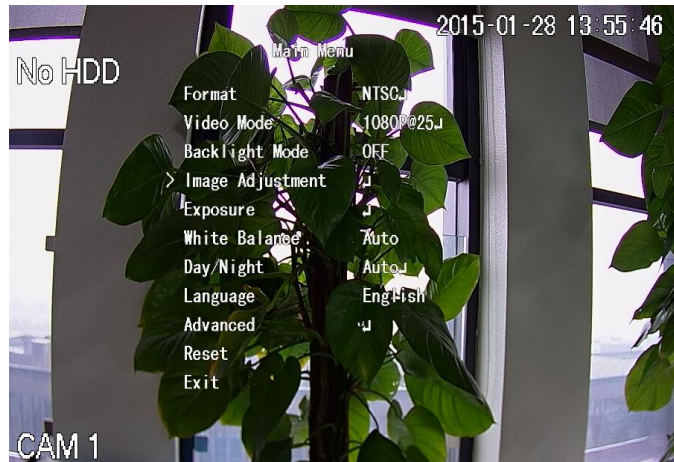

Figure 2-32

## 2.13 Channel Type

### Note

Please note this function is for some series product only. Slight different maybe found on the user interface.

From main menu->Setting->Camera->Channel type, the interface is shown as below. See Figure 2-33. It is to set channel type.

- Analog channel (CVBS signal or HDCVI signal and etc.): Please select the corresponding cable and then save. There is no need to reboot.
- Device supports IP channel. The network camera connection shall begin with the last channel. Please note DVR needs to restart to activate new setup.

### Note

Add IP channel function refers to the extra IP channel amount except current channel total amount (analog+IP). Different series products may support different extra IP channel amount. For 16-channel series product (16 analog channel+48 IP channel), check the channel 17 to channel 64, it is to change these channels to IP channels. See Figure 2-33.



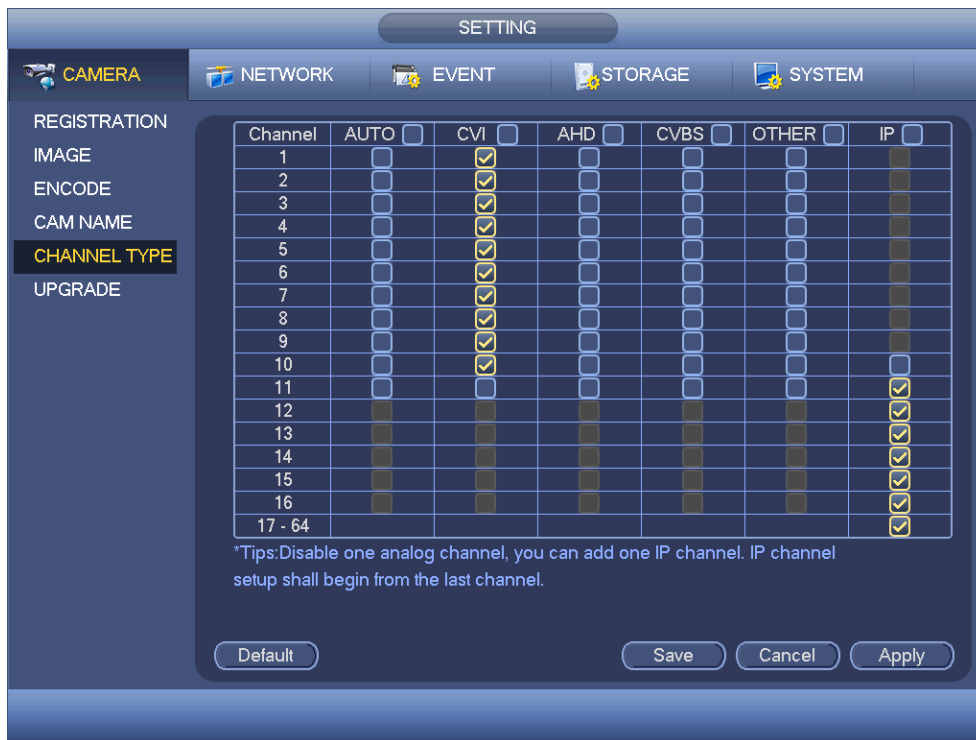

Figure 2-33

## 2.14 Shut Down

### Note

- When you see corresponding dialogue box “System is shutting down...” Do not click power on-off button directly.
- Do not unplug the power cable or click power on-off button to shutdown device directly when device is running (especially when it is recording.)

There are three ways for you to log out.

- Main menu (**RECOMMENDED**): From Main Menu->Operation->Shutdown, click shutdown button, you can see device shuts down. See Figure 2-34.



Figure 2-34

- From power on-off button on the front panel or remote control. Press the power on-off button on the DVR front panel or remote control for more than 3 seconds to shut down the device.
- From power on-off button on the rear panel.

### 3 Web Operation

Slightly difference may be found in the interface due to different series.

#### 3.1 Network Connection

Before web client operation, please check the following items:

- Network connection is right
- DVR and PC network setup is right. Please refer to network setup(main menu->Setting->Network)
- Use order ping **\*\*\*.\*\*\*.\*\*\*.\*\*\***(\* DVR IP address) to check connection is OK or not. Usually the return TTL value should be less than 255.
- Current series product supports various browsers such as Safari, fire fox browser, Google browser. Device supports multiple-channel monitor, PTZ control, DVR parameter setup on the Apple PC.

#### 3.2 Login

Step 1 Open IE and input DVR address in the address column. For example, if your DVR IP is 10.10.3.16, then please input http:// 10.10.3.16 in IE address column.

Step 2 System pops up warning information to ask you whether install control or not. Please click Install button, system can auto run the installation. Or follow the prompts to save the installation package and install. After installation, the interface is shown as below. See Figure 3-1.



Figure 3-1

Step 3 Please input user name and password.

### Note

- Device factory default user name is **admin**. The password is that you set during initialization process. For your device safety, please change the admin password regularly and keep it well.
- Check the Plain text to view the input password.
- In case you forgot password, click Forgot password to reset. Refer to the user's manual for detailed information.
- There are two login model: LAN/WAN. For the difference of these two modes, please refer to the user's manual.

Step 4 Click Login to enter the preview interface.

## 3.3 Main Window

### 3.3.1 LAN Login

For the LAN mode, after you logged in, you can see the main window. See Figure 3-2. Click the channel name on the left side; you can view the real-time video.



Figure 3-2

### 3.3.2 WAN Login

In WAN mode, after you logged in, the interface is shown as below. See Figure 3-3.

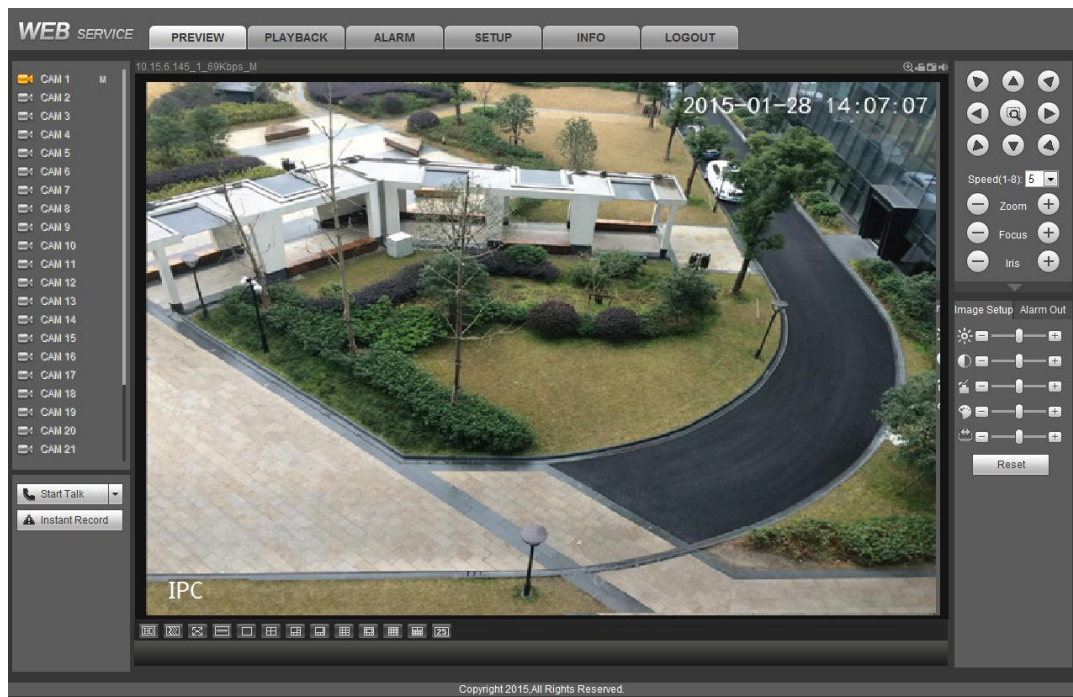

Figure 3-3

 **Note**

For detailed operation introduction, please refer to *User's Manual*.