



## **2 MP Network Mini PTZ Camera**

**22204TNI**

### **Quick Start Guide**

Version 001.001

Dahua Technology USA Inc.

## Table of Contents

1	Welcome.....	1
1.1	Important Safeguards and Warnings.....	1
	Electrical safety .....	1
	Environmental Precautions .....	2
	Operation and Daily Maintenance .....	3
	Lifting Appliance Requirement .....	3
	Warnings.....	3
1.2	FCC Information.....	4
	FCC compliance: .....	4
1.3	Legal Notices .....	4
	Copyright.....	4
	Trademarks.....	4
1.4	Disclaimer .....	5
2	Unpacking.....	6
2.1	Parts List .....	6
3	Installation and Configuration .....	7
3.1	Framework and Dimensions .....	7
4	Device Installation .....	8
4.1	Preparing the Camera.....	8
4.2	Insert a Micro SD Card.....	9
4.3	Mounting the Camera to a Ceiling.....	9
5	Network Configuration .....	11
5.1	Network Protocols.....	11
5.2	Modifying the IP Address .....	12
5.3	Using the ConfigTool.....	12
5.4	Accessing the Web Interface .....	13
5.5	Configuring Alarms.....	<b>Error! Bookmark not defined.</b>
5.6	Configuring Local SD Card Recording .....	14

# 1 Welcome

This manual offers reference material and general information about the basic operation, maintenance, and troubleshooting of a Dahua Network PTZ Camera. Read, follow, and retain the following safety instructions. Heed all warning on the unit and in the operating instructions before operating the unit. Keep this guide for future reference.

## 1.1 Important Safeguards and Warnings

### Electrical safety

- Install the unit in accordance with the manufacturer's instructions and in accordance with applicable local codes.
- All installation and operation must conform to your local electrical safety codes.
- Do not overload outlets and extension cords, which may cause fire or electrical shock.
- Do not place the camera near or in a place where the camera may contact overhead power lines, power circuits, or electrical lights.
- Ensure power conforms to SELV (Safety Extra Low Voltage) and that the limited power source is rated AC 24V as specified in IEC60950-1.
- All input/output ports are SELV circuits. Ensure that SELV circuits are connected only to other SELV circuits.
- Ground the unit using the ground connection of the power supply to protect the unit from damage, especially in damp environments.
- Protect the plug and power cord from foot traffic, being pinched, and its exit from the unit.
- Units with or without an ON/OFF switch have power supplied to the unit whenever the power cord is inserted into the power source; however, the unit is operational only when the ON/OFF switch is in the ON position. The power cord is the main power disconnect device for switching off the voltage for all units.
- Operate the unit only from the type of power source indicated on the label. Before proceeding, disconnect the power from the cable to be installed into the unit.
  - For external power supplied units, use only the recommended or approved power supplies.
  - Limited power sources must comply with EN 60950. Substitutions may damage the unit or cause fire or shock.
  - For 24 VAC units, voltage applied to the unit's input power should not exceed  $\pm 25\%$ . User-supplied wiring must comply with local codes (Class 2 power levels). Do not ground the supply at the terminals or at the unit's power supply terminal.
  - Contact the local dealer or the power company to verify the correct power supply.
- Do not supply power via the Ethernet connection (PoE) when power is already supplied via the power connector.
- Do not attempt to service the unit. Opening or removing covers may expose you to dangerous voltage or other hazards. Refer all servicing to qualified personnel.

- If the unit is damaged and requires service, unplug the unit from the main AC power supply and from the PoE supply and refer to qualified service personnel. Damage may include, but is not limited to:
  - The power supply cord or plug is damaged.
  - Liquid has spilled in or on the unit.
  - An object has fallen on the unit.
  - The unit has been dropped and the housing is damaged.
  - The unit displays a marked change in performance.
  - The unit does not operate in the expected manner when the user correctly follows the proper operating procedures.
- Ensure a service technician uses replacement parts specified by the manufacturer, or that have the same characteristics as the original parts. Unauthorized parts may cause fire, electrical shock, or other hazards. Dahua is not liable for any damage or harm caused by unauthorized modifications or repairs.
- Perform safety checks after completion of service or repairs to the unit.
- Use attachments and accessories only specified by the manufacturer. Any change or modification of the equipment, not expressly approved by Dahua, could void the warranty.
- Incorporate a readily accessible disconnect device in the building installation wiring for quick power disconnect to the camera.
- Dahua assumes no liability or responsibility for any fire or electrical shock caused by improper handling or installation.

### **Environmental Precautions**

- Do not aim the unit at a strong light source or into direct sunlight to focus. A strong light source may cause overexposure and may affect the longevity of the CCD or the CMOS sensor.
- Transport, use, and store the unit within the specified temperature and humidity range.
- Do not place the unit in a wet, dusty, extremely hot or an extremely cold environment; and avoid environments with strong electromagnetic radiation or unstable lighting.
- Never push objects of any kind into this unit through openings as they may touch dangerous voltage points or cause a short circuit that may result in fire or electrical shock. Take care to not spill any liquid on the unit.
- Do not use units intended for indoor applications near water, in damp or wet environments, or in any area classified as a wet location. Do not expose an indoor unit to rain or moisture to reduce the risk of fire or electric shock.
- Do not block or cover any openings in the unit enclosure. These openings are provided for ventilation to prevent overheating and to ensure reliable operation. Ensure the unit is placed in an area with adequate ventilation.
- Do not place the unit near a heat source such as heaters, stoves, radiators or other equipment that produces heat.
- Pack the unit with standard factory packaging or material of the same quality when transporting the unit.
- Take care to avoid heavy stress, violent vibration, or water spills to the camera unit during transportation, storage, and installation.

## Operation and Daily Maintenance

- Do not touch the heat dissipation component of the unit. This part of the unit is hot and may cause a burn.
- Do not open or dismantle the device; there are no components that a user can fix or replace. Opening the unit may cause water leakage or expose components to direct light. Contact the manufacturer or a qualified service representative to service the camera or to replace a component, including the desiccant.
- Dahua recommends the use of a thunder-proof device in concert with the unit.
- Do not touch the CCD or the CMOS optic sensor. Use a blower to clean dust or dirt on the lens surface. Use a dry cloth dampened with alcohol and gently wipe away any dust on the lens.
- Use a dry soft cloth to clean the unit's housing. If the unit is particularly dusty, use water to dilute a mild detergent, apply the diluted detergent to a soft cloth, then gently clean the device. Finally, use a dry cloth to wipe the unit dry. Do not use a volatile solvent like alcohol, benzene, or thinner; or use a strong detergent with abrasives, which may damage the surface coating or reduce the working performance of the unit.
- Do not touch or wipe a dome cover during installation, this cover is an optical device. Refer to the following methods clean the dome cover:
  - Stained with dirt: Use an oil-free soft brush or blower to gently remove the dirt.
  - Stained with grease or fingerprints: Use a soft cloth to wipe gently the water droplet or the oil from the dome cover. Then, use an oil-free cotton cloth or paper soaked with alcohol or detergent to clean the lens from the center of the dome to outside. Change the cloth several times to ensure the dome cover is clean.

## Lifting Appliance Requirement

- Select the proper PTZ dome installation mode and use the proper lifting device to safely lift the camera at the installation site.
- Ensure that the lifting device has the proper capacity to reach the installation height.
- Use the lifting device in accordance with its operating instructions and abide by the device's safety precautions.

## Warnings

- Change the default password after the initial login to protect the integrity of the network.
- Use the standard accessories provided by the manufacturer and ensure the unit is installed and commissioned by qualified professionals.
- Protect the lens area from laser radiation when using a laser device to aid in installation and leveling of the unit.
- Do not supply power via the Ethernet connection (PoE) when power is already supplied via the power connector.

## 1.2 FCC Information

This device complies with part 15 of the FCC Rules. Operation is subject to the following two conditions:

- This device may not cause harmful interference;
- This device must accept any interference received, including interference that may cause undesired operation.

### **FCC compliance:**

This equipment has been tested and found to comply with the limits for a digital device, pursuant to part 15 of the FCC Rules. These limits are designed to provide reasonable protection against harmful interference. This equipment generates uses and can radiate radio frequency energy and, if not installed and used in accordance with the instruction manual, may cause harmful interference to radio communication. However, there is no guarantee that interference will not occur in a particular installation. If this equipment does cause harmful interference to radio or television reception, which can be determined by turning the equipment off and on, the user is encouraged to try to correct the interference by one or more of the following measures:

- Reorient or relocate the receiving antenna.
- Increase the separation between the equipment and receiver.
- Connect the equipment into an outlet on a circuit different from that to which the receiver is connected.
- Consult the dealer or an experienced radio/TV technician for help.

## 1.3 Legal Notices

### **Copyright**

This user guide is ©2018, Dahua Technology Company, LTD.

This user guide is the intellectual property of Dahua Technology Company, LTD and is protected by copyright. All rights reserved.

### **Trademarks**

All hardware and software product names used in this document are likely to be registered trademarks and must be treated accordingly.

## 1.4 Disclaimer

- This user guide has been compiled with great care and the information it contains has been thoroughly reviewed and verified. The text was complete and correct at the time of printing. This guide may be periodically updated to reflect changes to the product or to correct previous information and the content of this guide can change without notice. If you encounter an error or have any questions regarding the contents of this guide, contact customer service for the latest documentation and supplementary information. Dahua accepts no liability for damage resulting directly or indirectly from faults, incompleteness, or discrepancies between this guide and the product described. Dahua is not liable for any loss caused by installation, operation, or maintenance inconsistent with the information in this guide.
- Video loss is inherent to all digital surveillance and recording devices; therefore Dahua cannot be held liable for any damage that results from missing video information. To minimize the occurrence of lost digital information, Dahua recommends multiple, redundant recording systems, and adoption of backup procedure for all data.
- Contact the supplier or customer service if you encounter any issue while using this unit.

## 2 Unpacking

This equipment should be unpacked and handled with care. If an item appears to have sustained damage during shipping, notify the shipper immediately.

Verify that all the parts listed below are included. If an item is missing, contact customer support or your local representative.

The original packing carton is the safest container to transport the unit, in the event the unit must be returned for service. Retain the carton and all shipping material for future use.

Please refer to the enclosed CD for more details, to view the detailed User's Manual, and for configuration software.

### 2.1 Parts List

Package Item	Quantity
Network Camera	1
Expansion Bolts	3
Screws	3
Washers	3
Quick Start Guide	1
Documentation CD	1



### 3 Installation and Configuration

#### 3.1 Framework and Dimensions

The following figures show the dimensions of the device in mm (in.). These images are intended as a reference only.

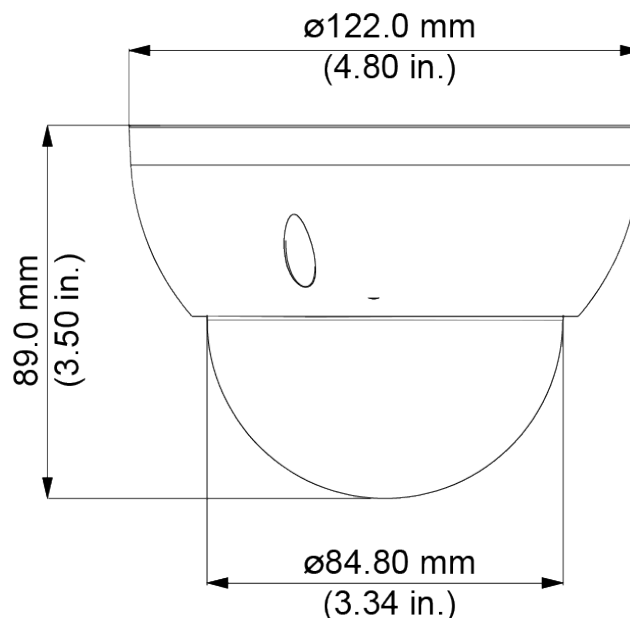

Figure 3-1: Dimensions

#### 3.2 Locally Storing Data

Certain cameras include a SDHC card slot for onboard storage that support a 128 GB Micro SD card. Dahua recommends using a SanDisk Extreme Micro SD card (or an equivalent substitute) as these cards have been fully tested without issue and the SanDisk Extreme line is better suited for constant recording. Lower-grade SD cards meant for multimedia applications will, at times, have questionable quality and reliability.

Recording to the SD card is first in first out (FIFO). The camera deletes the oldest (first) entry as new storage requirements arise. The camera does not signal nor make an indication when data is deleted. Storage time is dependent on a variety of factors such as SD card size, image resolution and video frames per second.

SD Recording supports video only. Audio is not supported.

## 4 Device Installation

This section details installing the camera to a solid wall or to a ceiling, in an outdoor or an indoor environment. Note that the wall or ceiling must be capable of supporting a minimum of eight (8) times the weight of the camera and a bracket (if used).

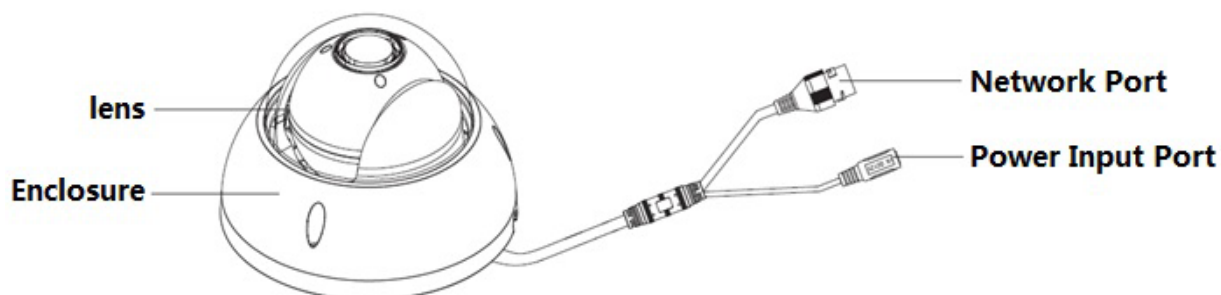

DO NOT connect the camera to the power supply during installation.

**Warning:** DO NOT connect the camera to the power supply during installation.

**Warning:** For units intended to be installed outdoors: All wiring connecting to the unit must be routed separately inside a different permanently earthed metal conduits (not supplied).

**Warning:** Install external interconnecting cables in accordance to NEC, ANSI/NFPA70 (for US application) and Canadian Electrical Code, Part I, CSA C22.1 (for CAN application) and in accordance to local country codes for all other countries. Branch circuit protection incorporating a 20 A, 2-pole Listed Circuit Breaker or Branch Rated Fuses are required as part of the building installation. A readily accessible 2-pole disconnect device with a contact separation of at least 3 mm must be incorporated.

**Note:** Dahua recommends attaching a “drip loop” (flex or hard conduit) during installation to ensure condensation does not form in the mount or the conduit.

**Note:** 24 VAC Class 2 power supply only.

### 4.1 Preparing the Camera

1. Remove the camera, the mount accessories and any hardware packages from the boxes.
2. Remove the camera from the plastic wrapping and place the camera dome-end up in the foam packaging.
3. Loosen the three torx screws from the enclosure and remove the enclosure from the base.

## 4.2 Insert a Micro SD Card

1. Open the cover for the SD Card slot.
2. Insert the Micro SD Card into the Micro SD Card slot.
3. Replace the cover.

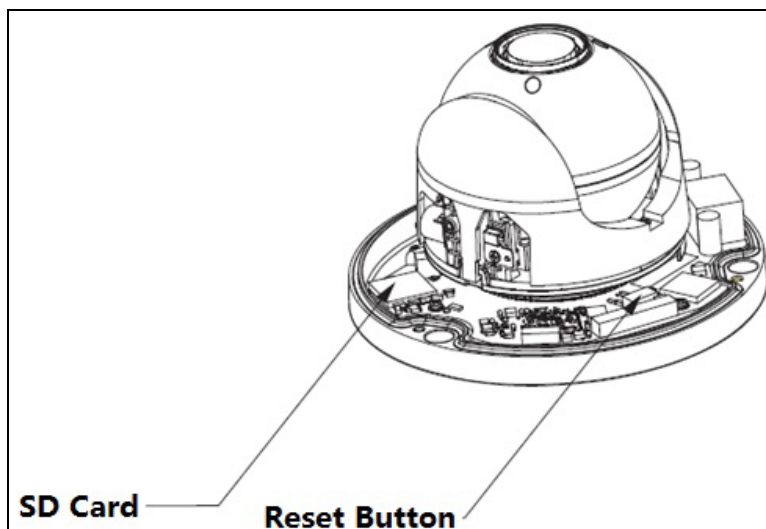
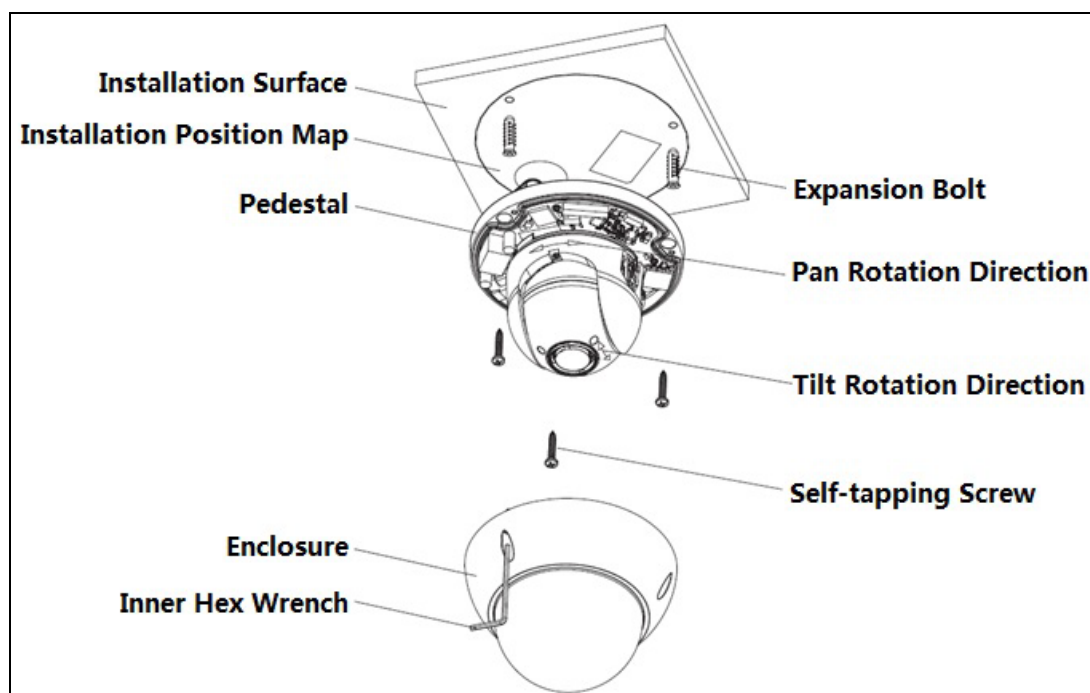
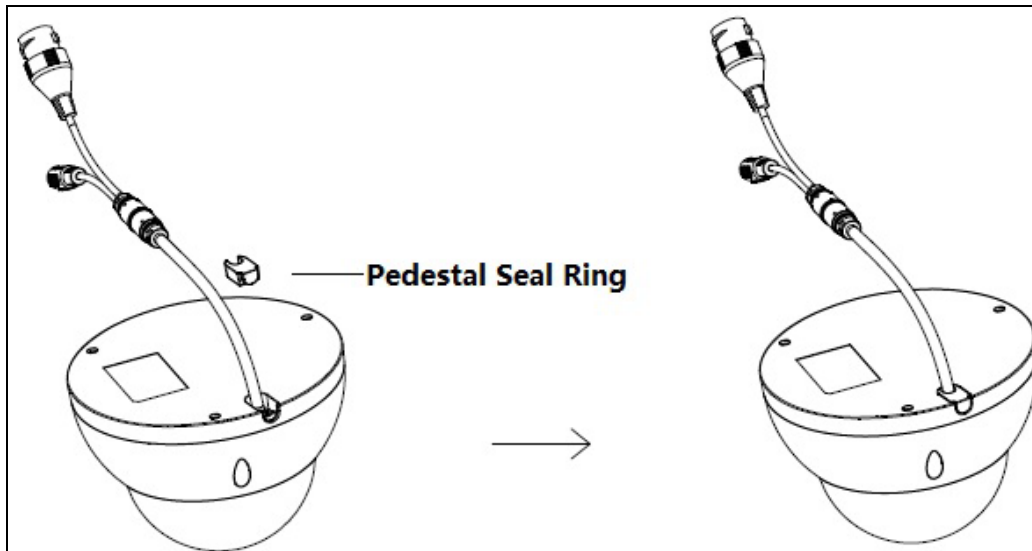

Figure 4-1

## 4.3 Mounting the Camera to a Ceiling



1. Place the mounting template against the ceiling and mark the location of the center hole and the three perimeter mounting holes.
2. Determine the route of the outgoing cables, either a center route through the ceiling medium or a side exit to a grounded conduit. If the cables are routed through the ceiling, then place the pedestal seal ring into the slot on the side of the camera base.



3. Pre-drill the three perimeter holes as marked on the wall for the expansion bolts, using a drill bit that is no wider than the expansion bolt.
4. Drill a 50-mm (approximately 2 in.) center hole to route the cables, if necessary.
5. Insert an expansion bolt into each pre-drilled perimeter hole, if necessary.
6. Pull the composite cable from the dome through the ceiling.
7. Align the screw holes in the pedestal with the pre-drilled perimeter holes.
8. Secure the pedestal to the ceiling with the three screws.
9. Use the Torx wrench to secure the three screws in external enclosure to the pedestal.
10. Make the proper wiring connections and supply power to the camera.

## 5 Network Configuration

Dahua IP cameras feature a built-in Web interface to control all aspects of camera operation. This section includes details about the supported network protocols, configuring IP addresses, and configuring alarms and local recording options. Refer to the camera's *Operations Manual* for full details.

### 5.1 Network Protocols

Dahua cameras support RTSP, RTP/TCP, RTP/UDP, HTTP, DHCP, TFTP, QoS, IP version 4 (IPv4) and IP version 6 (IPv6).

**RTSP** – Cameras communicate with video management systems over Real Time Streaming Protocol. Do not change the RTSP port unless you are sure your VMS does not use the default setting.

**RTP/TCP** – The Real-time Protocol/Transmission Control Protocol is best suited for applications that require high reliability, and transmission time is relatively less critical.

**RTP/UDP** – The Real-time Protocol/User Datagram Protocol is used for live unicast video, especially when it is important to always have an up-to-date video stream, even if some images are dropped.

**HTTP** – The Hypertext Transfer Protocol is an application protocol for distributed, collaborative, hypermedia information systems.

**DHCP** – The Dynamic Host Configuration Protocol allows network administrators to centrally manage and automate the assignment of IP addresses. DHCP should only be enabled if using dynamic IP address notification, or if the DHCP can update a DNS server.

**TFTP** – The Trivial File Transfer Protocol is a simple, lock-step, File Transfer Protocol which allows a client to get from or put a file onto a remote host. TFTP lacks security and most of the advanced features offered by more robust file transfer protocols such as File Transfer Protocol.

**QoS** – Quality of Service guarantees a certain level of a specified resource to selected traffic on a network. A QoS-aware network prioritizes network traffic and provides a greater network reliability by controlling the amount of bandwidth an application may use.

**IPv4** – The IPv4 (IP version 4) is enabled by default and obtains the IP address automatically. The address can be used to allow or block network traffic that matches a specified address or protocol. The IP address must be valid for the network. For more information, contact your network administrator.

**IPv6** – A typical IPv6 (IP version 6) node address consists of a prefix and an interface identifier (total 128 bits). The prefix is the part of the address where the bits have fixed values or are the bits that define a subnet. A typical IPv6 address may resemble the following example: 2001:db8::52:1:1. The IP address must be valid for the network. Before making changes to the IPv6 address, consult with your network administrator.

## 5.2 Modifying the IP Address

To operate the camera in your network you must assign it a valid network IP address. The default IP address is 192.168.1.108, but you may have to change this address if it conflicts with another device on the network.

To properly configure the camera for your network, you need the following information:

- Camera IP address – This address is an identifier for the camera on an IP network. For example, 140.11.2.115 is valid syntax for an IP address.
- Subnet mask – A mask is used to determine the subnet an IP address belongs to.
- Gateway IP address – This address is a node on a network that serves as an entrance to another network.
- Port – A port is an endpoint to a logical connection in an IP network.

Dahua supplies the ConfigTool to access and to modify the network settings of a device. Refer to the Operation Manual, available on the CD included with the camera or on [Dahuasecurity.com](http://Dahuasecurity.com), for complete information.

### Notes:

- Ensure that the network parameters of each camera is available before starting configuration.
- The ConfigTool supports those cameras that are part of the same network that as the computer running the ConfigTool.

## 5.3 Using the ConfigTool

1. Install the ConfigTools.exe on a computer.
1. Adjust the computer's network settings so that it is on the same network as the camera.
2. Launch the ConfigTool to generate a list of devices on the network.
3. Double click the device to be configured, the ConfigTool opens the Login dialog box for the device.
4. Enter the IP address, Username, Password, and Port number of the camera, then click OK.  
Note: the default Username and Password for the device is "admin" and "admin" respectively. The default port is 37777.

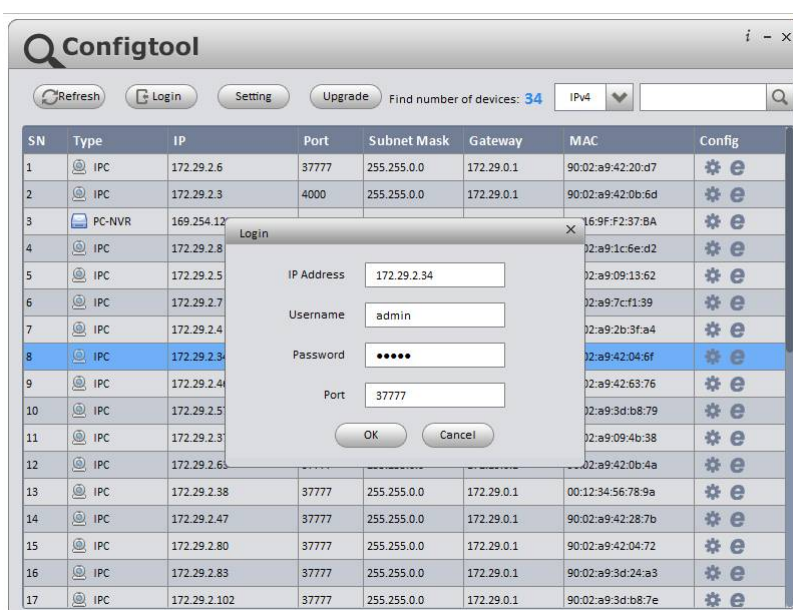

Figure 5-1

5. Click the Net icon at the top of the ConfigTool.
6. Modify the IP Address and any other applicable network parameter.
7. Click Save to finish modification and store the modified network parameters.

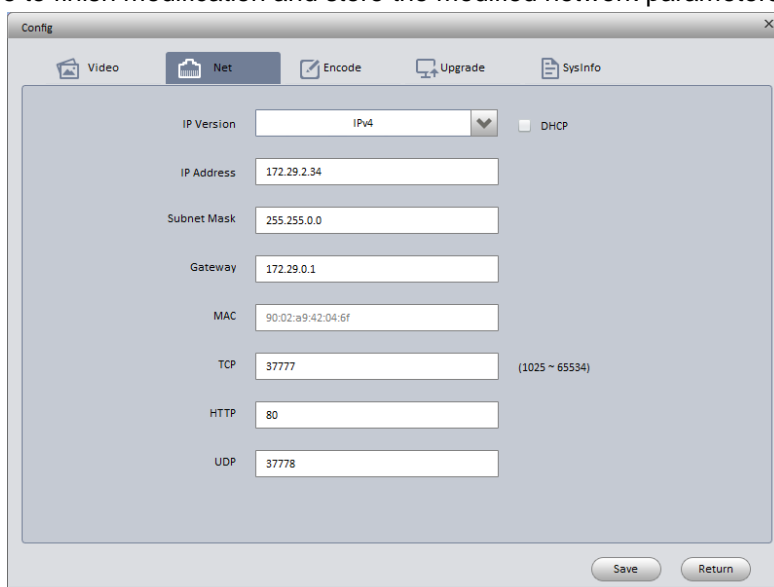

Figure 5-2

## 5.4 Accessing the Web Interface

Each camera can be accessed directly from the Internet Explorer Web browser. The Web Interface allows you to set camera parameter, configure alarm inputs and outputs, view live camera images, and review recorded video.

**Note:** Different devices may have different Web interfaces, the figures below are for reference only, and may not represent the Web Interface for your camera. Refer to the Web Operation Manual, included on the CD shipped with the camera, for more details.

2. Launch Internet Explorer and type the modified camera IP address in the address bar. Internet Explorer opens the Login page.
8. Type the Username and Password for the camera. (The default Username and Password is "admin"). Then, click Login.

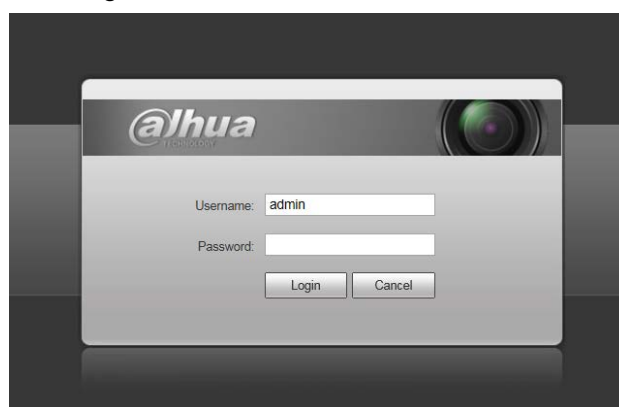

Figure 5-3

9. Install the controls according to the system prompt. Once the controls are installed IE displays the Web Interface main page.
10. Modify the administrator password as soon as possible after you successfully logged in.

## 5.5 Configuring Local SD Card Recording

The devices Web interface contains settings to control the recording medium and to configure an alarm that triggers once the Micro SD card passes a pre-determined storage.

1. Access the Web Interface for the device and click the Setup tab. Expand the Storage menu, then choose the Destination page.

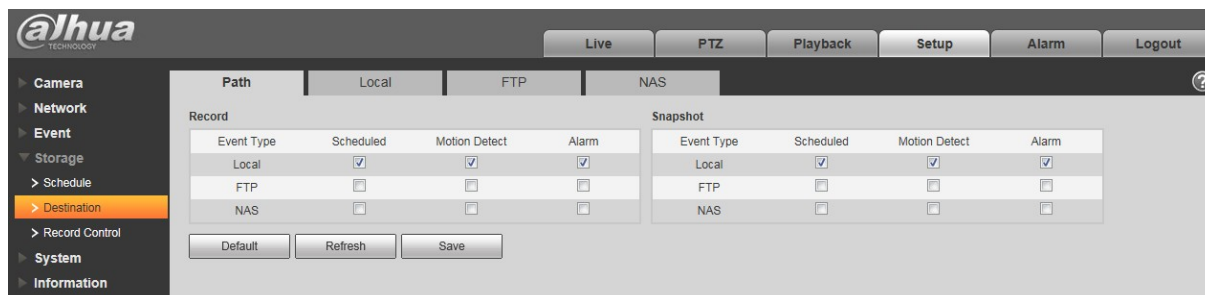

Figure 5-4

2. Select the recording medium for each event Recorded and Snapshot event, Scheduled, Motion Detect and Alarm. Select the Local check box to record an event to the Micro SD card.
3. Click the Local tab to view the used capacity and the total capacity of the Micro SD card.

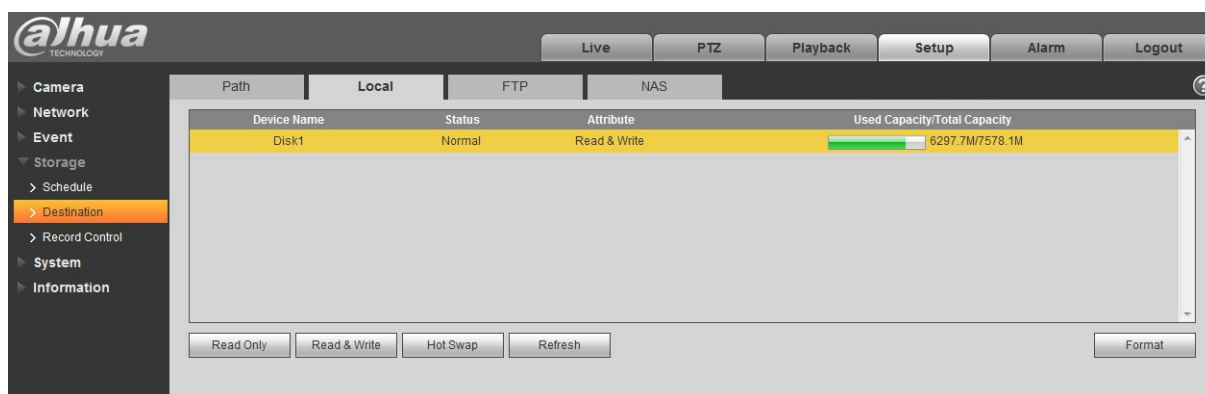

Figure 5-5

4. Expand the Event menu, located at the left of the Web interface, then select the Abnormality page to set alarms related to the Micro SD card. The contains the following Micro SD card alarm options:
  - No SD Card: Device triggers an alarm if the device does not contain a Micro SD card.
  - Capacity Warning: Device triggers an alarm when the data on the Micro SD card passes a defined threshold.
  - SD Card Error: Device triggers an alarm if it detects an issues writing data or retrieving data from the Micro SD card.



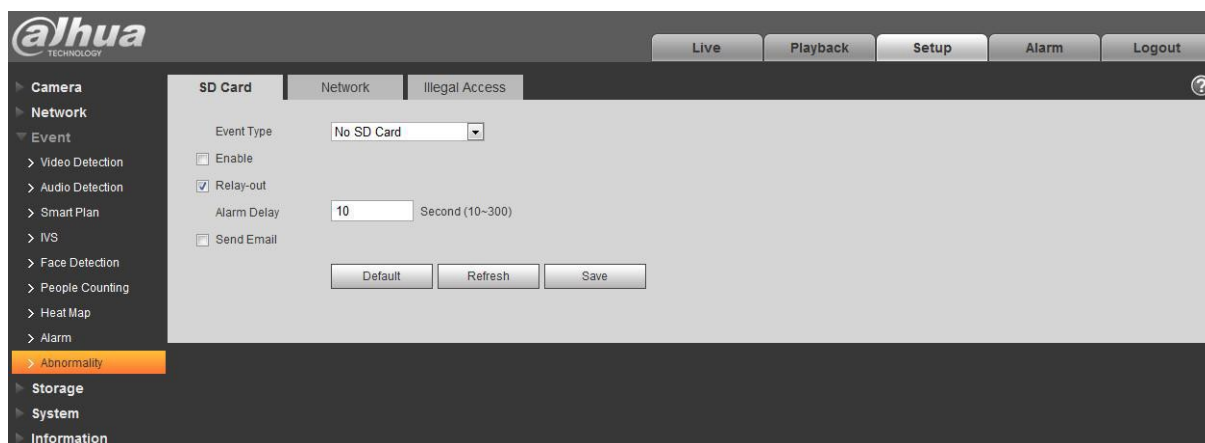

Figure 5-6

5. Select the event from the Event Type pull-down menu (No SD Card, Capacity Warning, SD Card Error).
6. Check the Enable box to activate the alarm for this event.
7. Check the Relay-out box to enable a relay alarm. Then, specify the time in seconds to delay the alarm relay output (10 s to 300 s).
8. Check the Send Email box to send an email to a specified user after the device triggers an alarm.
9. Set the capacity limit for the Micro SD Card (available with the Capacity Warning event type). The device triggers an alarm once the amount of data on the card surpasses this limit.



Figure 5-7

**Dahua Technology USA Inc.**

23 Hubble, Irvine, CA 92618

Tel: (949) 679-7777

Fax: (949) 679-5760

Email: [sales.usa@global.dahuatech.com](mailto:sales.usa@global.dahuatech.com)

Rev 001.001 © 2018 Dahua. All rights reserved. Design and specifications are subject to change without notice.